

1: 8.5 ↓	6: 9.6 →	Serie	91
2: 9.5 →	7: 9.7 ↓		
3: 9.8 ↓	8: 9.9 ↓	Total	0
4: 9.8 →	9: 10.4 ↓		
5: 9.7 ↓	10: 10.2 →		

11: 10.2 →	Serie	38
12: 9.9 ←		
13: 9.9 ↓	Total	0
14: 10.6x →		

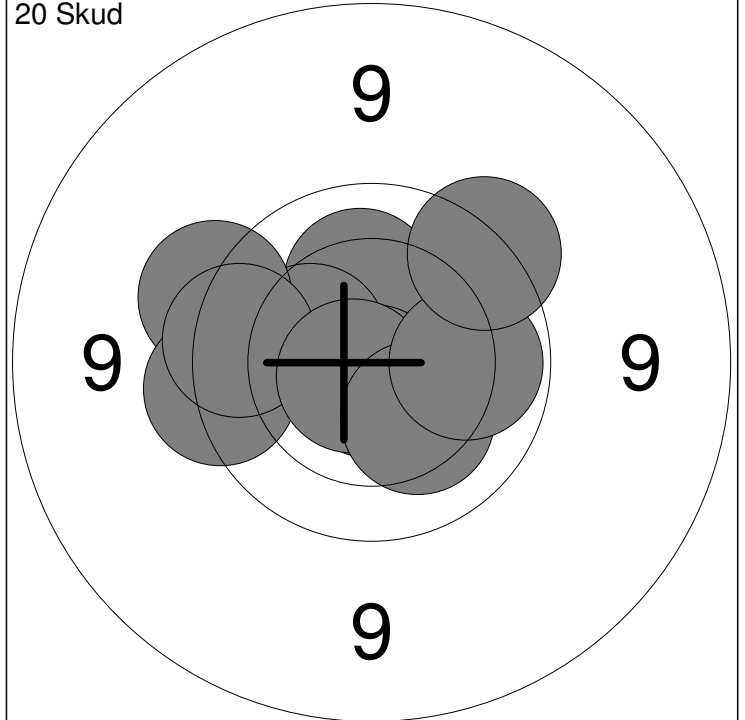
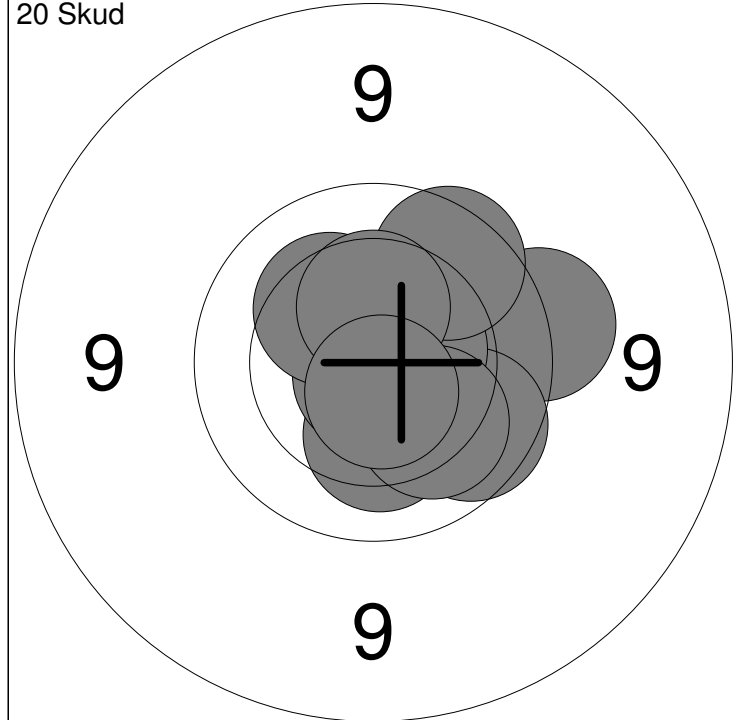

1: 9.6 →	6: 10.8x ↓	Serie	97
2: 10.2 ↓	7: 9.8 ↗		
3: 9.9 ↘	8: 10.3 ↗	Total	97
4: 10.6x →	9: 10.4 ↑		
5: 10.1 ↓	10: 10.6x ↓		

11: 10.2 ↑	16: 9.8 ←	Serie	96
12: 10.3 ←	17: 10.7x ↙		
13: 9.6 ←	18: 10.2 ↓	Total	193
14: 9.7 ←	19: 10.0 →		
15: 10.8x ↓	20: 9.6 ↗		

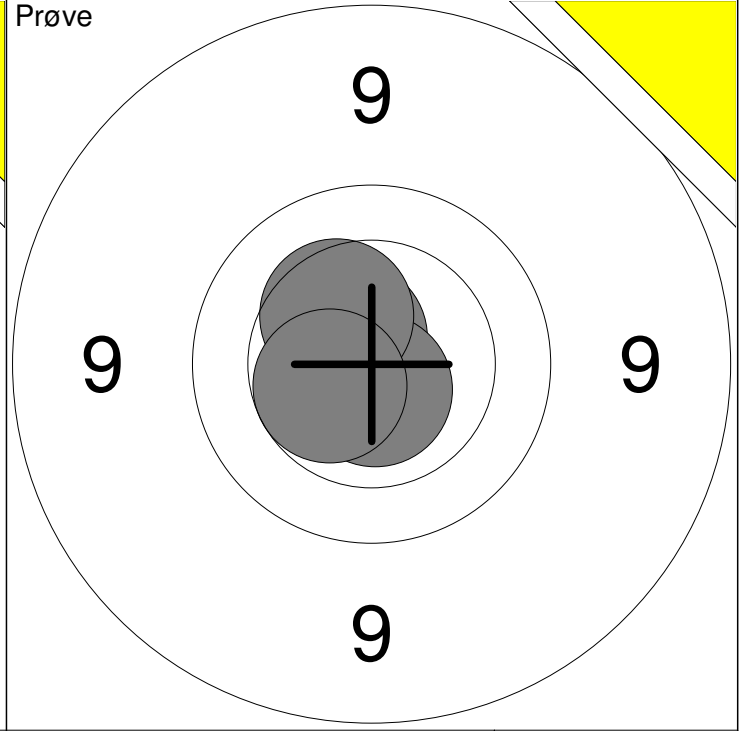
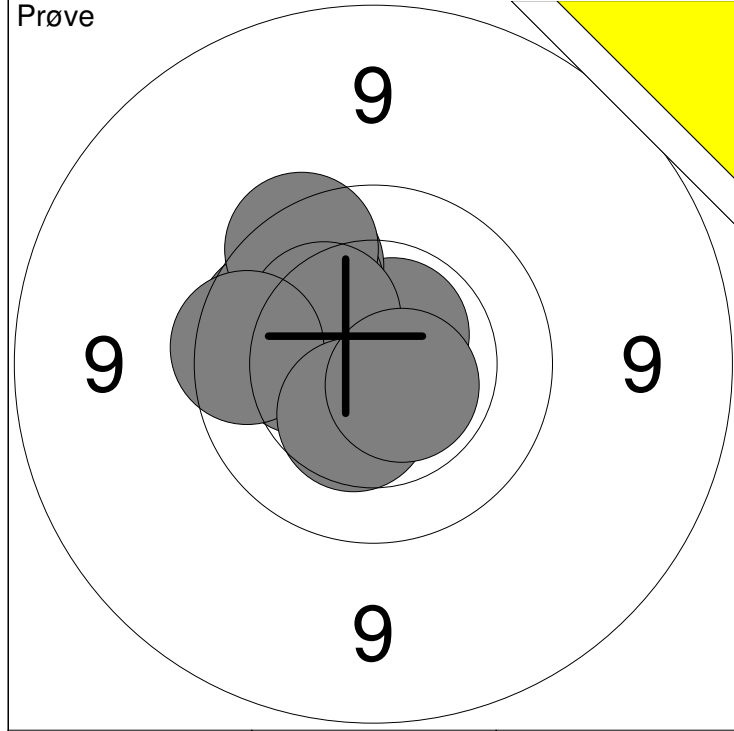

1: 10.3 ←	6: 9.8 ↗	Serie	96
2: 10.6x ↗	7: 10.3 ↗		
3: 9.9 ↗	8: 9.8 ←	Total	0
4: 10.0 ↗	9: 10.4 ↓		
5: 9.9 ←	10: 10.6x ↘		

11: 10.6x ↗	Serie	40
12: 10.7x ↓		
13: 10.4 ↗	Total	0
14: 10.5x ←		

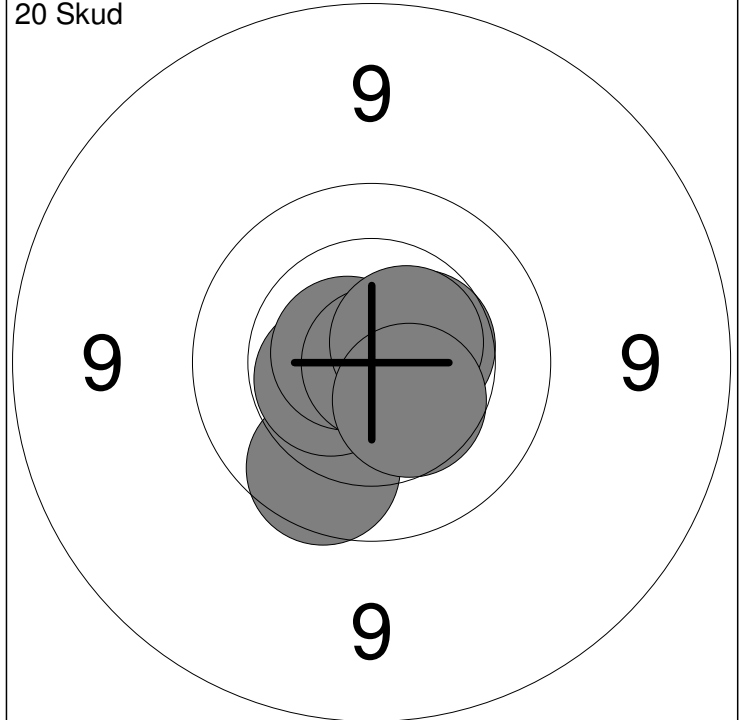
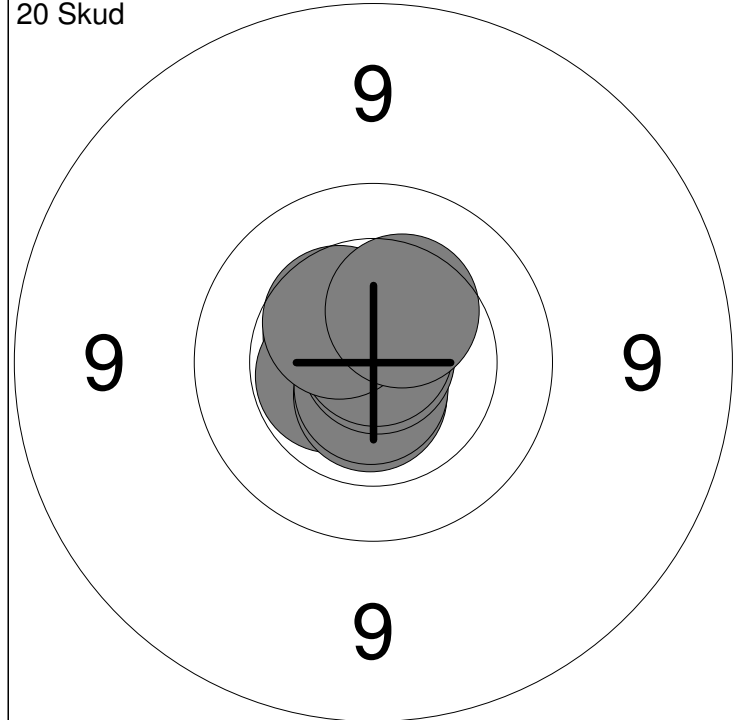

1: 10.5x ↗	6: 10.7x ↓	Serie	100
2: 10.5x ←	7: 10.9x ↗		
3: 10.5 ↗	8: 10.8x ↗	Total	100
4: 10.6x ↓	9: 10.4 ↗		
5: 10.9x ↗	10: 10.4 ↗		

11: 10.8x ↓	16: 10.7x ←	Serie	99
12: 10.7x ↓	17: 10.5 →		
13: 10.6x ↓	18: 10.9x →	Total	199
14: 9.9 ↓	19: 10.6x ↗		
15: 10.5x ←	20: 10.4 ↓		

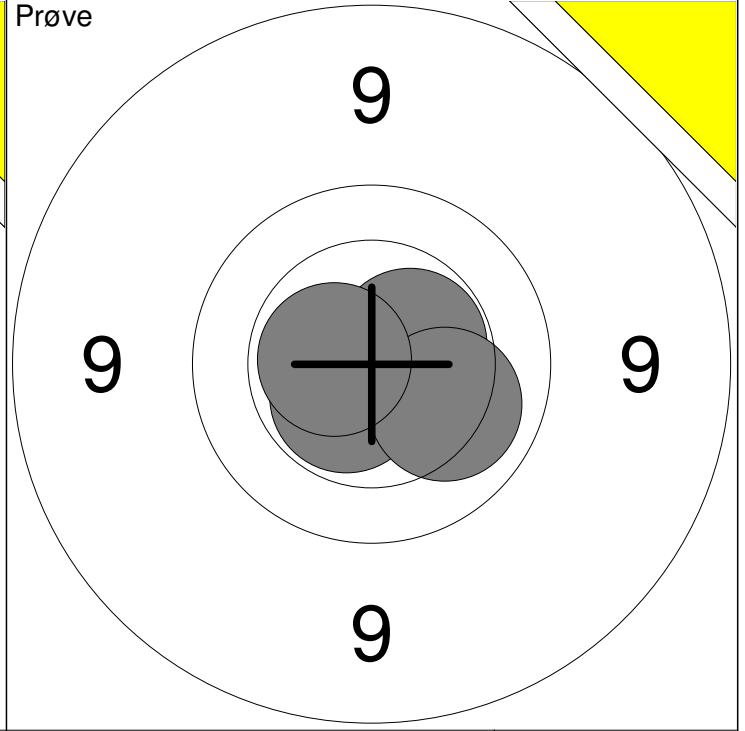
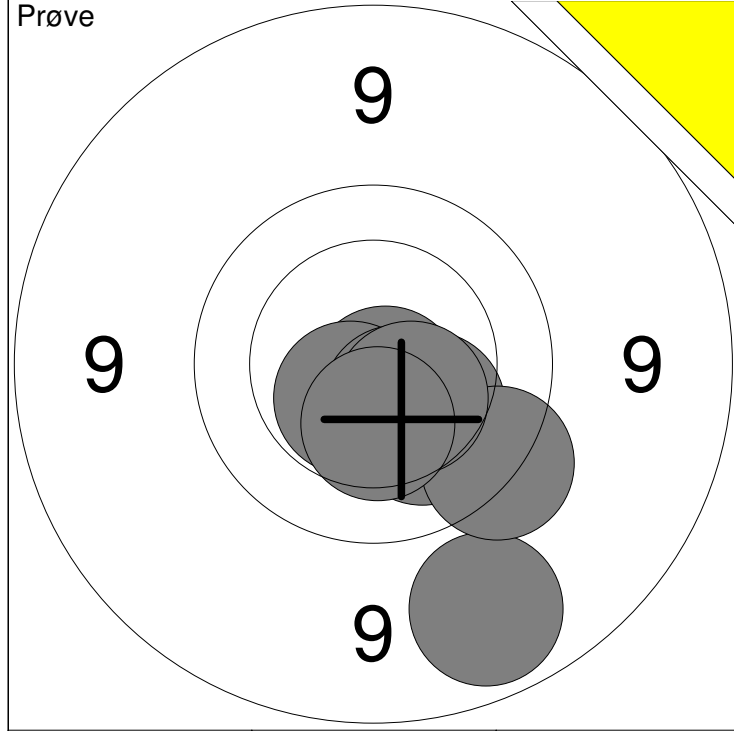

1: 9.0 ↓	6: 10.5x ↓	Serie	98
2: 10.4 ↓	7: 9.6 ↓		
3: 10.3 ↓	8: 10.5x ↓	Total	0
4: 10.2 ↓	9: 10.5 ↓		
5: 10.7x ↓	10: 10.4 ↓		

11: 10.6x ↓	Serie	40
12: 10.5x ↗		
13: 10.1 ↓	Total	0
14: 10.6x ←		

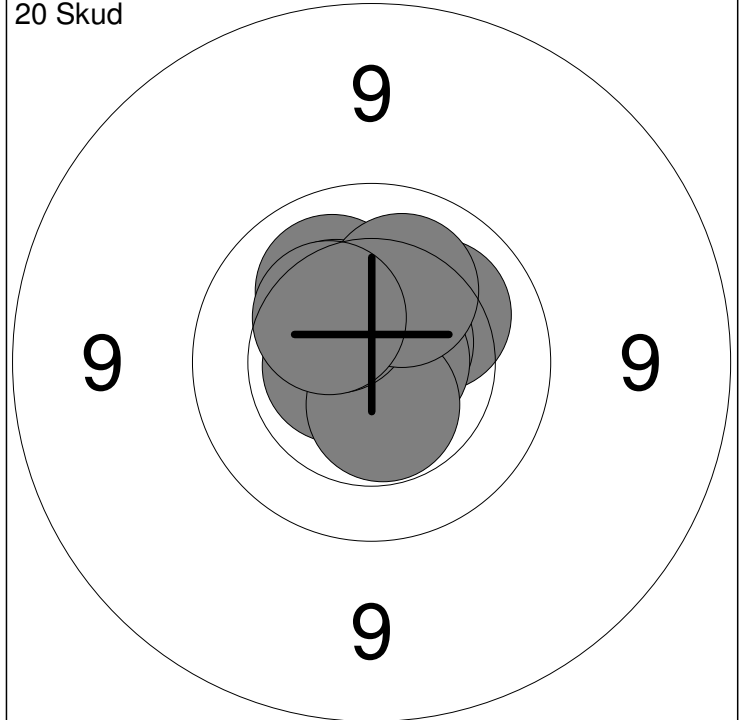
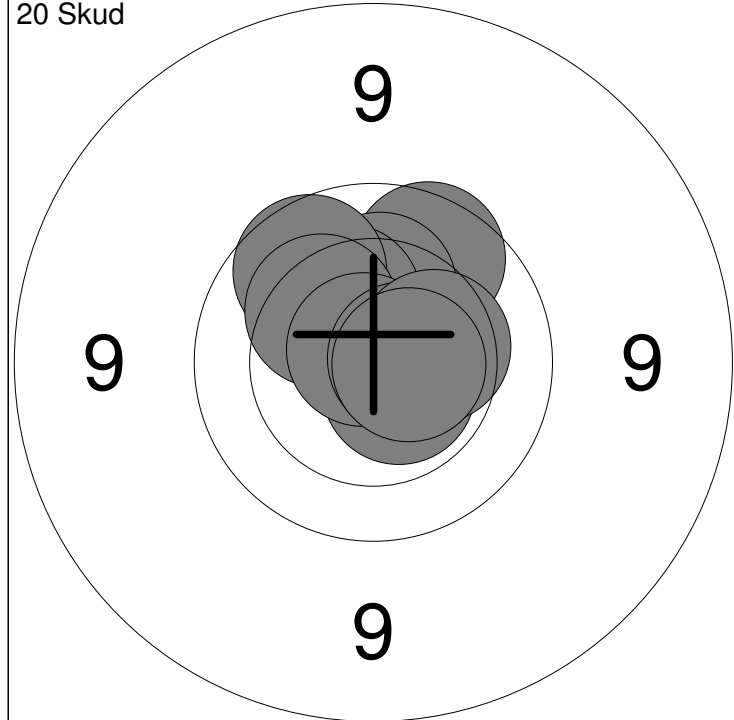

1: 9.9 ↗	6: 10.2 ↗	Serie	98
2: 10.2 ↑	7: 10.8x ↗		
3: 10.3 ↗	8: 10.6x →	Total	98
4: 9.9 ↗	9: 10.3 →		
5: 10.6x ↓	10: 10.6x →		

11: 10.2 ↗	16: 10.4 ↗	Serie	100
12: 10.1 ↗	17: 10.5x ↓		
13: 10.6x ↗	18: 10.4 ↗	Total	198
14: 10.7x →	19: 10.2 ↑		
15: 10.6x ←	20: 10.3 ↗		

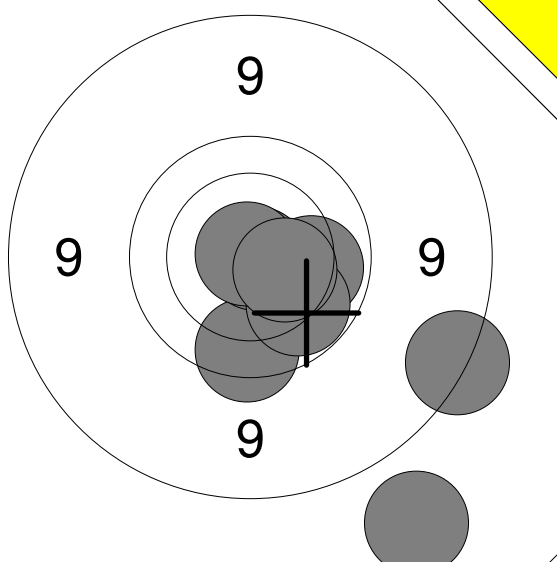
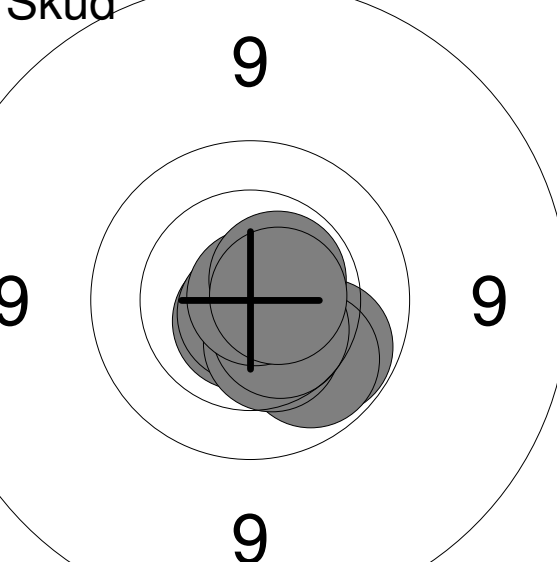
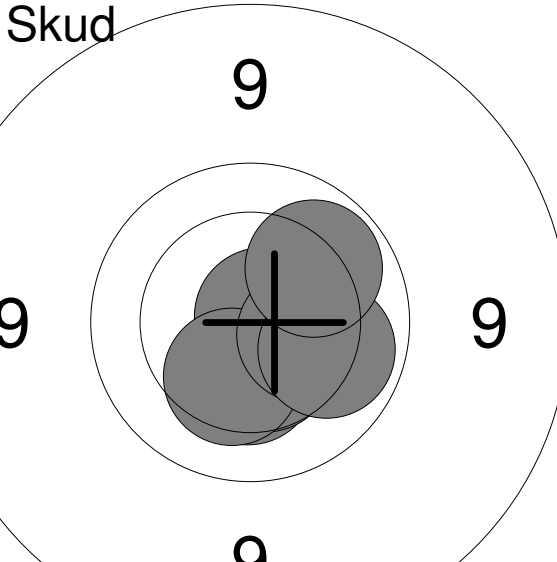
Hold <b>76</b>	Skive <b>6</b>	<b>Liva Møller</b>		
AAS		Vilsted Skf.		BK1
02.02.2017	NM 2017 ungdom riffel		Aalborg Skyttekreds	
<b>Prøve</b>				
		1: 8.3	↘	
		2: 8.7	↘	
		3: 10.0	→	
		4: 9.7	↘	
		5: 10.9x	↘	
		6: 10.0	↘	
		7: 10.9x	↗	
		8: 10.4	↘	
		<b>Serie</b>	<b>75.0</b>	
		<b>Total</b>	<b>0.0</b>	
<b>20 Skud</b>				
		1: 10.0	↘	
		2: 10.7x	↘	
		3: 10.0	↘	
		4: 10.7x	↘	
		5: 10.8x	↘	
		6: 10.4	↘	
		7: 10.5	↘	
		8: 10.9x	↗	
		9: 10.6x	↗	
		10: 10.6x	→	
		<b>Serie</b>	<b>100.0</b>	
		<b>Total</b>	<b>100.0</b>	
<b>20 Skud</b>				
		11: 10.4	↘	
		12: 10.2	→	
		13: 10.5x	↘	
		14: 10.7x	↘	
		15: 10.5	↘	
		16: 10.8x	↗	
		17: 10.3	↘	
		18: 10.3	→	
		19: 10.1	→	
		20: 10.0	↗	
		<b>Serie</b>	<b>100.0</b>	
		<b>Total</b>	<b>200.0</b>	

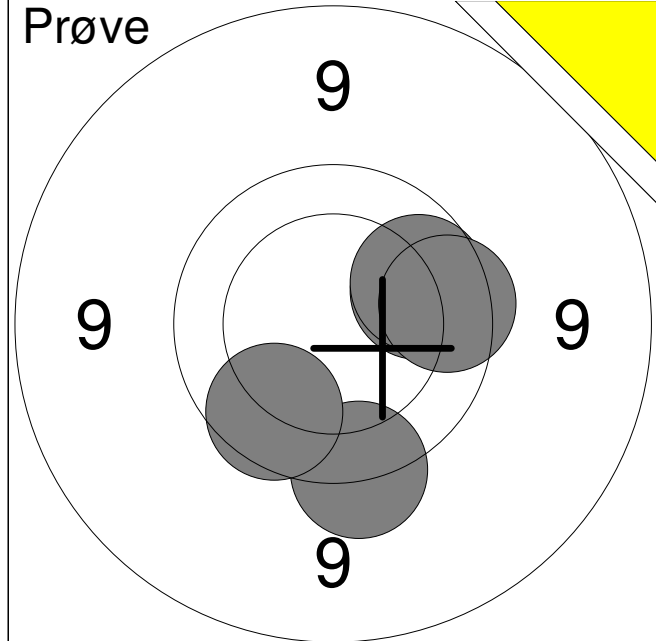

1:	9.9	→
2:	9.6	↓
3:	9.9	→
4:	9.8	→
5:	9.9	↓
<b>Serie</b>	<b>45.0</b>	
<b>Total</b>	<b>0.0</b>	

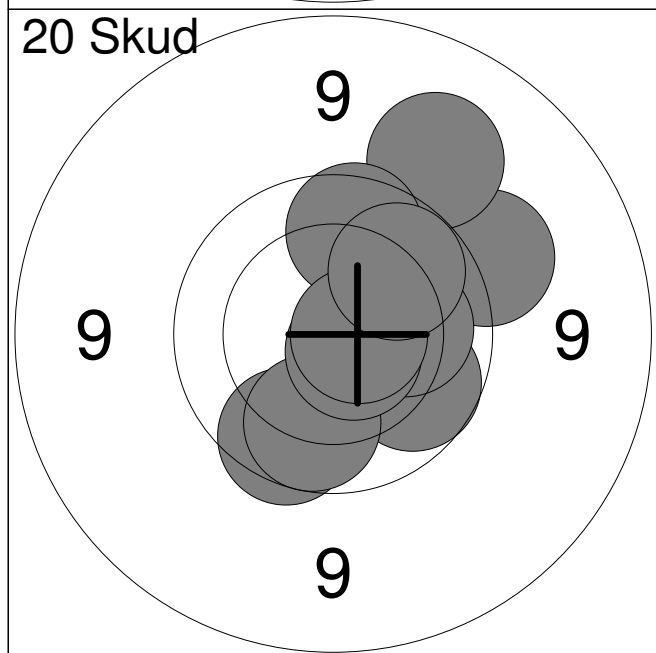

1:	9.8	↓
2:	9.9	↘
3:	9.9	↓
4:	9.4	→
5:	10.2	→
6:	9.3	↗
7:	9.9	↑
8:	10.7x	↘
9:	10.7x	→
10:	10.0	↗
<b>Serie</b>	<b>94.0</b>	
<b>Total</b>	<b>94.0</b>	

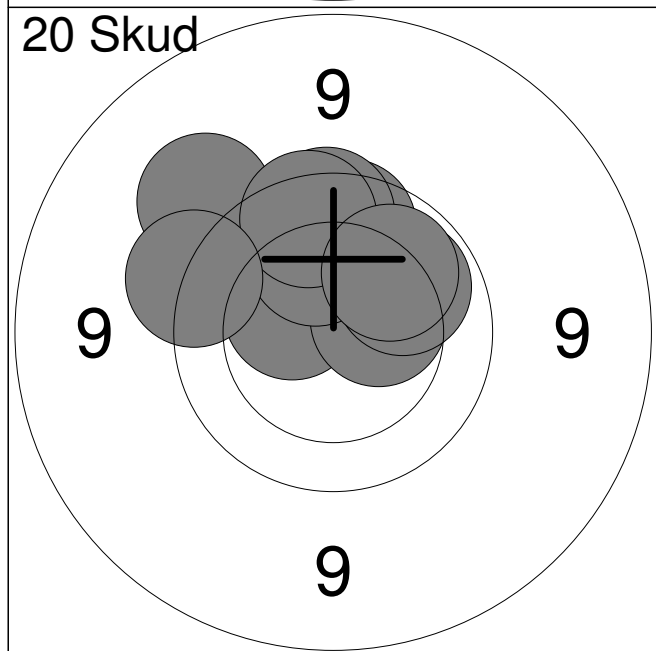

11:	10.4	↖
12:	10.4	→
13:	9.9	↑
14:	9.4	↖
15:	10.0	↗
16:	10.1	↑
17:	9.8	↑
18:	9.8	↑
19:	9.6	↖
20:	10.0	↗
<b>Serie</b>	<b>95.0</b>	
<b>Total</b>	<b>189.0</b>	

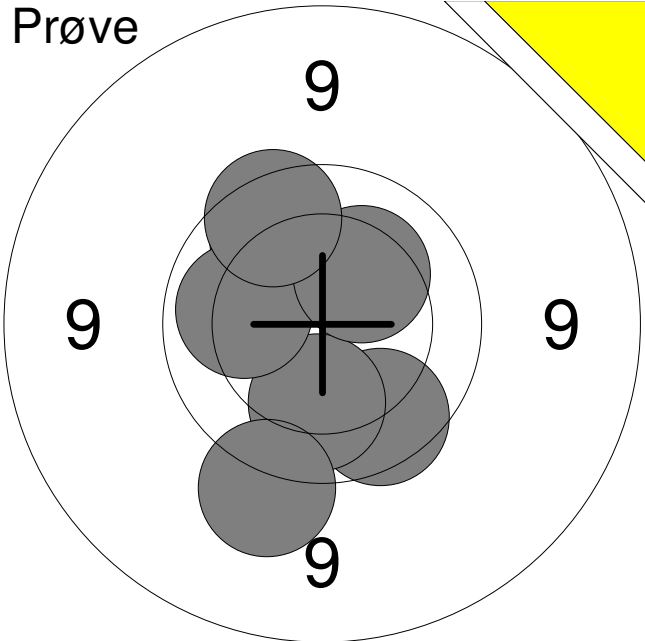
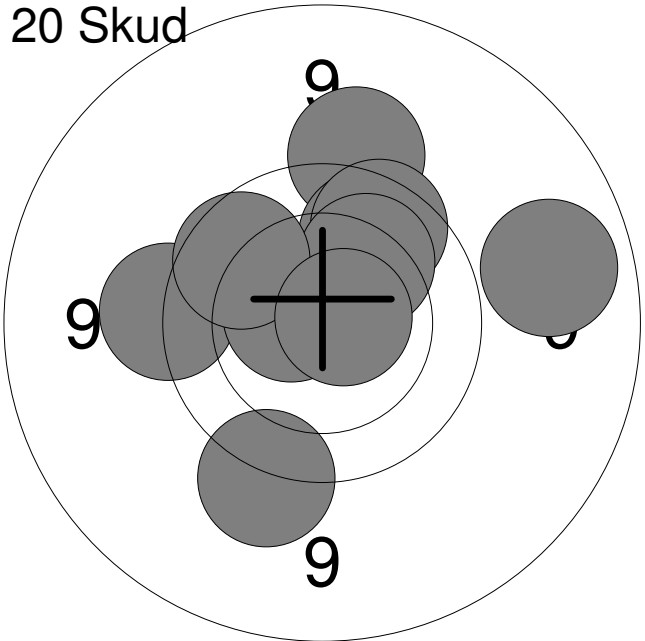
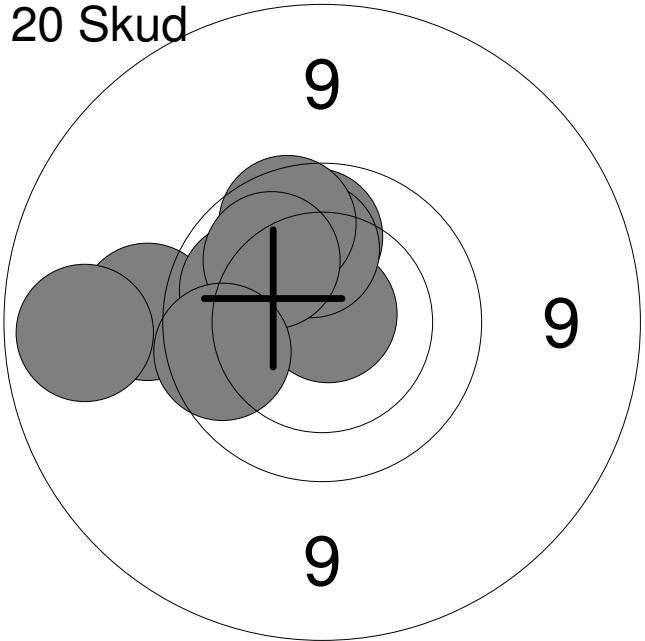
Hold	Skive	Nicklas W. Pedersen		
76	8	AAS	Hjørring Skytteforening	BK3
02.02.2017	NM 2017 ungdom riffel	Aalborg Skyttekreds		
<b>Prøve</b> 	1:	9.8	↘	
	2:	10.1	↓	
	3:	9.4	↘	
	4:	9.9	↗	
	5:	10.1	←	
	6:	10.2	↗	
	7:	9.8	↗	
	<b>Serie</b>	<b>66.0</b>		
	<b>Total</b>	<b>0.0</b>		
<b>20 Skud</b> 	1:	9.4	↑	
	2:	9.9	↗	
	3:	9.5	←	
	4:	10.6x	←	
	5:	9.8	↗	
	6:	10.1	↗	
	7:	9.1	→	
	8:	9.5	↓	
	9:	9.9	↗	
	10:	10.7x	→	
	<b>Serie</b>	<b>93.0</b>		
	<b>Total</b>	<b>93.0</b>		
<b>20 Skud</b> 	11:	10.5x	↗	
	12:	9.4	←	
	13:	10.0	↑	
	14:	10.1	←	
	15:	10.8x	↗	
	16:	9.0	←	
	17:	10.1	↑	
	18:	9.9	↗	
	19:	10.1	↗	
	20:	9.9	←	
	<b>Serie</b>	<b>96.0</b>		
	<b>Total</b>	<b>189.0</b>		

<b>Prøve</b> 	1:	9.9	↘	
	2:	9.9	↙	
	3:	10.3	↗	
	4:	9.4	→	
	5:	10.3	↗	
	6:	10.3	↘	
	7:	10.2	↖	
	8:	10.7x	↖	
	<b>Serie</b>		<b>77.0</b>	
	<b>Total</b>		<b>0.0</b>	

<b>20 Skud</b> 	1:	10.9x	↙
	2:	9.9	↗
	3:	9.7	→
	4:	10.7x	↑
	5:	10.5	↑
	6:	10.4	↖
	7:	10.3	↖
	8:	9.8	→
	9:	10.3	↑
	10:	10.3	↗
<b>Serie</b>		<b>97.0</b>	
<b>Total</b>		<b>97.0</b>	

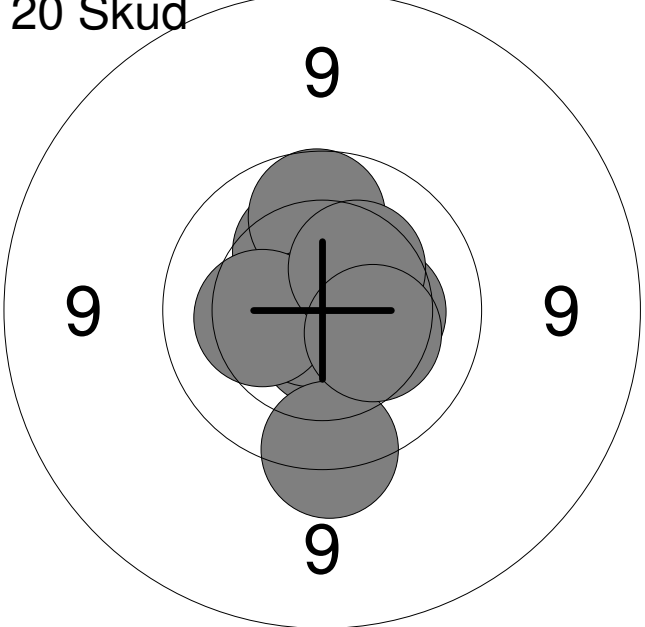
<b>20 Skud</b> 	11:	10.3	↑
	12:	10.6x	↘
	13:	10.4	↗
	14:	9.9	↑
	15:	10.8x	↖
	16:	10.3	↖
	17:	9.6	↘
	18:	10.3	→
	19:	10.3	↗
	20:	10.3	→
<b>Serie</b>		<b>98.0</b>	
<b>Total</b>		<b>195.0</b>	

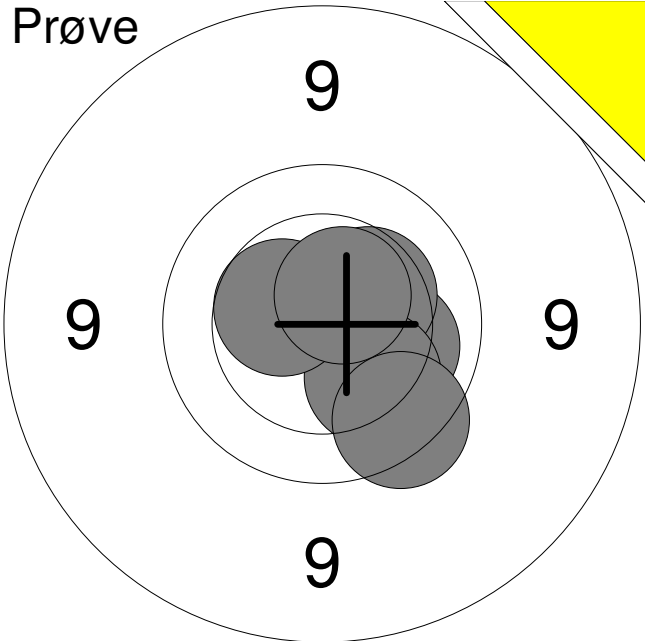
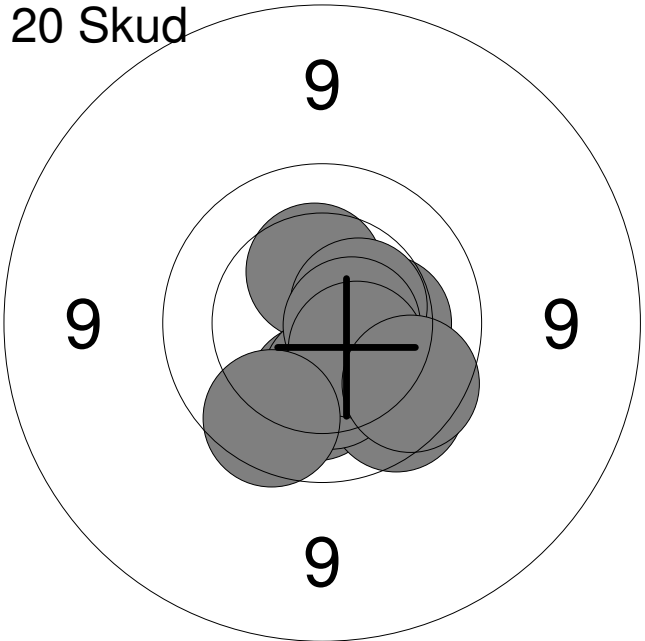
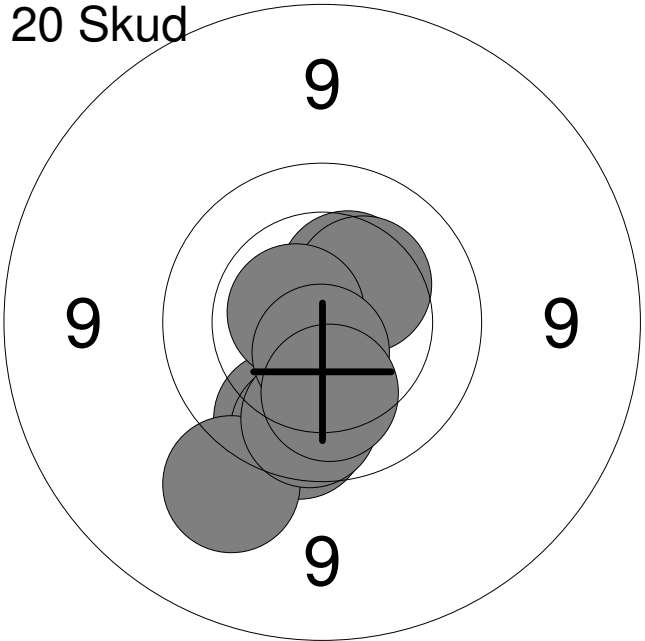
Hold <b>76</b>	Skive <b>10</b>	<b>Morten Christian Pedersen</b>		
AAS		Hjørring Skytteforening		J2
02.02.2017		NM 2017 ungdom riffel		Aalborg Skyttekreds
<b>Prøve</b>				
		1:	10.2	→
		2:	10.4	↗
		3:	10.1	↘
		4:	10.5	↖
		5:	9.7	↘
		6:	10.6x	↗
		<b>Serie</b>		<b>59.0</b>
		<b>Total</b>		<b>0.0</b>
<b>20 Skud</b>				
		1:	10.3	→
		2:	10.4	↑
		3:	10.2	↓
		4:	10.5x	↗
		5:	9.8	↘
		6:	10.3	↓
		7:	10.6x	→
		8:	10.5	↘
		9:	9.8	↘
		10:	9.8	↘
		<b>Serie</b>		<b>97.0</b>
		<b>Total</b>		<b>97.0</b>
<b>20 Skud</b>				
		11:	10.4	↓
		12:	10.4	↗
		13:	10.3	↗
		14:	9.9	↓
		15:	10.6x	↖
		16:	9.8	↓
		17:	9.4	↘
		18:	9.9	↓
		19:	10.6x	↓
		20:	10.2	↓
		<b>Serie</b>		<b>96.0</b>
		<b>Total</b>		<b>193.0</b>

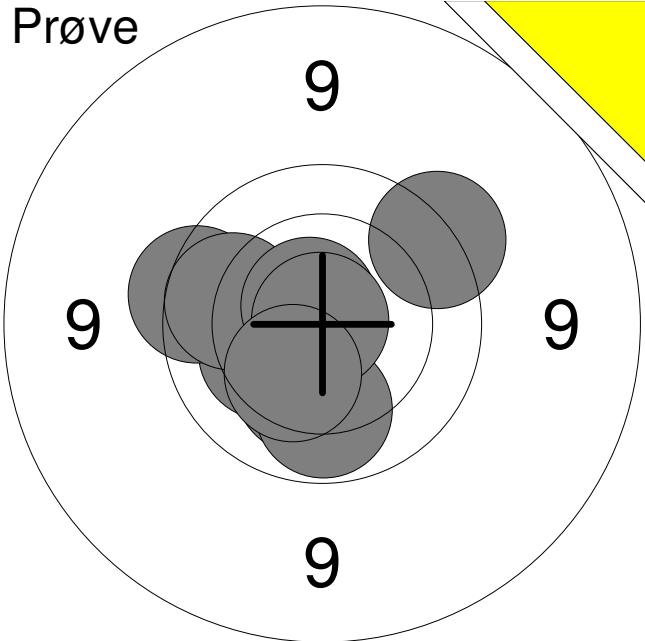
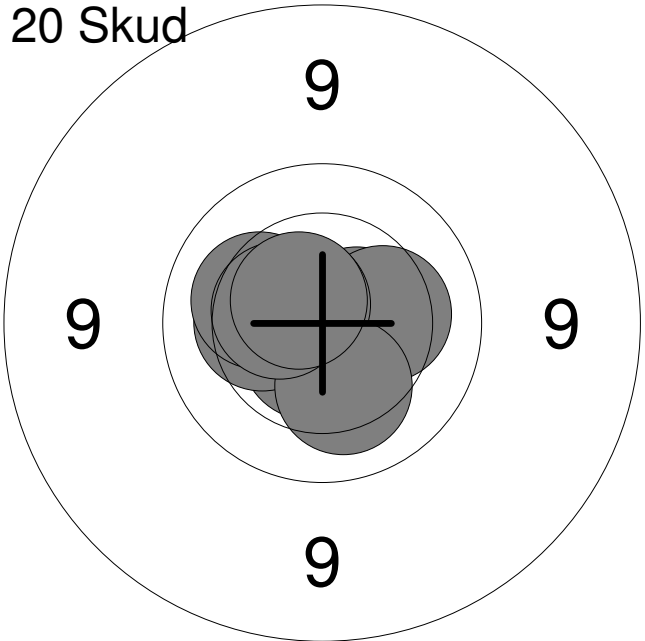
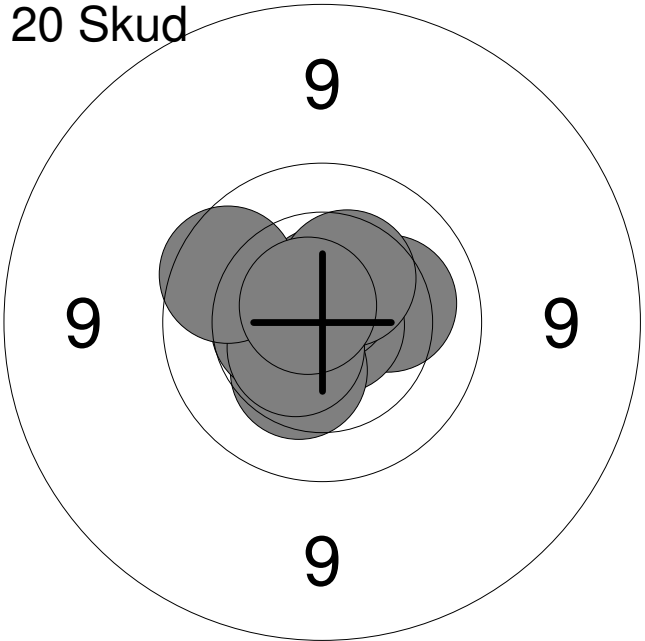

Hold	Skive	Thomas Grøn Bendixen	
76	11		
AAS		Hjørring Skytteforening	J1
02.02.2017	NM 2017 ungdom riffel	Aalborg Skyttekreds	
Prøve		1: 10.2	↓
		2: 10.0	↓
		3: 10.3	←
		4: 9.7	←
		5: 9.9	←
		6: 10.7x	↗
		7: 9.6	↗
		8: 10.9x	↗
		9: 10.3	↓
		<b>Serie</b>	<b>87.0</b>
		<b>Total</b>	<b>0.0</b>
20 Skud		1: 10.6x	↓
		2: 10.5x	←
		3: 10.3	←
		4: 10.6x	→
		5: 10.3	→
		6: 10.2	←
		7: 10.6x	↗
		8: 10.2	↓
		9: 10.5	←
		10: 10.6x	↗
		<b>Serie</b>	<b>100.0</b>
		<b>Total</b>	<b>100.0</b>
20 Skud		11: 10.6x	↗
		12: 10.2	→
		13: 10.8x	→
		14: 10.4	↓
		15: 10.5	←
		16: 10.7x	↑
		17: 10.4	↗
		18: 10.5x	↙
		19: 9.9	←
		20: 10.7x	↗
		<b>Serie</b>	<b>99.0</b>
		<b>Total</b>	<b>199.0</b>

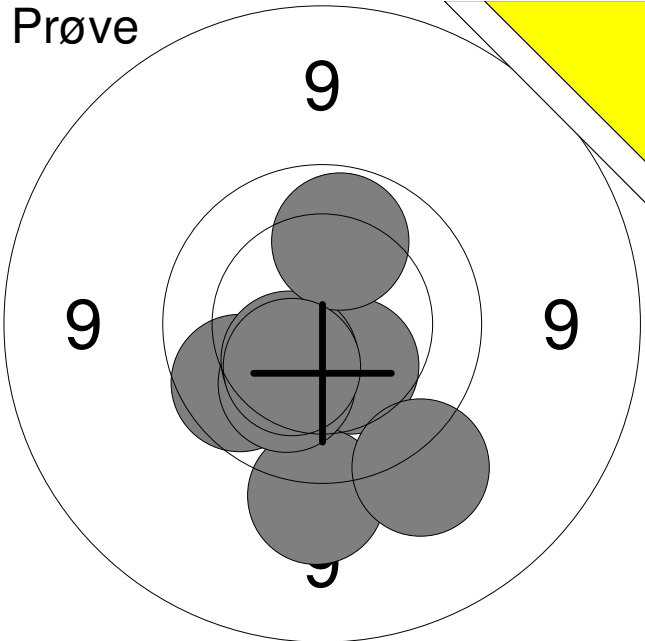
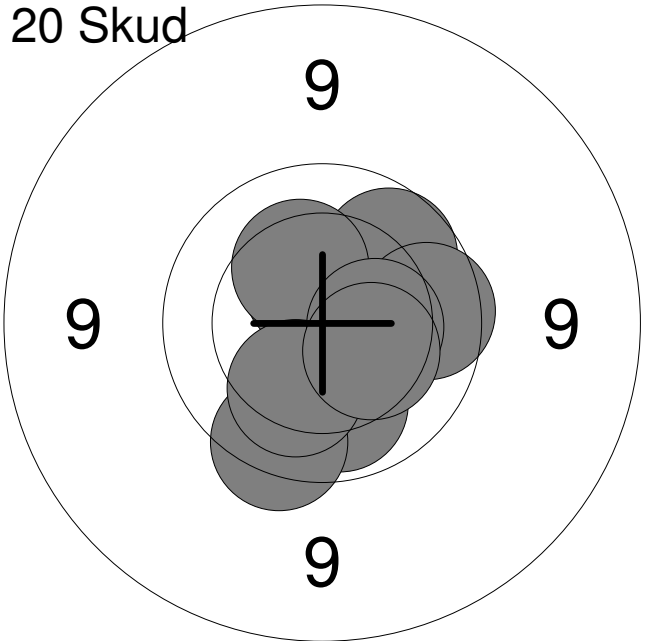
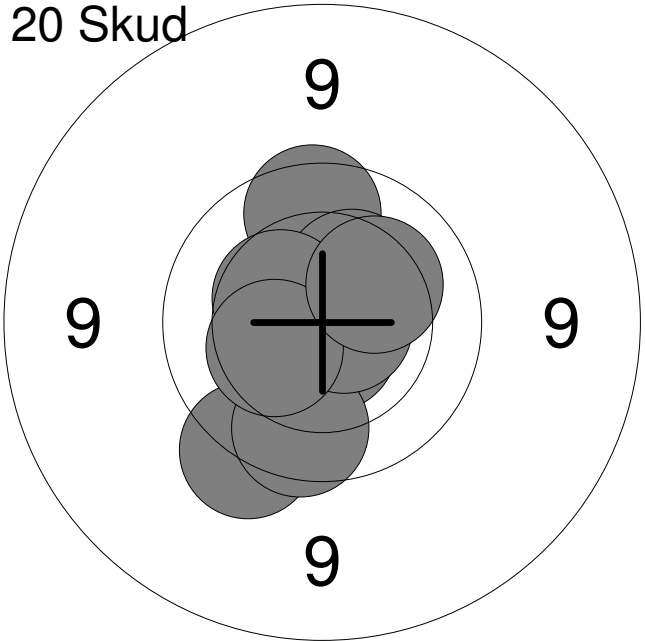
Hold	Skive	Lars Padfield	
76	12	Hjørring Skytteforening	J2
02.02.2017	NM 2017 ungdom riffel	Aalborg Skyttekreds	
Prøve		1: 10.4	↘
		2: 9.4	↓
		3: 9.9	↙
		4: 10.2	↘
		5: 9.4	↘
		6: 10.4	↙
		7: 10.0	↑
		8: 10.4	↘
		<b>Serie</b>	<b>77.0</b>
		<b>Total</b>	<b>0.0</b>
20 Skud		1: 10.5x	↑
		2: 10.4	↘
		3: 10.0	↘
		4: 9.9	↗
		5: 10.3	↑
		6: 9.7	↘
		7: 9.9	→
		8: 10.2	↘
		9: 10.4	→
		10: 10.3	↘
		<b>Serie</b>	<b>97.0</b>
		<b>Total</b>	<b>97.0</b>
20 Skud		11: 10.7x	↘
		12: 9.6	↘
		13: 9.8	↘
		14: 10.3	↑
		15: 9.8	↑
		16: 10.4	↗
		17: 10.7x	→
		18: 10.4	↙
		19: 10.4	↙
		20: 10.2	↗
		<b>Serie</b>	<b>97.0</b>
		<b>Total</b>	<b>194.0</b>

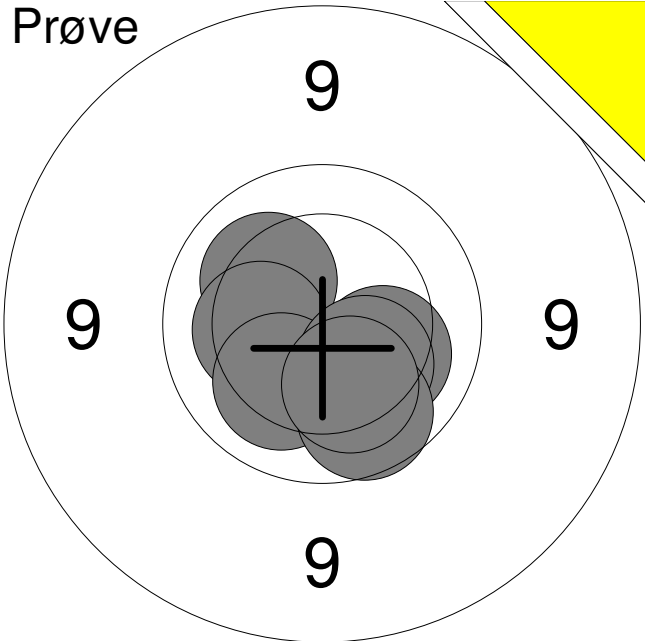
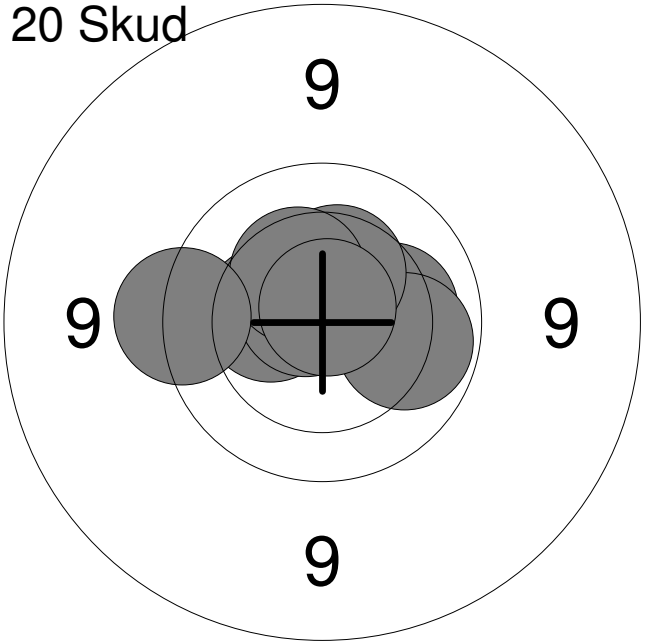
Hold	Skive		
77	1	<b>Malthe Burholt</b>	
AAS		Frederikshavn Skyttekreds	BK2
02.02.2017	NM 2017 ungdom riffel	Aalborg Skyttekreds	
<b>Prøve</b>		1: 10.2	↗
		2: 10.3	←
		3: 10.2	↘
		4: 10.2	↘
		5: 10.3	↘
		6: 9.9	↘
		7: 10.2	↘
		<b>Serie</b>	<b>69.0</b>
		<b>Total</b>	<b>0.0</b>
<b>20 Skud</b>		1: 10.4	↘
		2: 10.4	→
		3: 10.4	↘
		4: 10.2	←
		5: 10.5	↘
		6: 10.5x	↘
		7: 10.1	↘
		8: 10.3	↘
		9: 10.4	↑
		10: 10.4	↑
		<b>Serie</b>	<b>100.0</b>
		<b>Total</b>	<b>100.0</b>
<b>20 Skud</b>		11: 10.2	→
		12: 10.7x	↑
		13: 10.7x	↑
		14: 10.4	←
		15: 10.0	→
		16: 10.4	↑
		17: 10.7x	↑
		18: 10.4	↑
		19: 10.8x	↑
		20: 9.6	←
		<b>Serie</b>	<b>99.0</b>
		<b>Total</b>	<b>199.0</b>

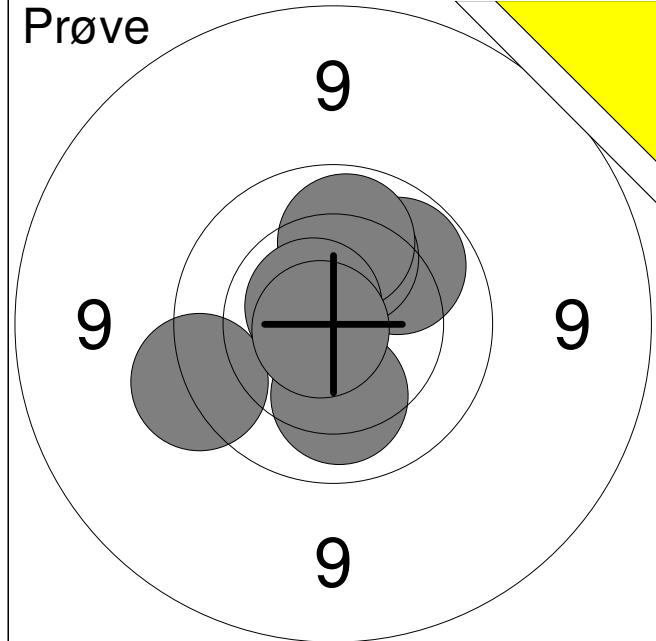

1:	10.0	↗
2:	10.2	↑
3:	10.0	↑
4:	10.2	↓
5:	9.6	←
6:	10.7x	↗
7:	10.8x	←
<b>Serie</b>		<b>69.0</b>
<b>Total</b>		<b>0.0</b>

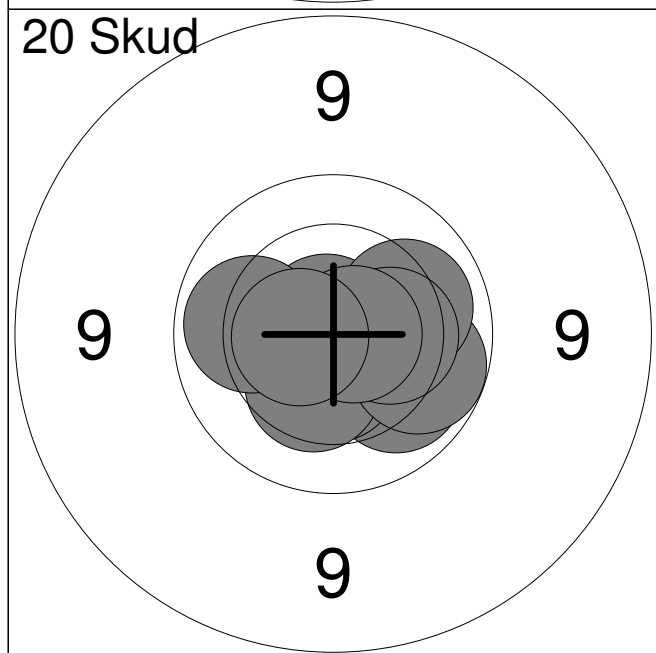

1:	10.1	↘
2:	10.8x	↗
3:	10.5x	↓
4:	10.4	↓
5:	10.0	→
6:	10.1	→
7:	10.1	←
8:	10.3	→
9:	10.7x	→
10:	10.6x	←
<b>Serie</b>		<b>100.0</b>
<b>Total</b>		<b>100.0</b>

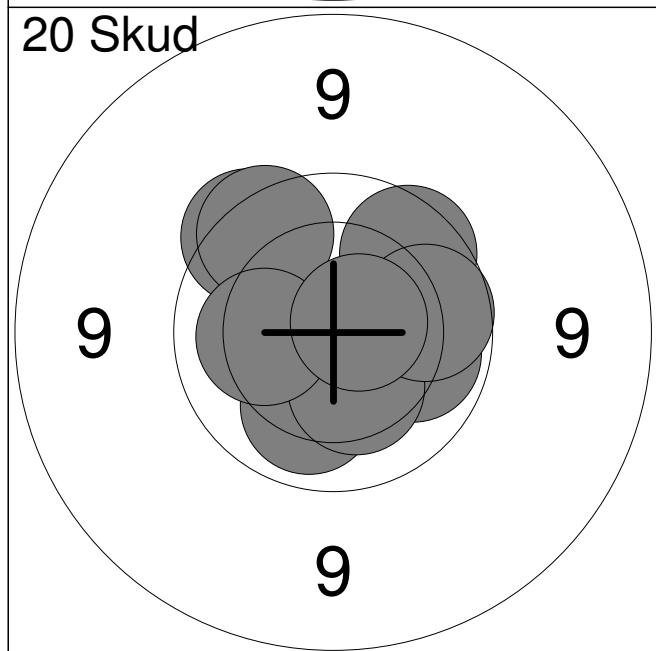

11:	10.1	↓
12:	10.0	→
13:	10.6x	↓
14:	10.3	↓
15:	9.8	↗
16:	9.7	↗
17:	9.9	→
18:	9.8	↗
19:	10.2	←
20:	10.6x	→
<b>Serie</b>		<b>96.0</b>
<b>Total</b>		<b>196.0</b>

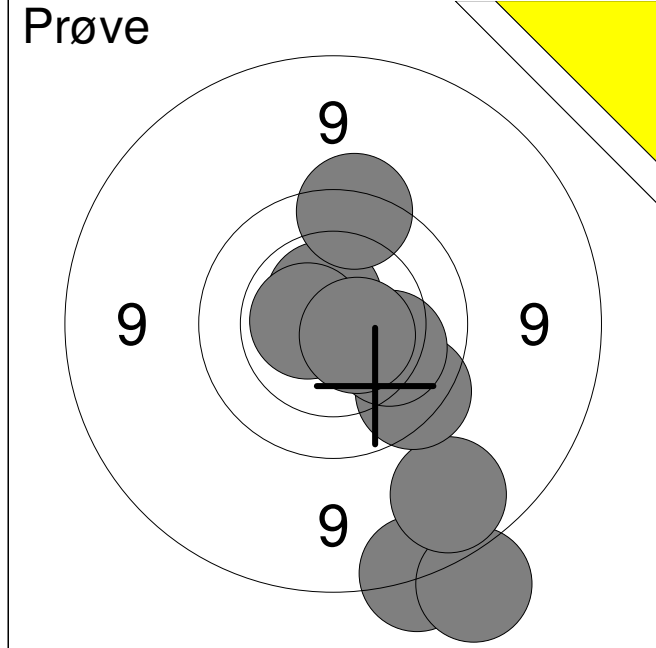

1:	8.7	↘
2:	8.5	↘
3:	9.0	↘
4:	9.7	↘
5:	10.6x	↗
6:	9.7	↗
7:	10.1	↘
8:	10.6x	←
9:	10.6x	↘
<b>Serie</b>		<b>83.0</b>
<b>Total</b>		<b>0.0</b>

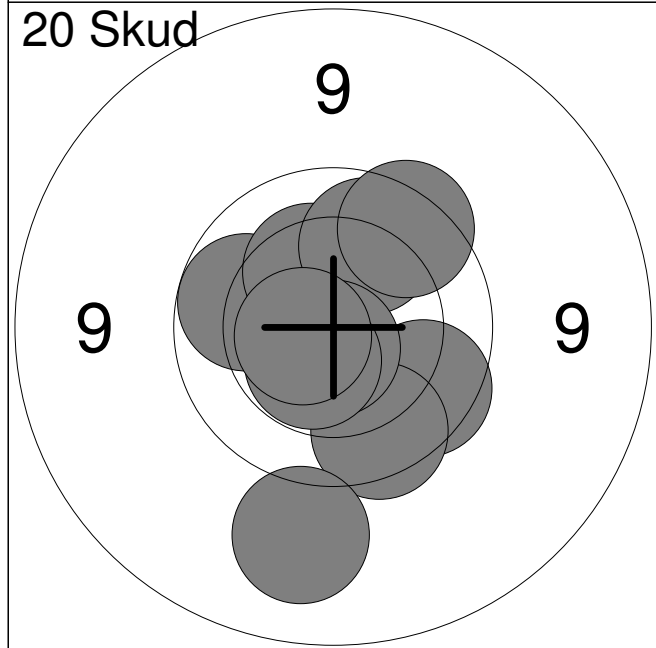

1:	9.9	←
2:	10.3	↗
3:	9.8	↘
4:	10.0	↗
5:	9.8	↘
6:	9.8	↗
7:	9.2	↘
8:	10.7x	↘
9:	10.5x	↘
10:	10.6x	←
<b>Serie</b>		<b>95.0</b>
<b>Total</b>		<b>95.0</b>

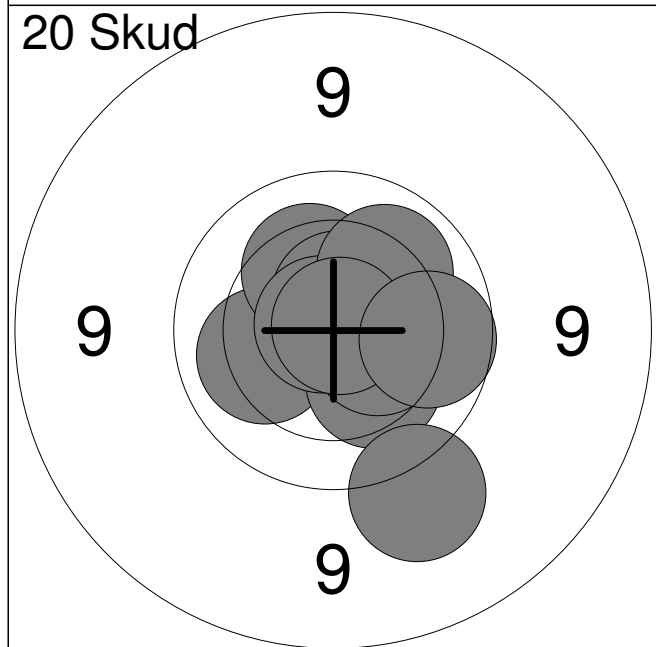

11:	10.2	←
12:	10.2	↘
13:	10.3	↗
14:	10.6x	↗
15:	10.4	↘
16:	10.8x	↗
17:	9.4	↘
18:	10.1	↗
19:	10.9x	↗
20:	9.9	→
<b>Serie</b>		<b>98.0</b>
<b>Total</b>		<b>193.0</b>

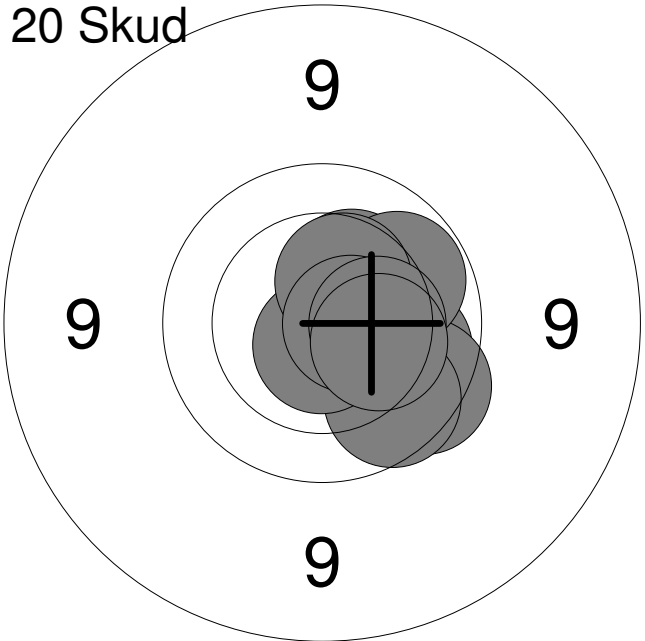
Hold	Skive	Magnus Neist	
77	5	Frederikshavn Skyttekreds	BK2
02.02.2017	NM 2017 ungdom riffel	Aalborg Skyttekreds	
Prøve		1: 10.0	↓
		2: 9.9	←
		3: 10.2	↘
		4: 10.0	↓
		5: 10.1	↓
		6: 10.4	→
		7: 9.9	↗
		8: 10.2	←
		9: 10.5x	↓
		<b>Serie</b>	<b>88.0</b>
		<b>Total</b>	<b>0.0</b>
20 Skud		1: 10.4	↗
		2: 10.0	→
		3: 9.8	↘
		4: 10.0	↗
		5: 9.9	↓
		6: 10.7x	↓
		7: 10.4	↗
		8: 10.6x	→
		9: 10.3	→
		10: 10.3	→
		<b>Serie</b>	<b>98.0</b>
		<b>Total</b>	<b>98.0</b>
20 Skud		11: 10.8x	↙
		12: 10.1	↑
		13: 10.6x	↑
		14: 9.0	↗
		15: 10.0	↘
		16: 9.8	↘
		17: 9.8	↗
		18: 9.7	→
		19: 9.9	→
		20: 9.9	↘
		<b>Serie</b>	<b>94.0</b>
		<b>Total</b>	<b>192.0</b>

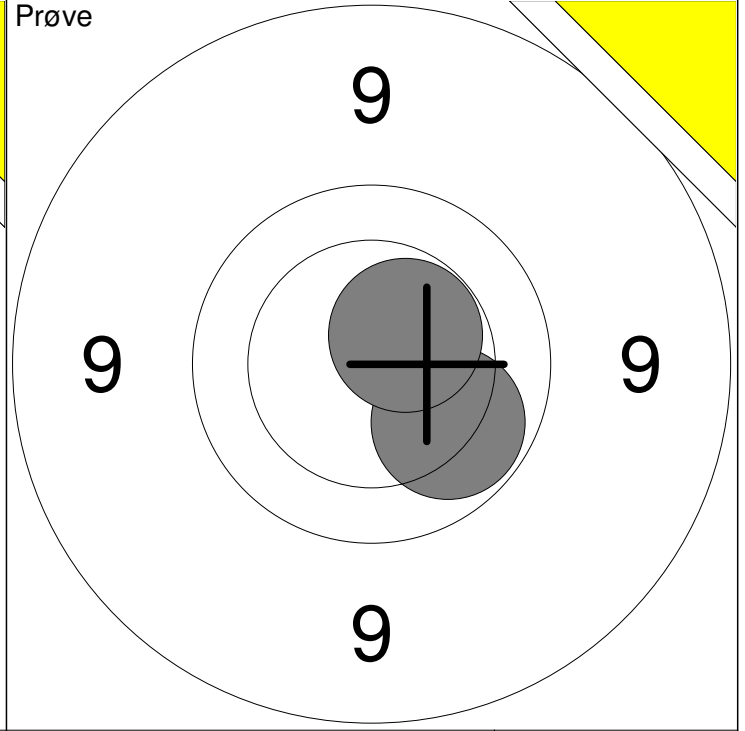
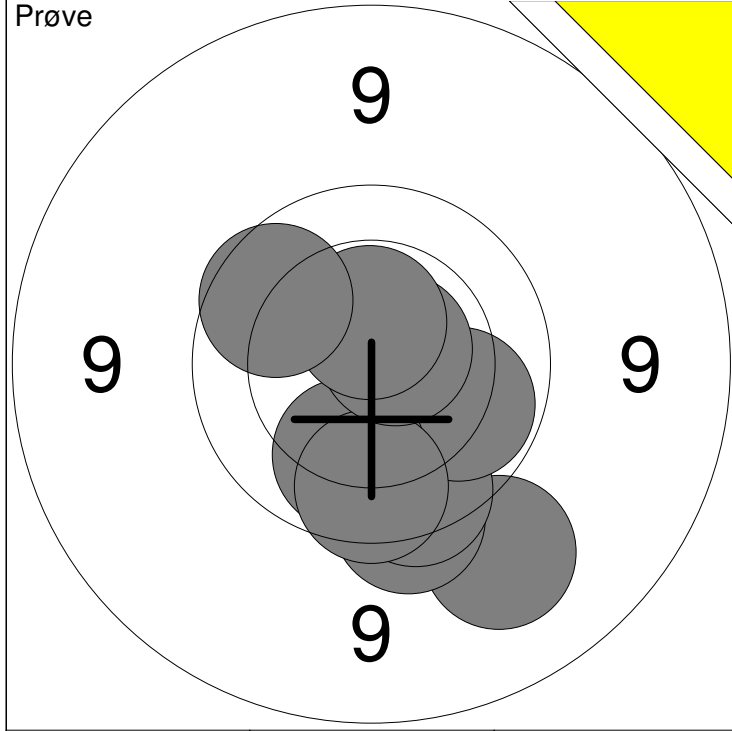

1: 9.2 ↘	6: 10.0 ↓	Serie	94
2: 9.9 ↘	7: 9.8 ↓		
3: 9.6 ↘	8: 10.7x ↗	Total	0
4: 9.8 ↘	9: 10.5x ↑		
5: 10.0 ↘	10: 9.9 ↖		

11: 10.0 ↘	Serie	20
12: 10.5x ↗		
Total		0

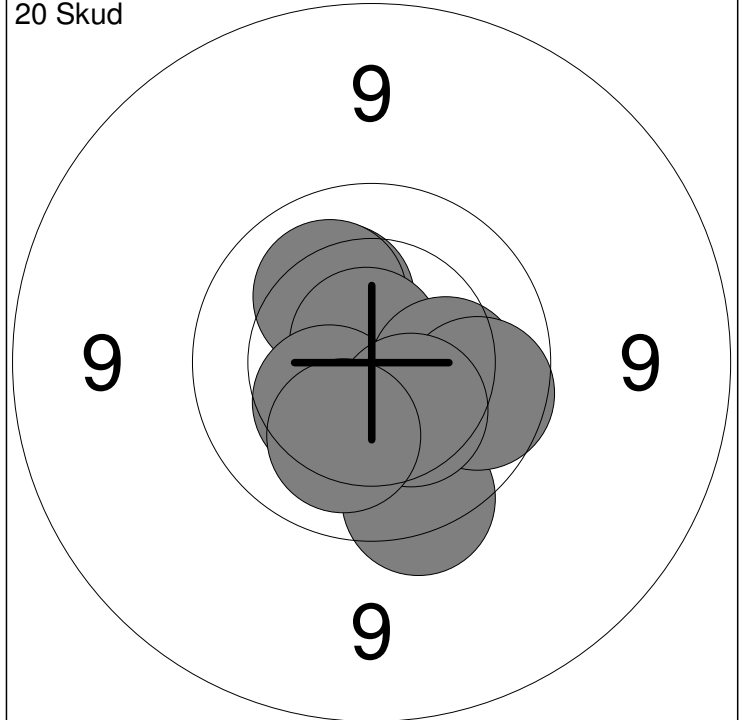
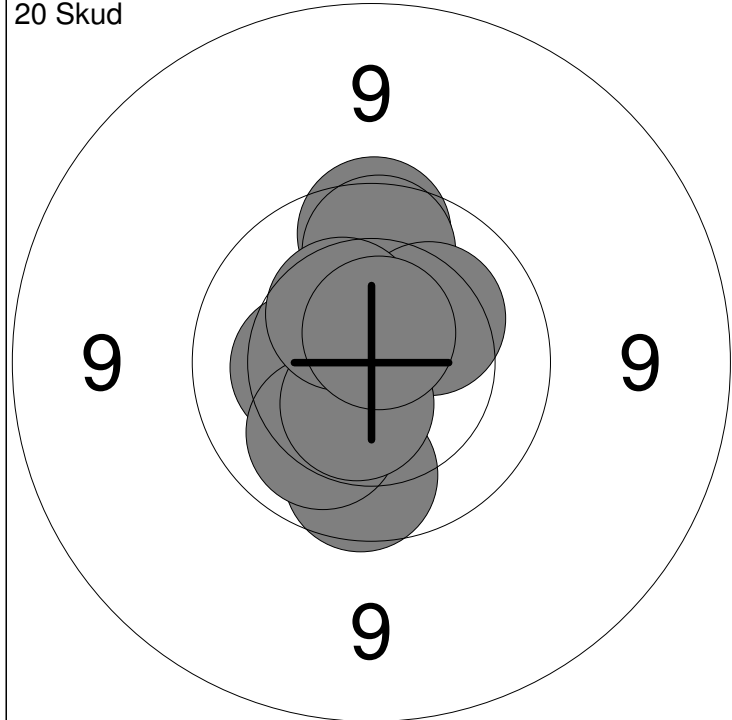

1: 9.8 ↑	6: 9.9 ↑	Serie	97
2: 10.3 ←	7: 10.2 ↗		
3: 9.9 ↓	8: 10.5x ↓	Total	97
4: 10.6x ↑	9: 10.4 ↖		
5: 10.1 ↘	10: 10.7x ↑		

11: 10.3 ↗	16: 10.2 →	Serie	98
12: 10.2 ↗	17: 9.9 →		
13: 10.3 ↓	18: 10.4 ↓	Total	195
14: 10.8x ↑	19: 10.3 ↓		
15: 9.7 ↓	20: 10.2 ↓		

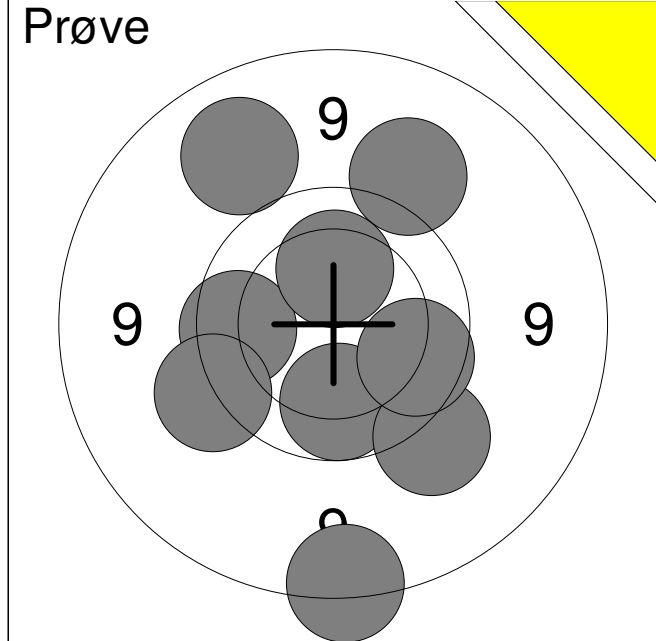

1:	10.0	↓
2:	9.8	←
3:	9.4	↘
4:	9.9	→
5:	8.7	↓
6:	9.3	↗
7:	9.5	←
8:	10.2	↑
9:	9.1	↖
<b>Serie</b>	<b>82.0</b>	
<b>Total</b>	<b>0.0</b>	

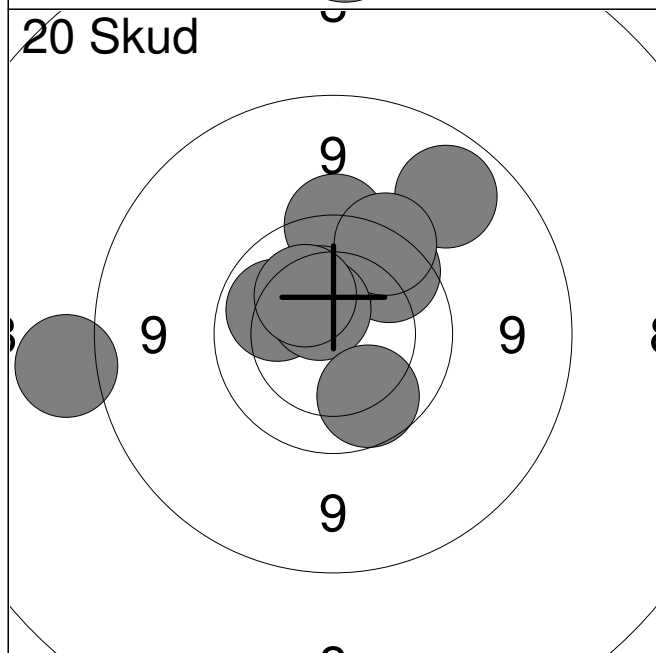

1:	10.1	←
2:	9.0	↗
3:	9.6	↑
4:	9.8	↗
5:	10.4	↑
6:	9.6	↗
7:	10.5x	↗
8:	8.5	←
9:	9.9	↘
10:	10.3	↗
<b>Serie</b>	<b>93.0</b>	
<b>Total</b>	<b>93.0</b>	

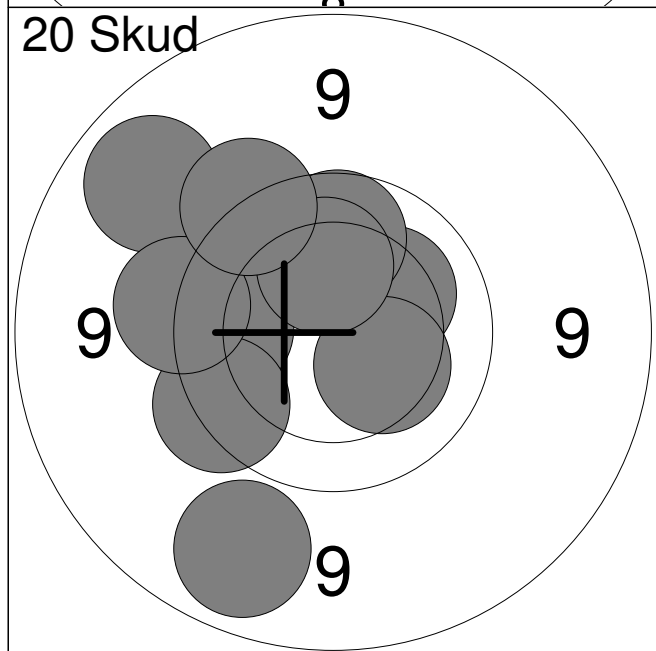

11:	10.2	↗
12:	10.3	↘
13:	9.8	←
14:	9.1	↗
15:	9.7	←
16:	9.6	←
17:	9.9	↑
18:	10.2	↑
19:	9.0	↘
20:	9.6	↖
<b>Serie</b>	<b>93.0</b>	
<b>Total</b>	<b>186.0</b>	



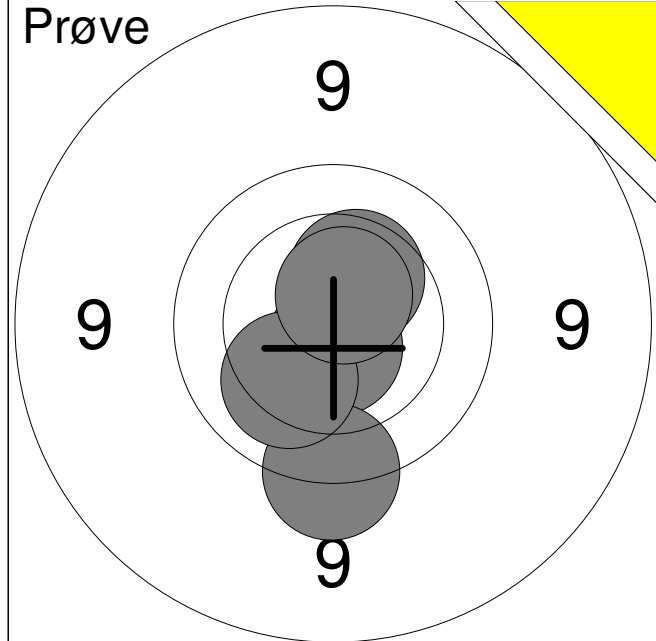

1:	10.7x	↓
2:	9.6	↓
3:	10.4	↗
4:	10.2	↙
5:	10.6x	↗
<b>Serie</b>		<b>49.0</b>
<b>Total</b>		<b>0.0</b>

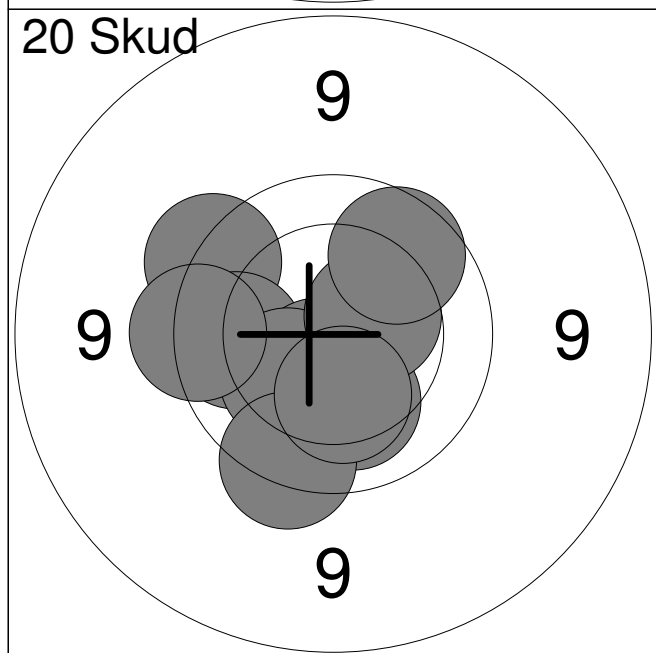

1:	9.6	↖
2:	9.9	←
3:	10.6x	↓
4:	10.3	↙
5:	10.2	↓
6:	10.5	↗
7:	9.7	←
8:	9.9	↗
9:	9.7	↓
10:	10.3	↓
<b>Serie</b>		<b>95.0</b>
<b>Total</b>		<b>95.0</b>

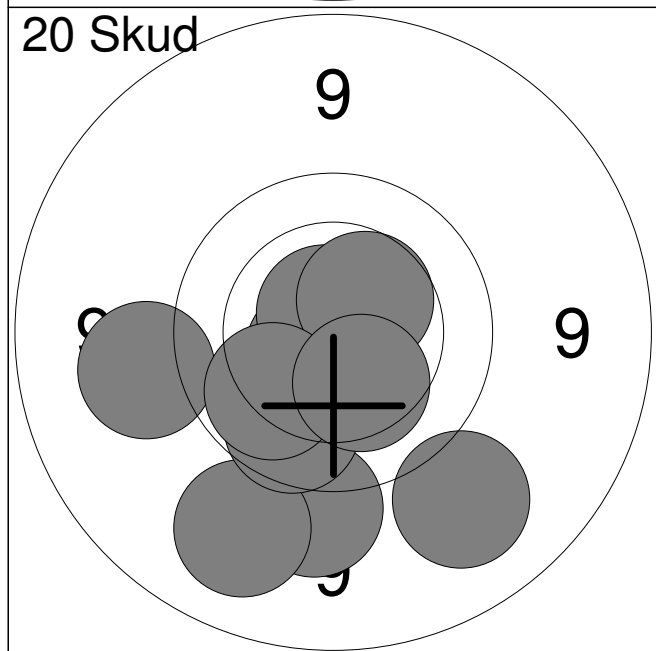

11:	10.6x	↙
12:	9.4	↓
13:	9.3	←
14:	10.7x	↗
15:	9.2	↓
16:	10.4	↗
17:	9.9	↓
18:	9.2	↙
19:	10.0	↙
20:	10.3	↓
<b>Serie</b>		<b>95.0</b>
<b>Total</b>		<b>190.0</b>

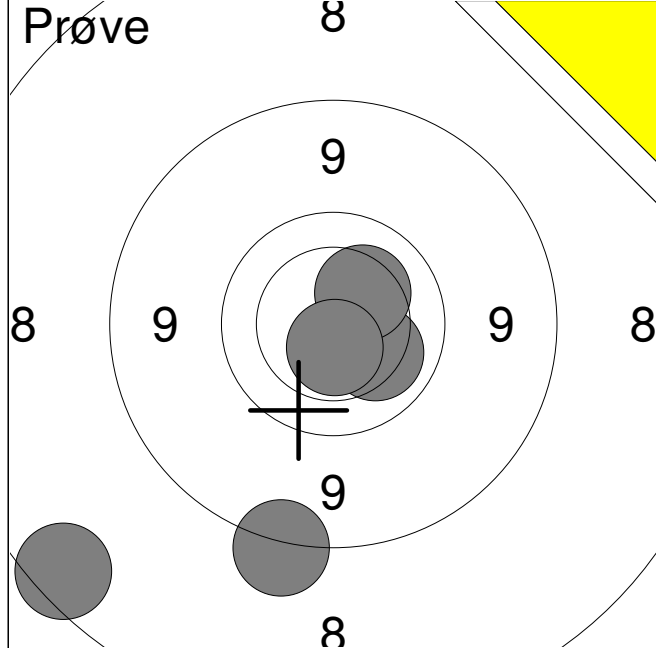

1:	7.8	↙
2:	8.6	↓
3:	10.1	↘
4:	10.3	↗
5:	10.6x	↓
<b>Serie</b>		<b>45.0</b>
<b>Total</b>		<b>0.0</b>

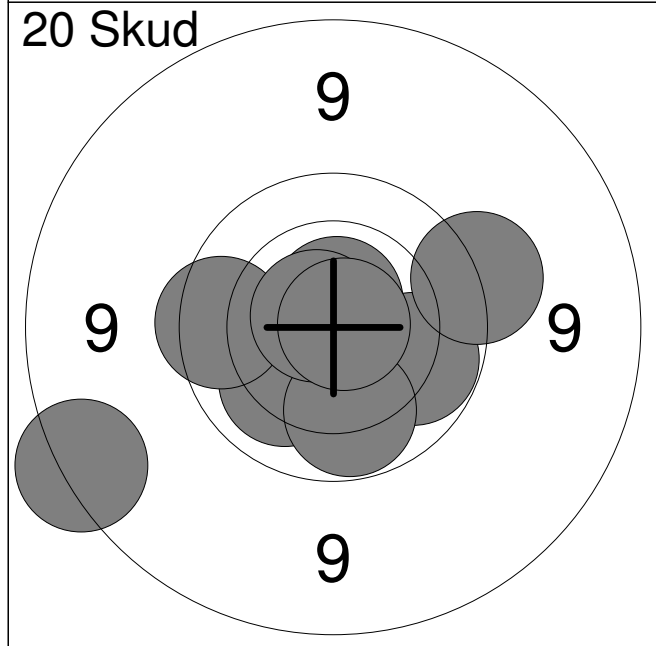

1:	10.6x	↘
2:	10.0	→
3:	10.7x	↑
4:	10.1	↙
5:	8.8	↖
6:	9.8	←
7:	10.0	↓
8:	10.7x	↖
9:	10.8x	→
10:	9.5	→
<b>Serie</b>		<b>96.0</b>
<b>Total</b>		<b>96.0</b>

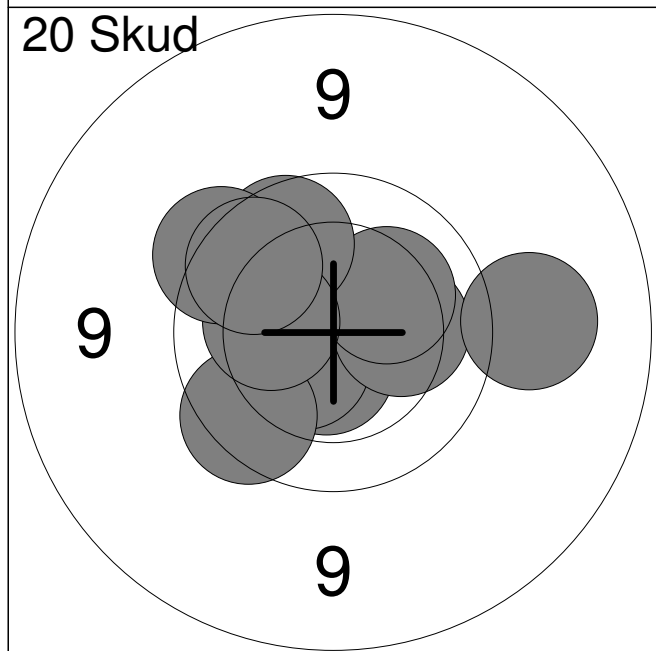

11:	10.6x	↓
12:	10.5	↙
13:	10.2	→
14:	10.2	↗
15:	9.9	↗
16:	9.8	↙
17:	10.3	←
18:	9.7	↖
19:	9.3	→
20:	9.9	↖
<b>Serie</b>		<b>95.0</b>
<b>Total</b>		<b>191.0</b>

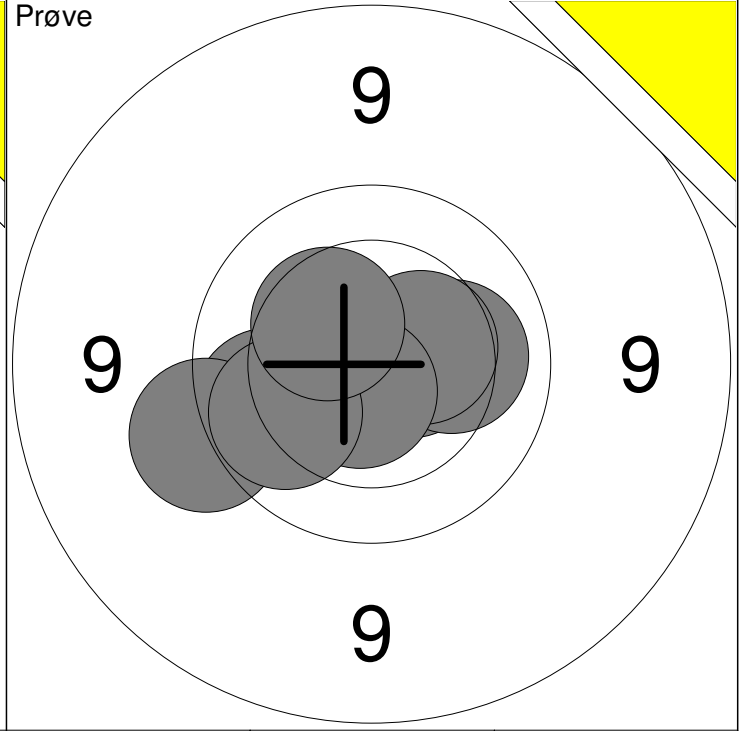
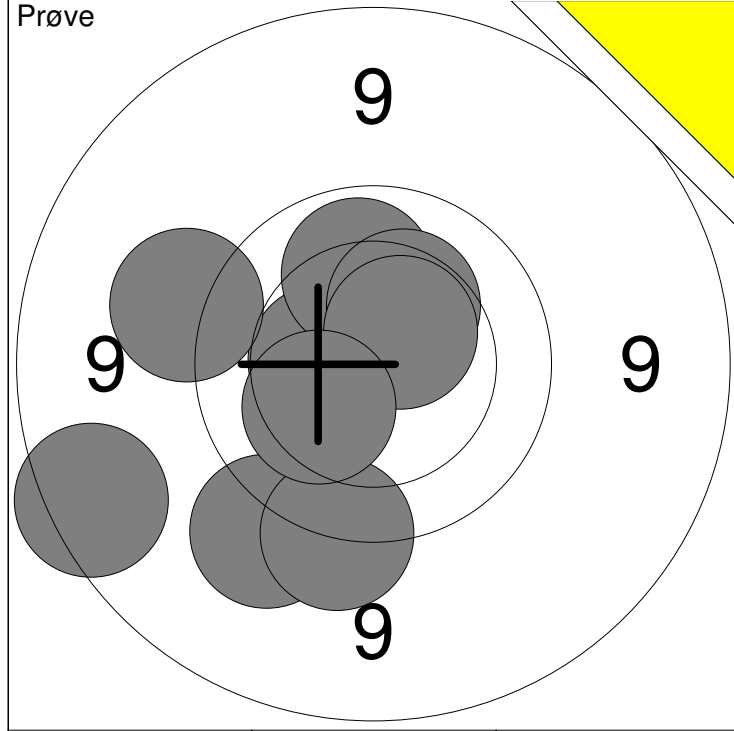

1: 9.4 ↙	6: 10.1 ↑	Serie	95
2: 8.8 ↙	7: 10.3 ↗		
3: 10.5 ←	8: 9.6 ↓	Total	0
4: 9.4 ↙	9: 10.5x ↗		
5: 10.3 ↗	10: 10.3 ↙		

11: 10.6x →	16: 10.7x ↓	Serie	78
12: 10.2 →	17: 10.0 ↙		
13: 9.9 ←	18: 10.4 ↙	Total	0
14: 9.5 ←			
15: 10.4 →			

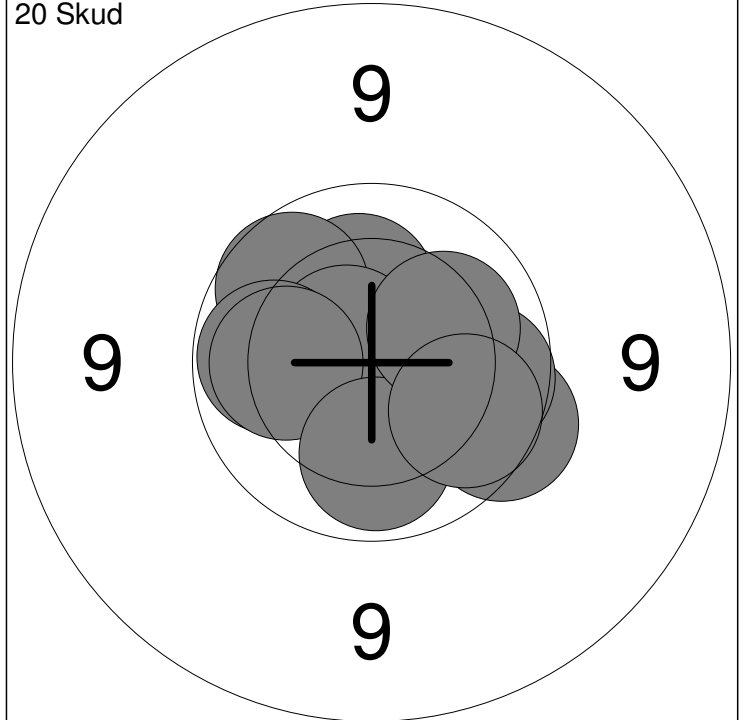
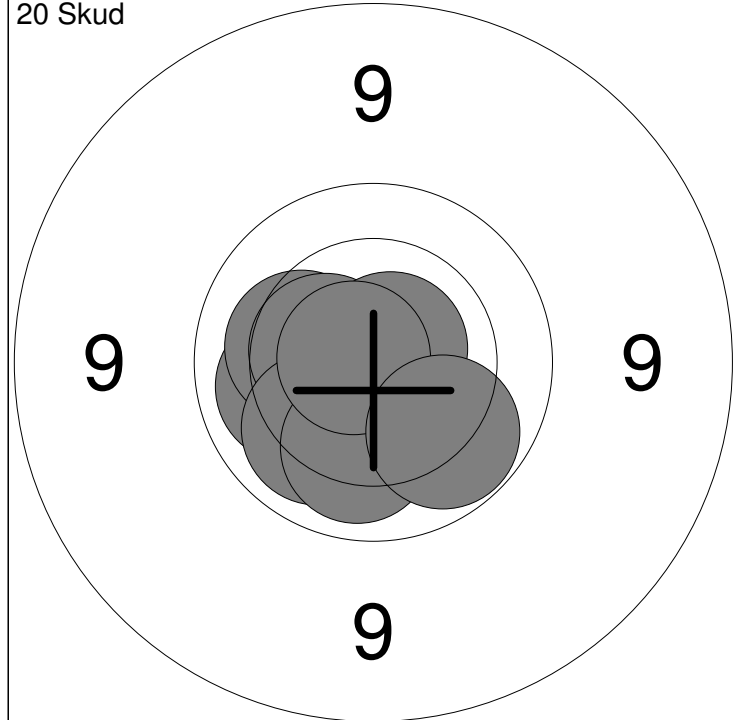

1: 10.4 ↓	6: 10.3 ↓	Serie	100
2: 10.1 ←	7: 10.7x ↗		
3: 10.2 ←	8: 10.1 ↓	Total	100
4: 10.5 ←	9: 10.8x ←		
5: 10.1 ↙	10: 10.0 ↓		

11: 9.7 →	16: 10.0 ←	Serie	96
12: 10.2 ↑	17: 10.1 ←		
13: 9.9 ↗	18: 10.1 ↓	Total	196
14: 10.6x ↗	19: 10.2 ↗		
15: 9.9 →	20: 9.9 ↘		

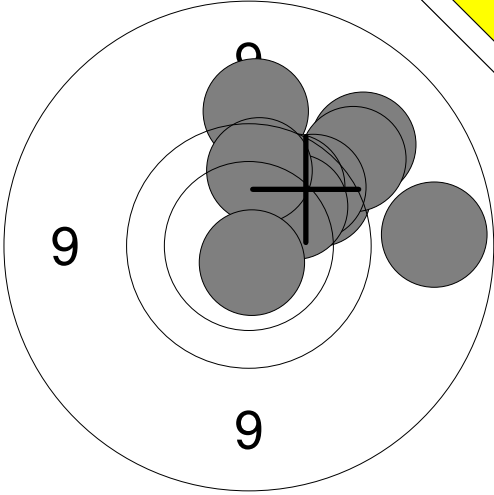
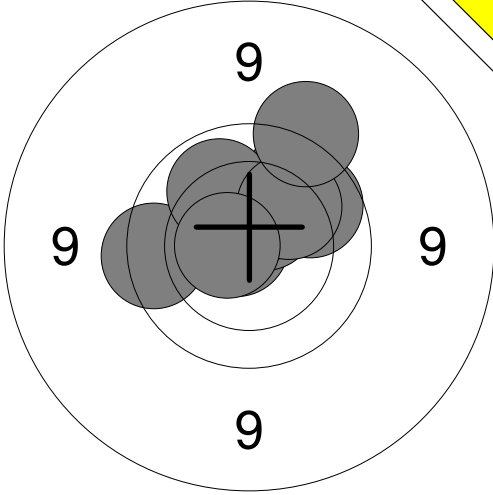
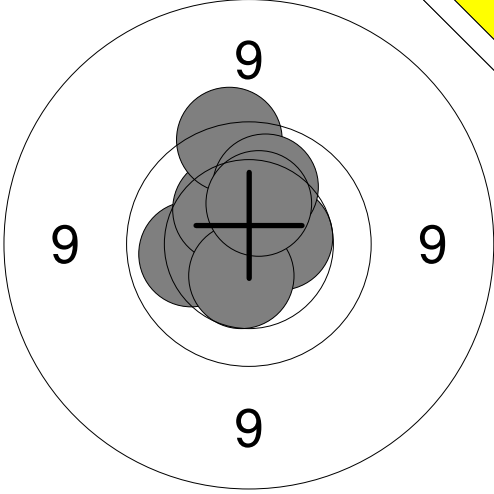
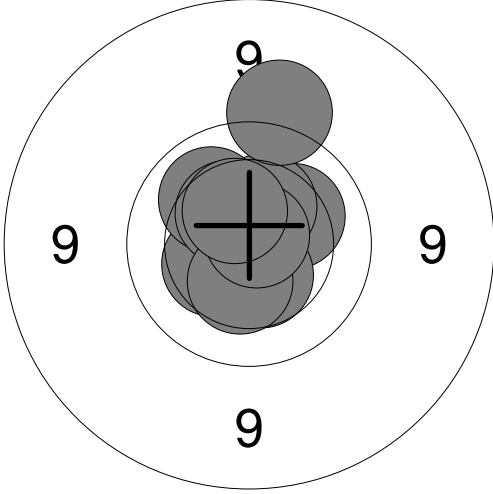
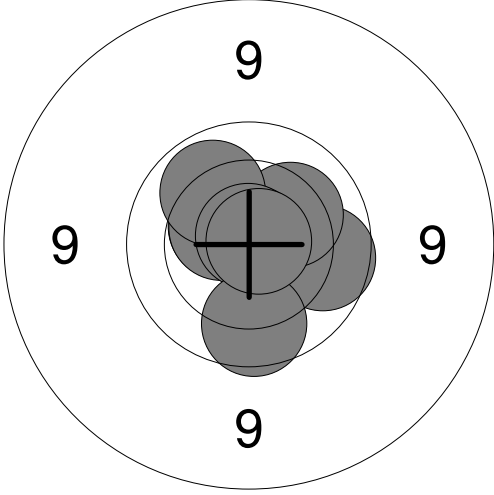
Hold	Skive	Luckas Heby Pedersen	
78	2		
AAS	Vadum Skf.	J2	
02.02.2017	NM 2017 ungdom riffel	Aalborg Skyttekreds	
Prøve		Prøve	
	1: 9.3 ↗ 2: 9.0 → 3: 9.4 ↑ 4: 9.8 ↗ 5: 9.4 ↗ 6: 9.8 ↗ 7: 9.9 ↗ 8: 10.1 ↗ 9: 9.9 ↑ 10: 10.7x↓		11: 9.7 ← 12: 10.8x↖ 13: 10.5x↗ 14: 10.6x↖ 15: 9.9 ↗ 16: 9.9 ↗ 17: 10.1 ↖ 18: 10.1 ↗ 19: 9.5 ↗ 20: 10.6x↖
	Serie 92.0		Serie 96.0
	Total 0.0		Total 0.0
Prøve		20 Skud	
	21: 10.1← 22: 10.5x➤ 23: 10.3 ↖ 24: 9.7 ↑ 25: 10.5 ↓ 26: 10.1 ↑ 27: 10.3 ↑		1: 10.2 ↗ 2: 10.5 ↓ 3: 10.4 ↑ 4: 10.4 ↖ 5: 10.1 ↖ 6: 10.4 ↖ 7: 10.4 ↓ 8: 9.4 ↑ 9: 10.8x↗ 10: 10.4 ↖
	Serie 69.0		Serie 99.0
	Total 0.0		Total 99.0
20 Skud			
	11: 9.9 → 12: 10.5 ↖ 13: 10.8x↗ 14: 10.5x↖ 15: 10.2 ↗ 16: 10.1 ↖ 17: 10.8x↗ 18: 10.8x↗ 19: 9.9 ↓ 20: 10.8x➤		
	Serie 98.0		
	Total 197.0		

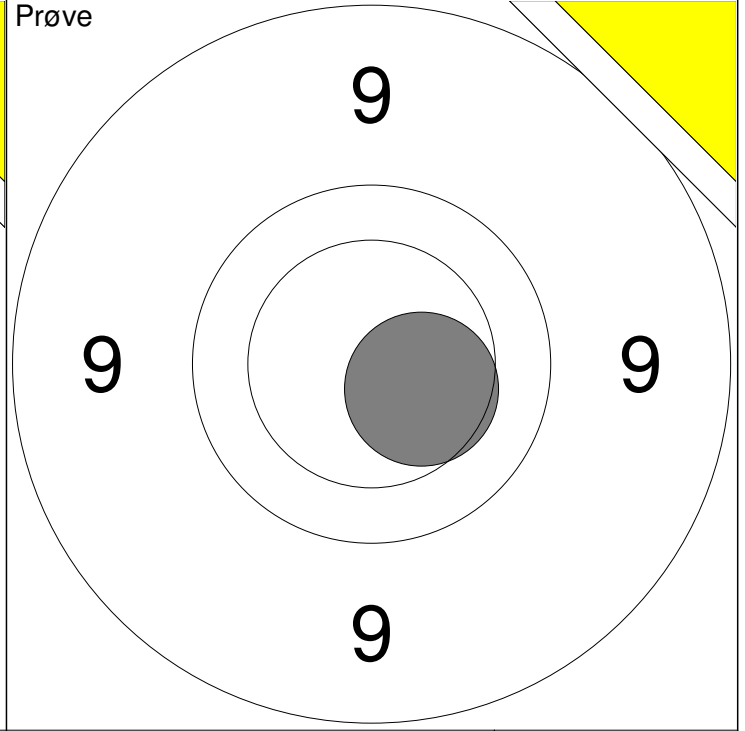
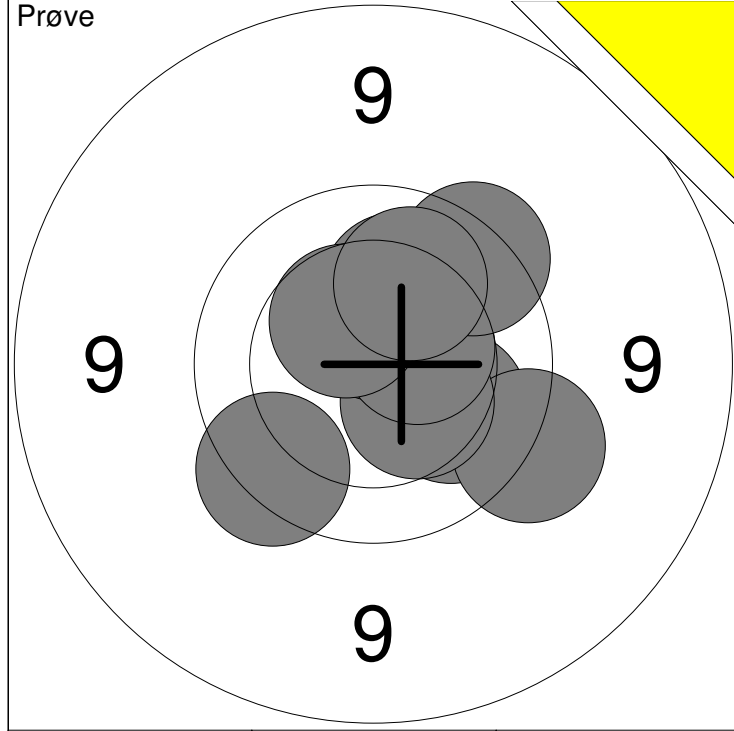

1: 10.2 ↗	6: 10.6x ↗	Serie 97
2: 10.1 ↘	7: 10.5 →	
3: 9.5 ↘	8: 9.7 ↗	Total 0
4: 9.7 ↙	9: 10.4 ↗	
5: 10.4 ↘	10: 10.1 ↗	

12: 10.4 ↘	Serie 10
	Total 0

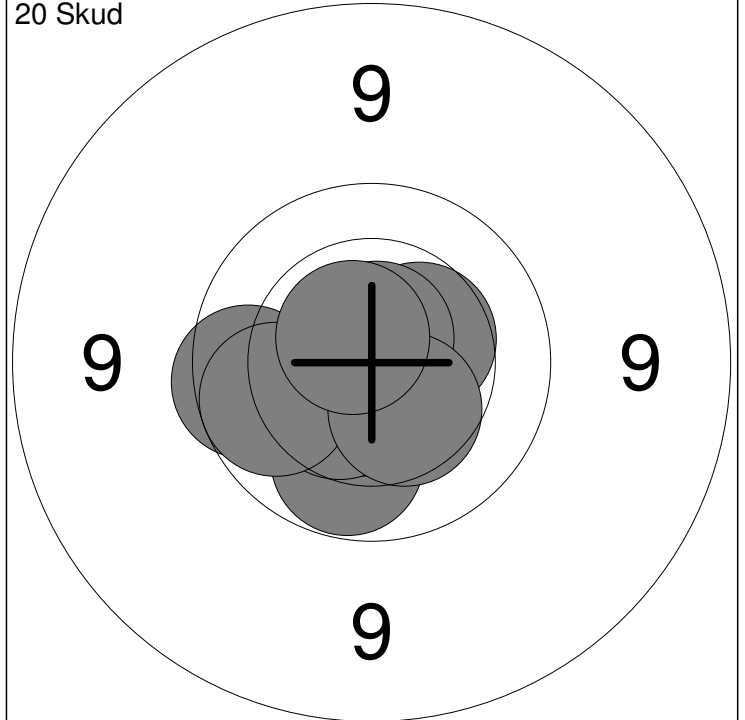
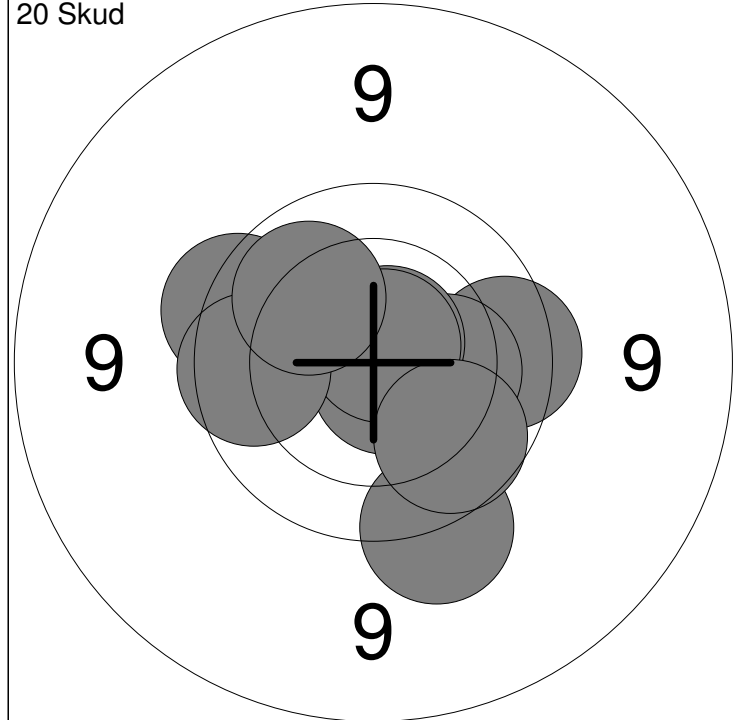

1: 9.8 →	6: 10.7x ↗	Serie 95
2: 10.2 →	7: 10.8x ↗	
3: 9.5 ↘	8: 9.9 ↘	Total 95
4: 10.7x ↘	9: 9.9 ←	
5: 9.7 ←	10: 10.1 ↗	

11: 10.0 ↘	16: 10.0 ←	Serie 99
12: 9.8 ←	17: 10.4 →	
13: 10.6x ↘	18: 10.7x ↗	Total 194
14: 10.5 ↙	19: 10.4 ↘	
15: 10.9x →	20: 10.6x ↗	

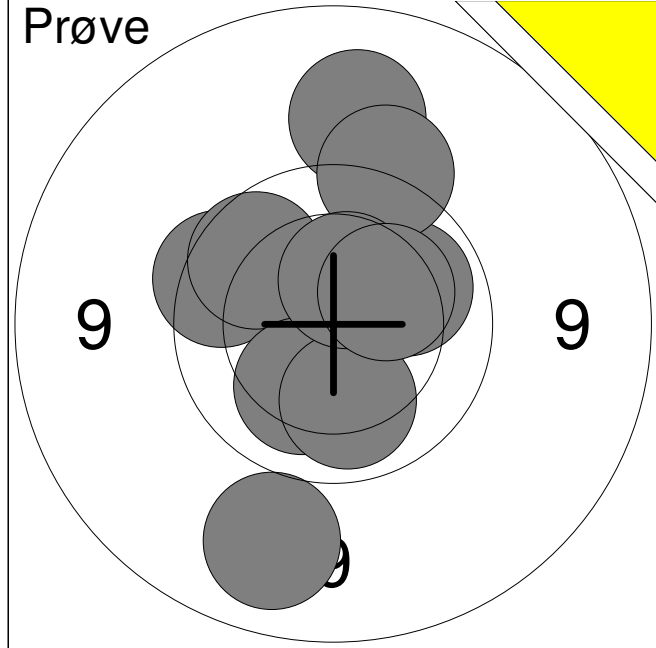

1:	9.1	↓
2:	9.2	↑
3:	10.1	↗
4:	9.5	↑
5:	9.8	←
6:	9.9	↖
7:	10.2	↓
8:	10.1	↓
9:	10.4	↑
10:	10.3	↗
<b>Serie</b>		<b>95.0</b>
<b>Total</b>		<b>0.0</b>

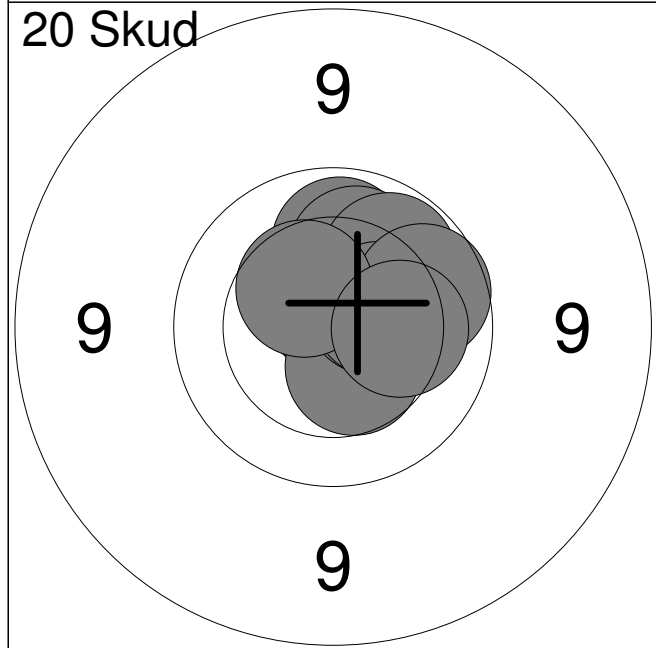

1:	10.0	↑
2:	10.1	↑
3:	10.7x	↑
4:	10.5	↓
5:	10.5	↗
6:	10.0	↗
7:	10.4	↗
8:	9.9	↗
9:	10.4	↖
10:	10.2	→
<b>Serie</b>		<b>99.0</b>
<b>Total</b>		<b>99.0</b>

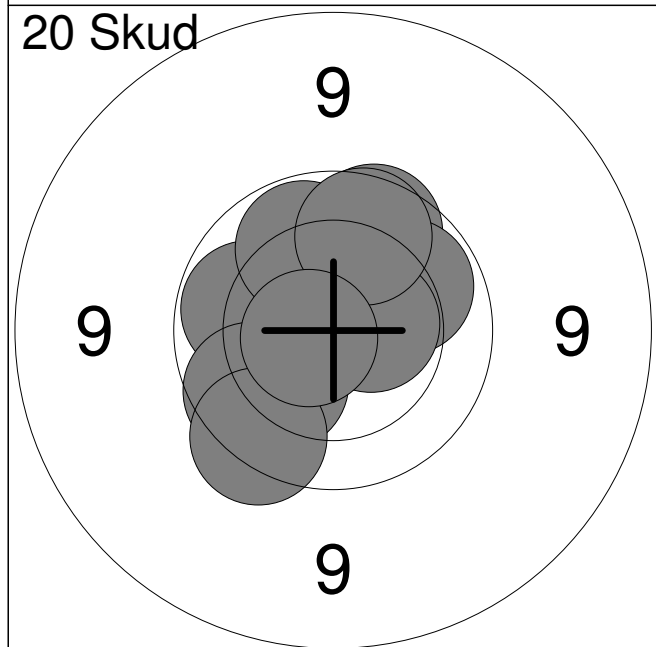

11:	10.0	←
12:	10.1	↖
13:	9.9	↖
14:	9.7	↓
15:	10.0	↑
16:	9.9	↑
17:	10.0	↗
18:	10.5x	→
19:	9.9	↑
20:	10.7x	←
<b>Serie</b>		<b>96.0</b>
<b>Total</b>		<b>195.0</b>

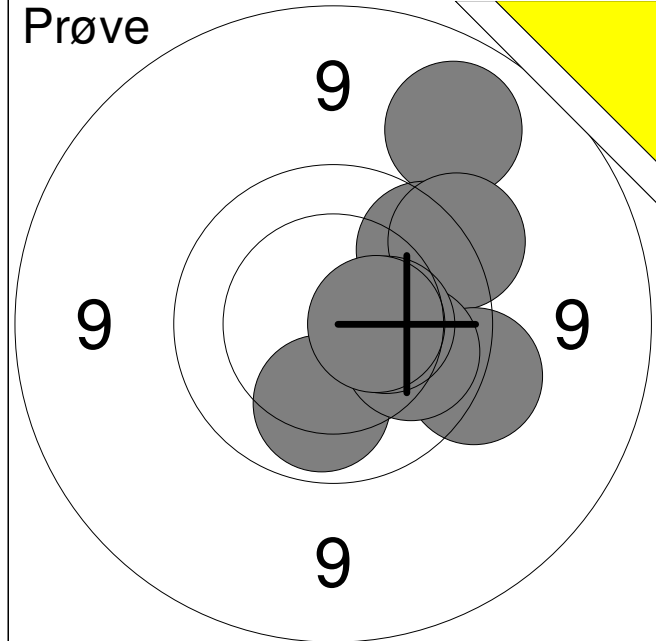

1:	9.1	↗
2:	9.8	↗
3:	9.6	↗
4:	10.3	→
5:	10.1	↓
6:	9.6	→
7:	10.0	→
8:	10.4	→
9:	10.5	→
<b>Serie</b>		<b>86.0</b>
<b>Total</b>		<b>0.0</b>

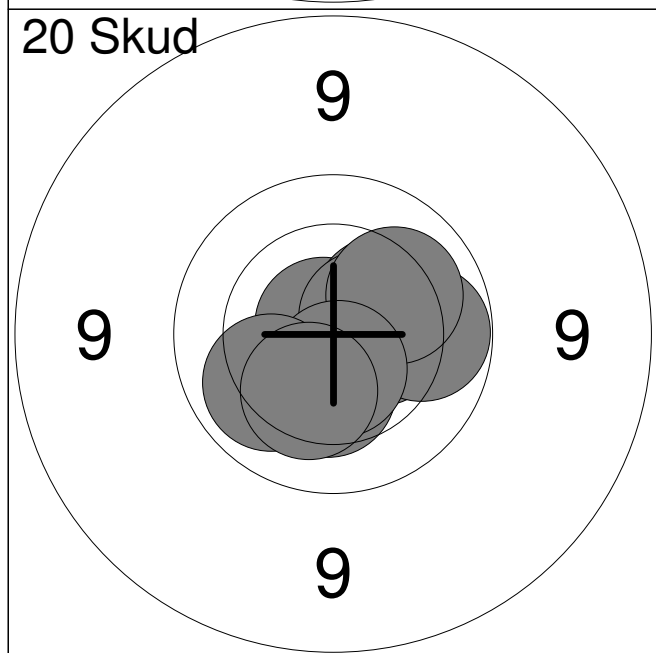

1:	10.5	→
2:	10.8x	↗
3:	10.3	↗
4:	10.5x	↗
5:	10.0	→
6:	10.3	↓
7:	10.2	↗
8:	10.6x	↓
9:	10.1	↙
10:	10.3	↓
<b>Serie</b>		<b>100.0</b>
<b>Total</b>		<b>100.0</b>

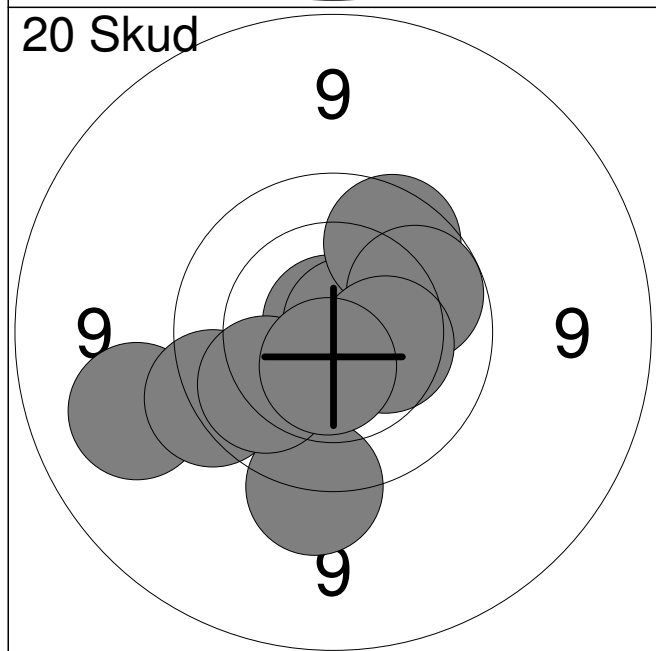

11:	9.5	↓
12:	10.8x	↑
13:	10.7x	↗
14:	9.2	↙
15:	9.8	↗
16:	9.7	↙
17:	10.0	↗
18:	10.4	→
19:	10.0	↙
20:	10.6x	↓
<b>Serie</b>		<b>96.0</b>
<b>Total</b>		<b>196.0</b>

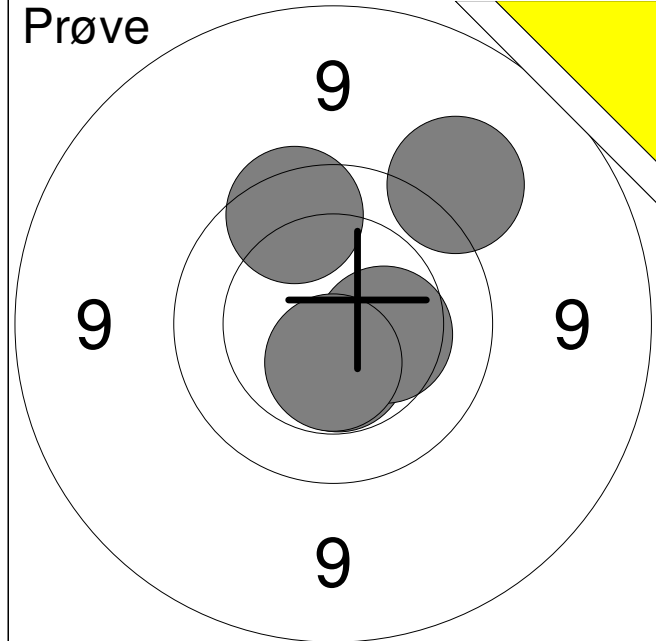

1:	9.4	↗
2:	9.8	↑
3:	10.5x	↓
4:	10.4	→
5:	10.5x	↓
<b>Serie</b>		<b>48.0</b>
<b>Total</b>		<b>0.0</b>

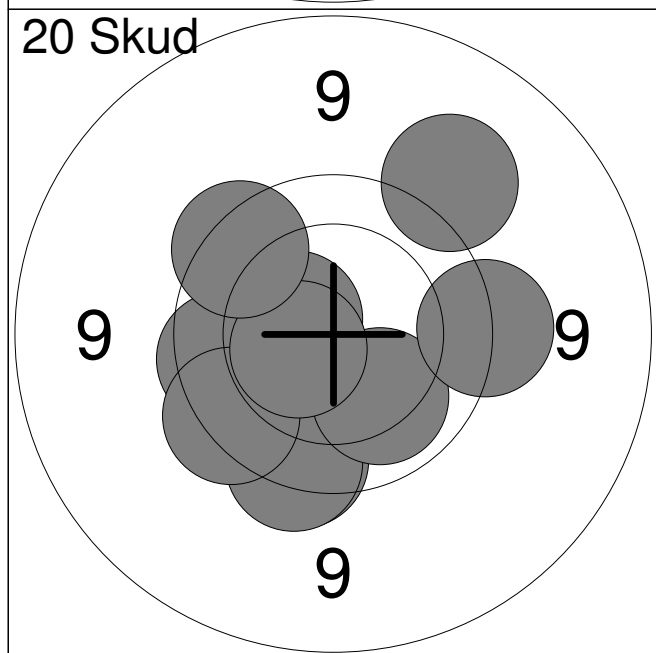

1:	9.3	↗
2:	10.5	↖
3:	9.8	↖
4:	9.7	↓
5:	9.7	↓
6:	10.1	↓
7:	9.7	↖
8:	9.6	→
9:	10.5x	↖
10:	9.7	↗
<b>Serie</b>		<b>93.0</b>
<b>Total</b>		<b>93.0</b>

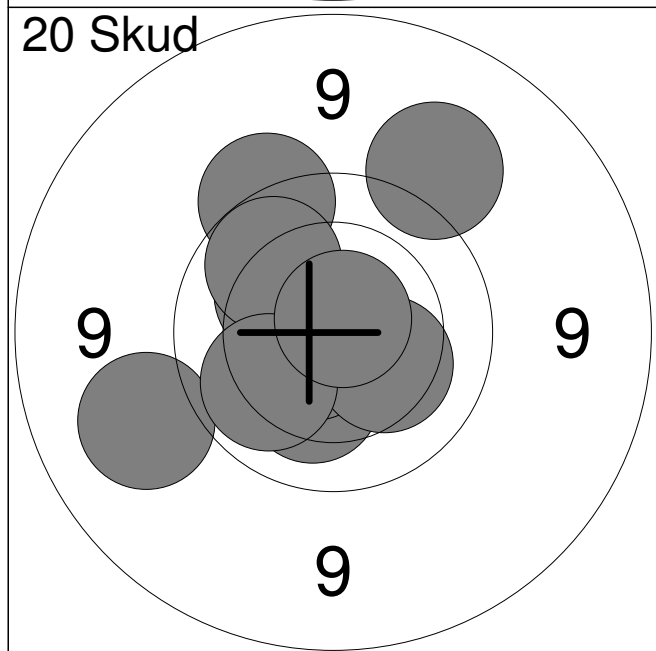

11:	10.2	↗
12:	10.2	↓
13:	9.2	↖
14:	10.6x	↖
15:	9.6	↑
16:	10.0	↗
17:	10.3	↘
18:	9.3	↗
19:	10.1	↖
20:	10.8x	↗
<b>Serie</b>		<b>97.0</b>
<b>Total</b>		<b>190.0</b>

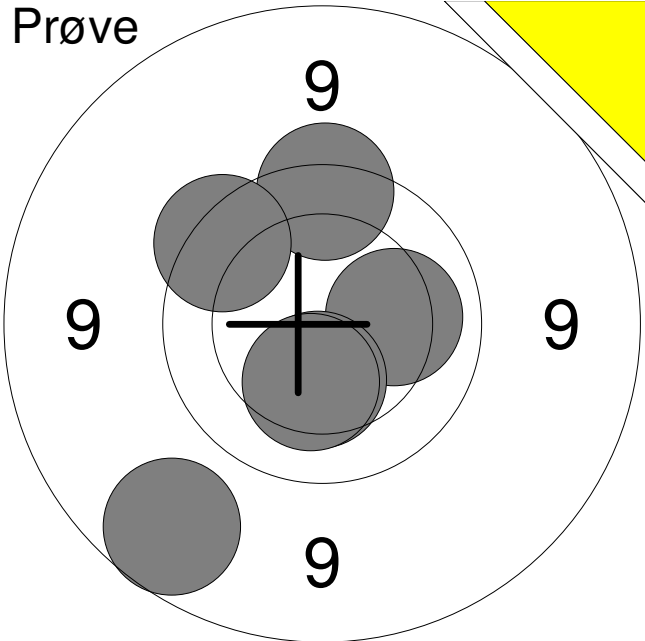
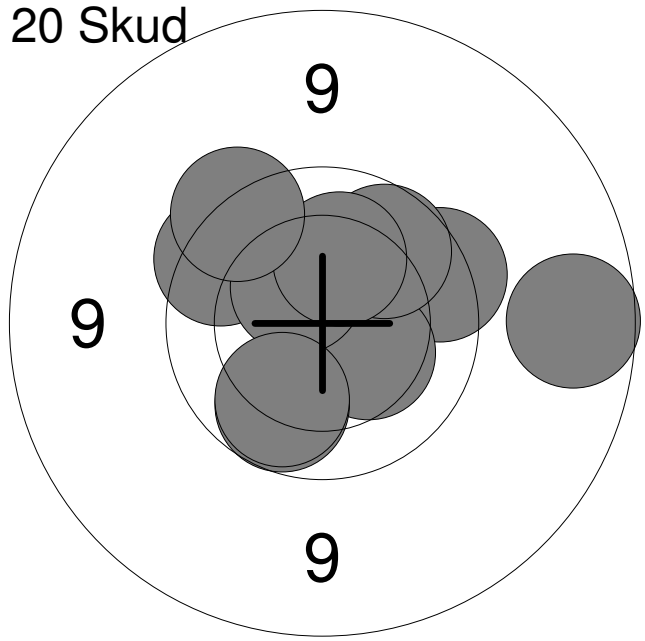
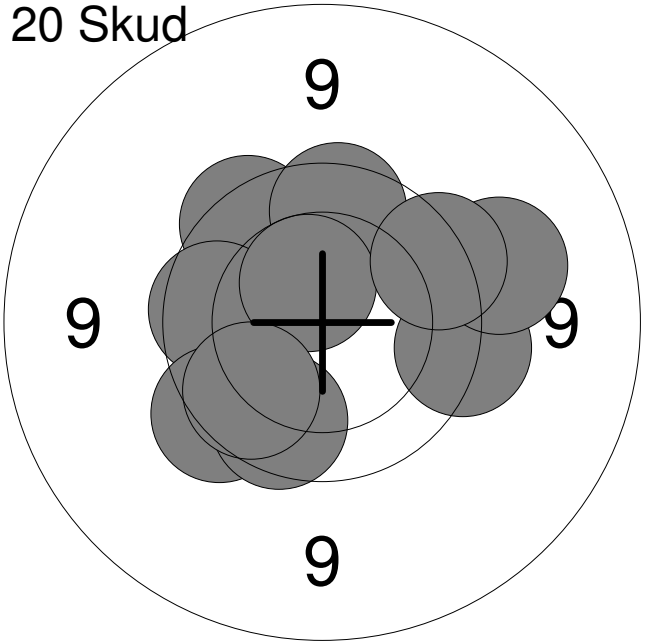

Hold <b>78</b>	Skive <b>8</b>	<b>Nicklas W. Pedersen</b>		
AAS		Hjørring Skytteforening		MB3
02.02.2017		NM 2017 ungdom riffel		Aalborg Skyttekreds
<b>Prøve</b>				
		1:	8.9	↙
		2:	10.2	→
		3:	10.3	↓
		4:	9.7	↑
		5:	9.7	↗
		6:	10.3	↓
		<b>Serie</b>		<b>56.0</b>
		<b>Total</b>		<b>0.0</b>
<b>20 Skud</b>				
		1:	9.8	↖
		2:	9.7	→
		3:	8.9	→
		4:	10.3	↘
		5:	10.5	↗
		6:	9.9	↗
		7:	10.2	↑
		8:	9.6	↗
		9:	9.9	↓
		10:	10.0	↓
		<b>Serie</b>		<b>93.0</b>
		<b>Total</b>		<b>93.0</b>
<b>20 Skud</b>				
		11:	9.7	↖
		12:	9.6	→
		13:	9.9	←
		14:	9.7	↘
		15:	9.8	↓
		16:	9.8	↑
		17:	10.5	↑
		18:	9.4	→
		19:	9.9	↘
		20:	9.7	↗
		<b>Serie</b>		<b>91.0</b>
		<b>Total</b>		<b>184.0</b>

<b>Prøve</b> 	1:	10.7x	←
	2:	10.3	↖
	3:	10.6x	←
	4:	10.0	↘
	5:	10.4	→
	6:	10.5	↗
<b>Serie</b>		<b>60.0</b>	
<b>Total</b>		<b>0.0</b>	

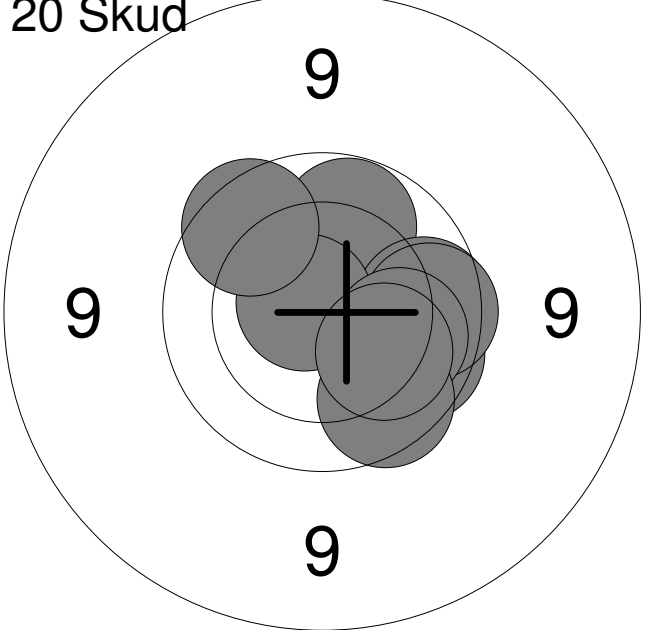
<b>20 Skud</b> 	1:	10.6x	↑
	2:	9.9	↘
	3:	10.0	↑
	4:	9.9	→
	5:	10.7x	↖
	6:	9.8	→
	7:	10.1	↘
	8:	9.8	↘
	9:	9.8	↗
	10:	10.1	↘
<b>Serie</b>		<b>95.0</b>	
<b>Total</b>		<b>95.0</b>	

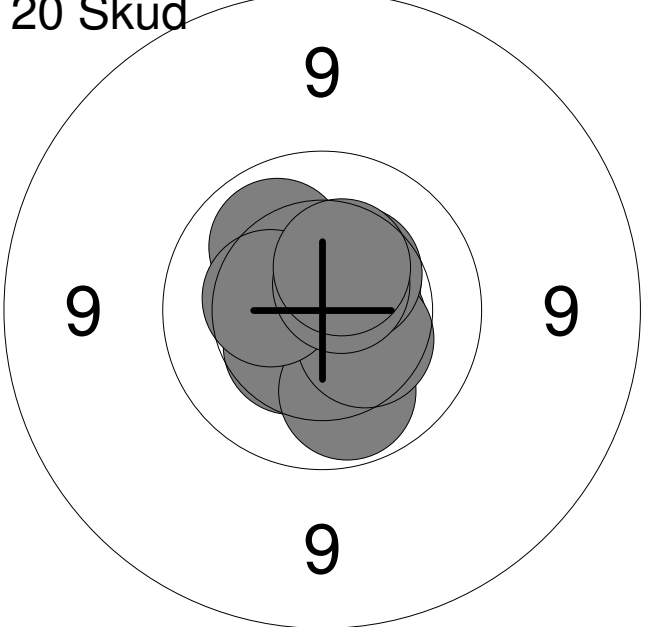
<b>20 Skud</b> 	11:	10.4	↘
	12:	10.5	↗
	13:	10.5x	↘
	14:	10.1	↗
	15:	10.0	↘
	16:	10.4	↘
	17:	10.4	←
	18:	10.4	↗
	19:	10.6x	↗
	20:	10.4	↗
<b>Serie</b>		<b>100.0</b>	
<b>Total</b>		<b>195.0</b>	

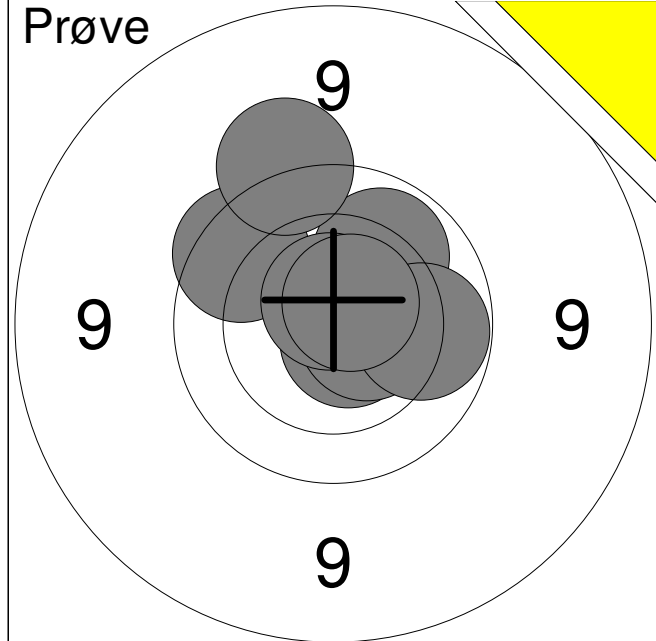

1:	10.7x	↘
2:	10.0	↗
3:	10.6x	→
4:	10.0	→
5:	9.8	↗
6:	9.5	↗
7:	10.7x	↗
8:	10.6x	↗
<b>Serie</b>		<b>78.0</b>
<b>Total</b>		<b>0.0</b>

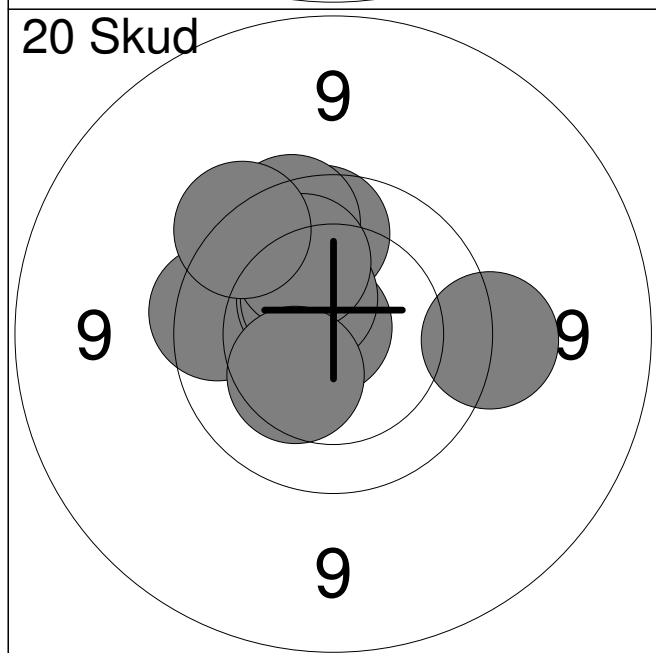

1:	9.8	←
2:	10.8x	↗
3:	10.5	↗
4:	9.9	↗
5:	10.5	↗
6:	9.8	↗
7:	10.1	↗
8:	10.3	↘
9:	9.7	↗
10:	9.5	→
<b>Serie</b>		<b>95.0</b>
<b>Total</b>		<b>95.0</b>

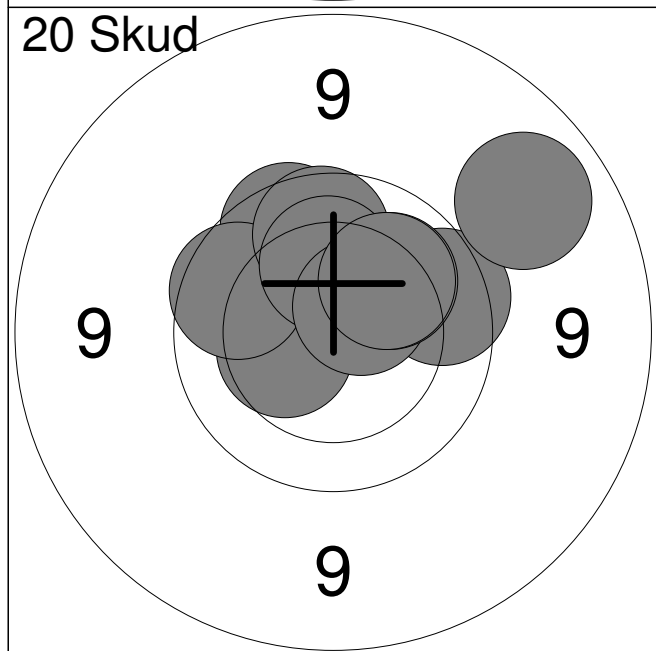

11:	9.8	↗
12:	9.8	→
13:	9.1	↗
14:	10.4	←
15:	9.9	←
16:	9.9	↗
17:	10.2	↗
18:	10.5x	↗
19:	10.1	↗
20:	10.1	↗
<b>Serie</b>		<b>95.0</b>
<b>Total</b>		<b>190.0</b>

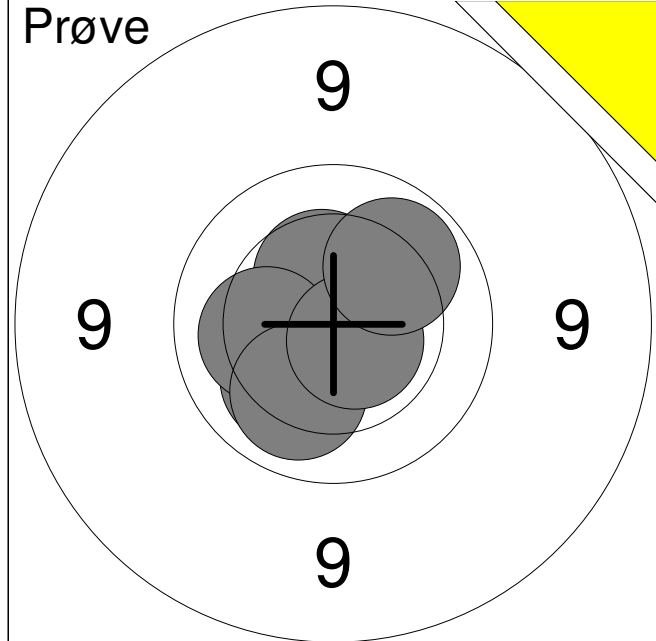

1:	10.6x	←
2:	10.4	↑
3:	10.2	↘
4:	10.2	←
5:	10.1	↘
6:	10.6x	↘
7:	10.0	↗
<b>Serie</b>		<b>70.0</b>
<b>Total</b>		<b>0.0</b>

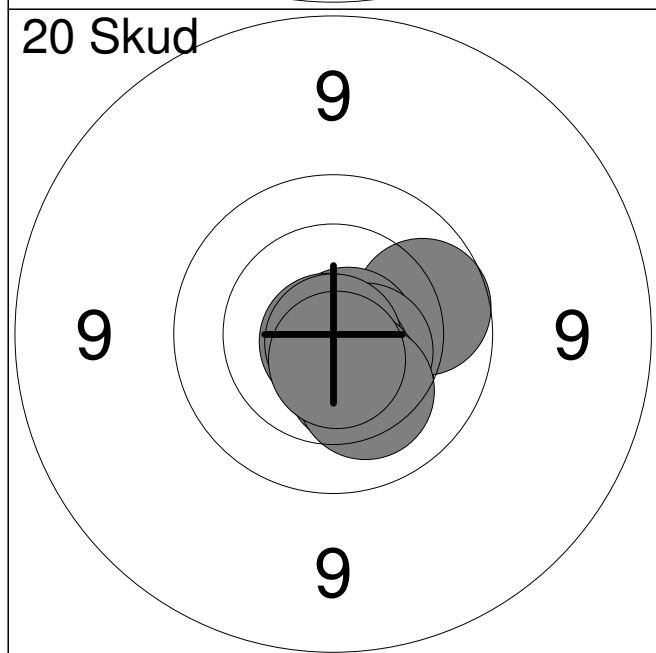

1:	10.4	↘
2:	9.9	→
3:	10.8x	→
4:	10.8x	↘
5:	10.6x	↘
6:	10.6x	↘
7:	10.9x	↘
8:	10.4	↘
9:	10.2	↘
10:	10.7x	↘
<b>Serie</b>		<b>99.0</b>
<b>Total</b>		<b>99.0</b>

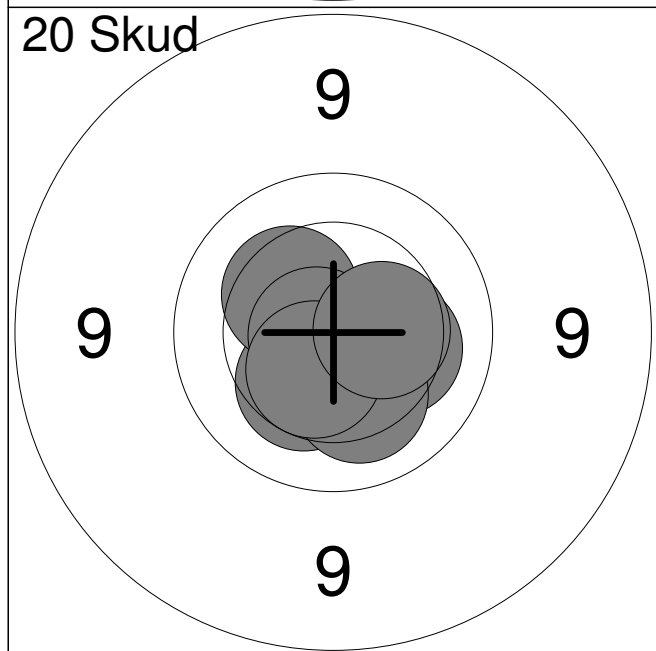

11:	10.6x	→
12:	10.9x	↘
13:	10.3	→
14:	10.3	→
15:	10.3	↘
16:	10.3	↗
17:	10.8x	←
18:	10.2	↘
19:	10.5	↘
20:	10.4	→
<b>Serie</b>		<b>100.0</b>
<b>Total</b>		<b>199.0</b>

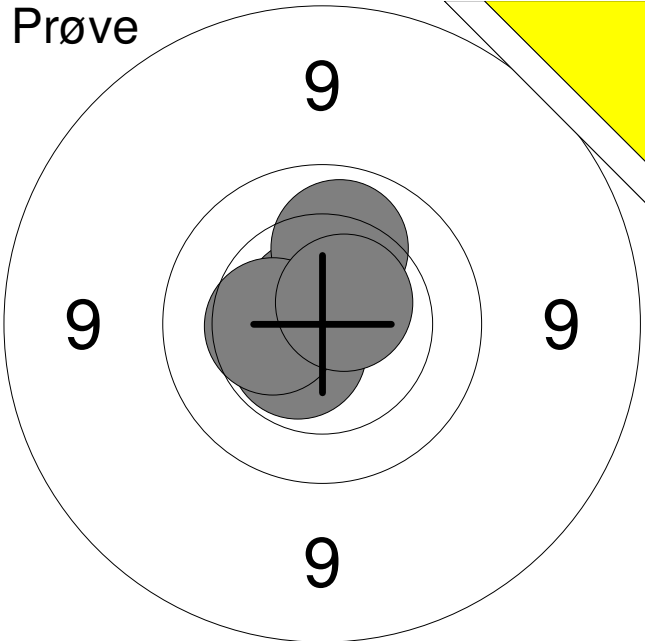
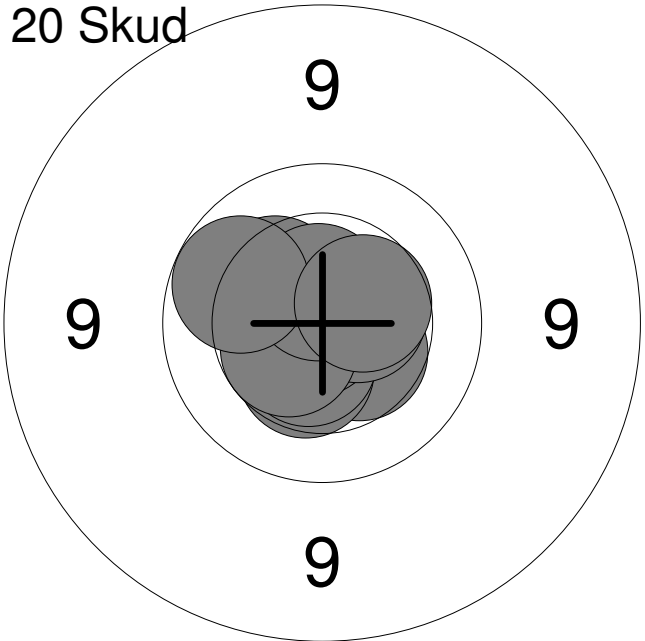
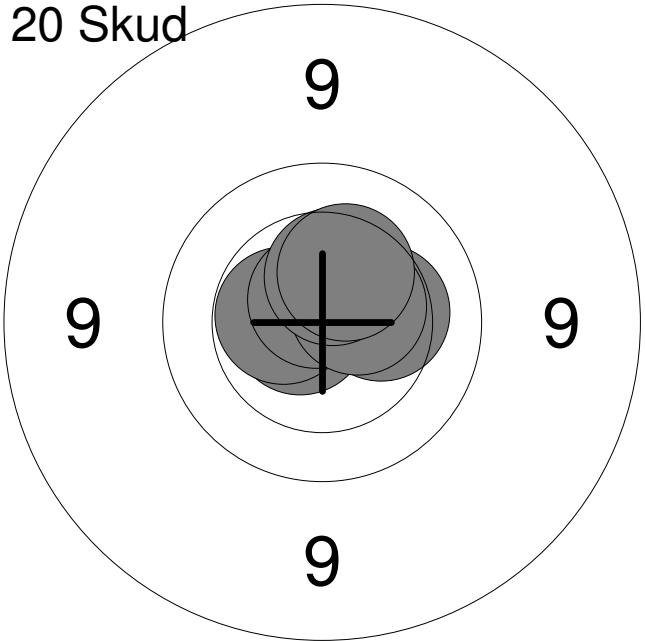
Hold	Skive	Lars Padfield	
78	12	Lars Padfield	
AAS		Hjørring Skytteforening	MJ2
02.02.2017	NM 2017 ungdom riffel		Aalborg Skyttekreds
Prøve		1: 10.7x ↗	
		2: 10.6x ↘	
		3: 10.1 ↑	
		4: 10.4 ←	
		5: 10.6x ↗	
		Serie 50.0	
		Total 0.0	
20 Skud		1: 10.4 ↘	
		2: 10.4 ↓	
		3: 10.3 ↖	
		4: 10.5x ↓	
		5: 10.8x ↙	
		6: 10.5x →	
		7: 10.5 ↙	
		8: 10.6x ↑	
		9: 10.0 ↖	
		10: 10.5 ↗	
		Serie 100.0	
		Total 100.0	
20 Skud		11: 10.7x ↗	
		12: 10.7x ←	
		13: 10.5x ↑	
		14: 10.3 →	
		15: 10.5x ↙	
		16: 10.5x ↗	
		17: 10.7x ↑	
		18: 10.5x ↗	
		19: 10.4 ↑	
		20: 10.3 ↗	
		Serie 100.0	
		Total 200.0	

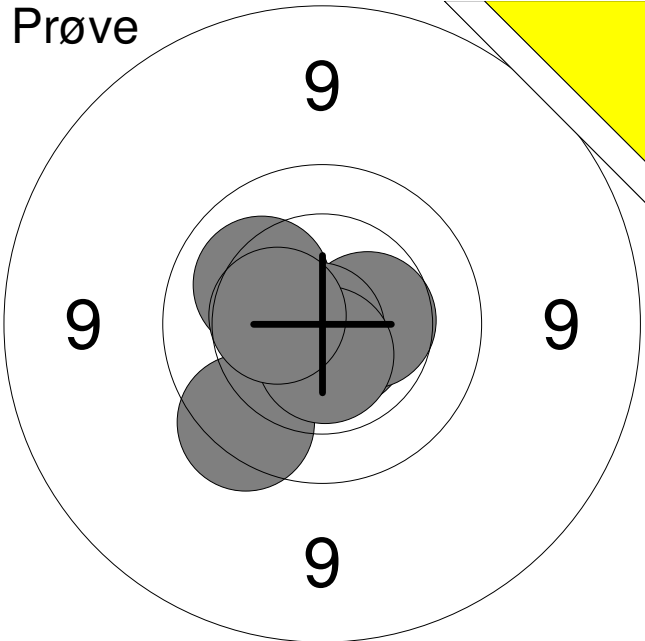
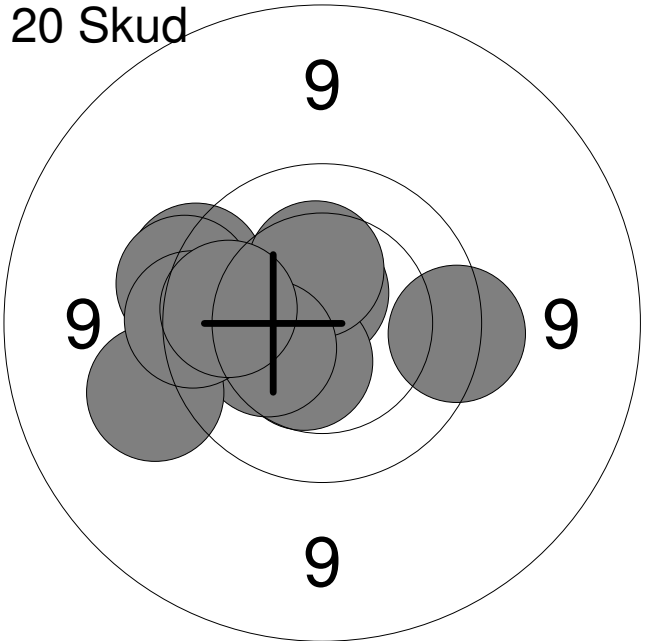
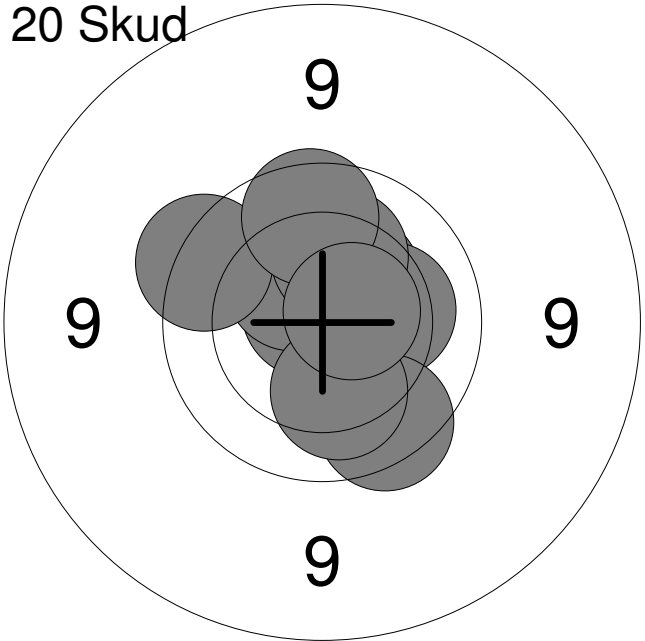
Hold	Skive	Magnus Neist	
79	1	Frederikshavn Skyttekreds	MB2
02.02.2017	NM 2017 ungdom riffel	Aalborg Skyttekreds	
Prøve		1: 10.7x	↘
		2: 9.7	↙
		3: 10.4	→
		4: 10.2	↗
		5: 10.9x	↙
		6: 10.6x	↓
		7: 10.4	←
		Serie	69.0
		Total	0.0
20 Skud		1: 9.7	↖
		2: 10.6x	↑
		3: 9.6	↖
		4: 10.5	↙
		5: 9.7	→
		6: 10.4	↑
		7: 10.3	↖
		8: 9.4	↖
		9: 9.7	↖
		10: 9.9	↖
		Serie	94.0
		Total	94.0
20 Skud		11: 10.8x	↗
		12: 10.4	↗
		13: 10.2	→
		14: 9.8	↙
		15: 10.4	↗
		16: 10.2	↙
		17: 9.7	↖
		18: 10.2	↑
		19: 9.9	↑
		20: 10.6x	↗
		Serie	97.0
		Total	191.0

Hold	Skive	Malthé Burholt	
79	2		
AAS		Frederikshavn Skyttekreds	MB2
02.02.2017	NM 2017 ungdom riffel	Aalborg Skyttekreds	
Prøve		1: 9.6	→
		2: 9.5	→
		3: 10.3	↗
		4: 10.0	→
		5: 10.1	↗
		6: 10.5	↗
		7: 10.5	↑
		Serie	68.0
		Total	0.0
20 Skud		1: 10.3	↑
		2: 10.7x	↗
		3: 10.5x	↑
		4: 10.5	→
		5: 10.0	↓
		6: 10.6x	↓
		7: 10.3	→
		8: 10.4	↘
		9: 10.3	↘
		10: 10.7x	↗
		Serie	100.0
		Total	100.0
20 Skud		11: 10.4	↙
		12: 10.6x	→
		13: 10.7x	↑
		14: 10.4	↙
		15: 10.0	↘
		16: 9.9	↖
		17: 10.2	↗
		18: 10.3	↑
		19: 10.8x	↘
		20: 10.4	↙
		Serie	99.0
		Total	199.0

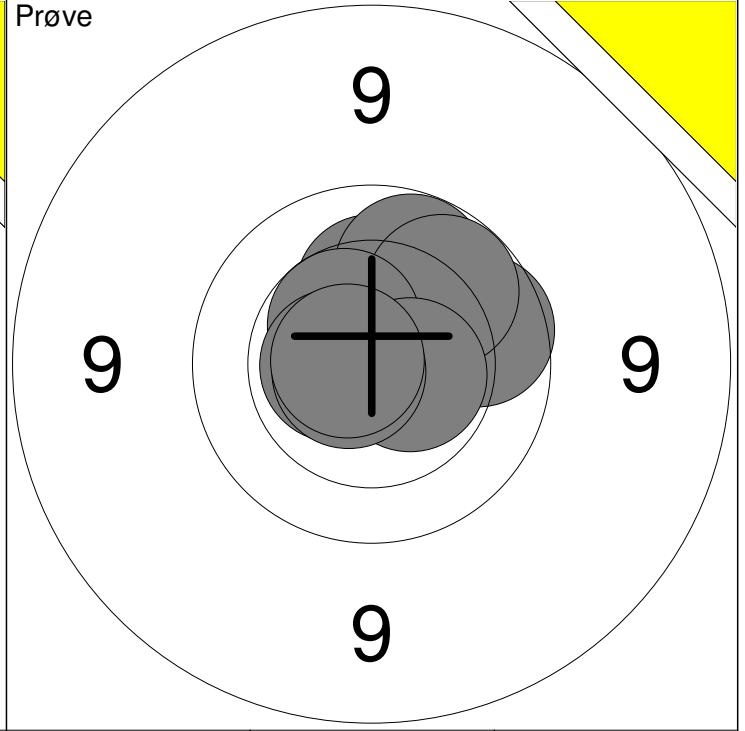
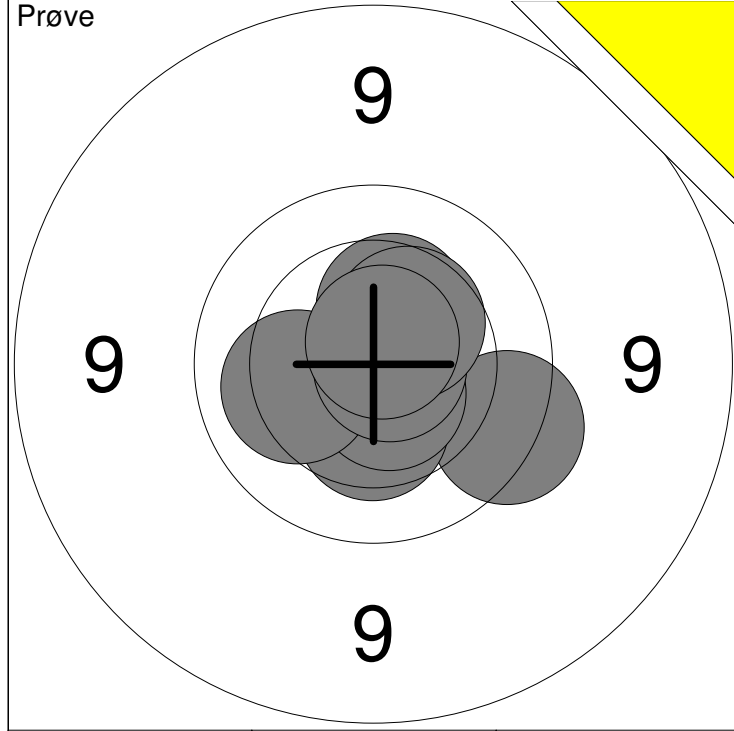

1: 9.7 ↘	6: 10.2 ←	Serie	99
2: 10.7x ↓	7: 10.4 ↗		
3: 10.4 ↓	8: 10.8x →	Total	0
4: 10.8x ↙	9: 10.4 ↗		
5: 10.6x ↓	10: 10.7x ↗		

11: 10.2 ↑	16: 10.6x →	Serie	89
12: 9.9 →	17: 10.6x ←		
13: 10.0 ↗	18: 10.7x ←	Total	0
14: 10.0 ↗	19: 10.7x ←		
15: 10.5 ↘			

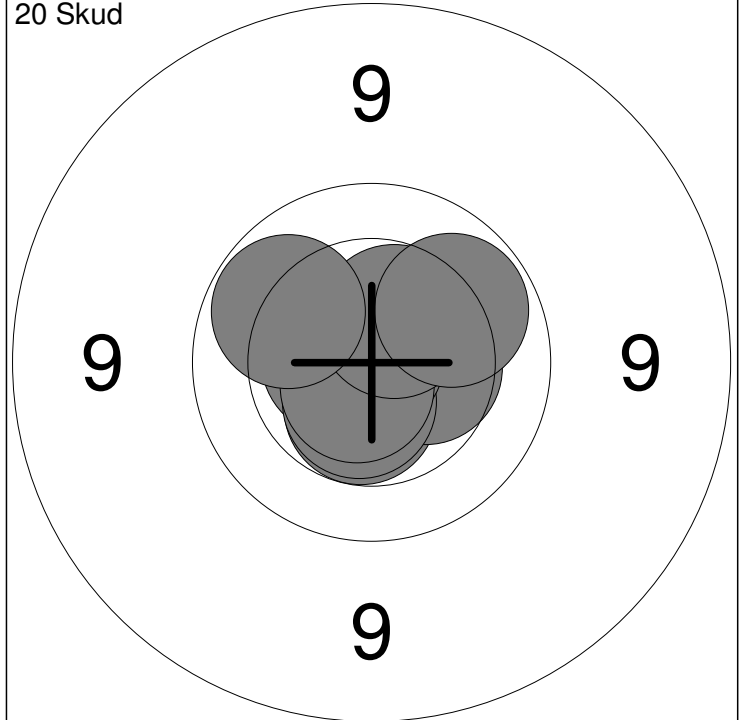
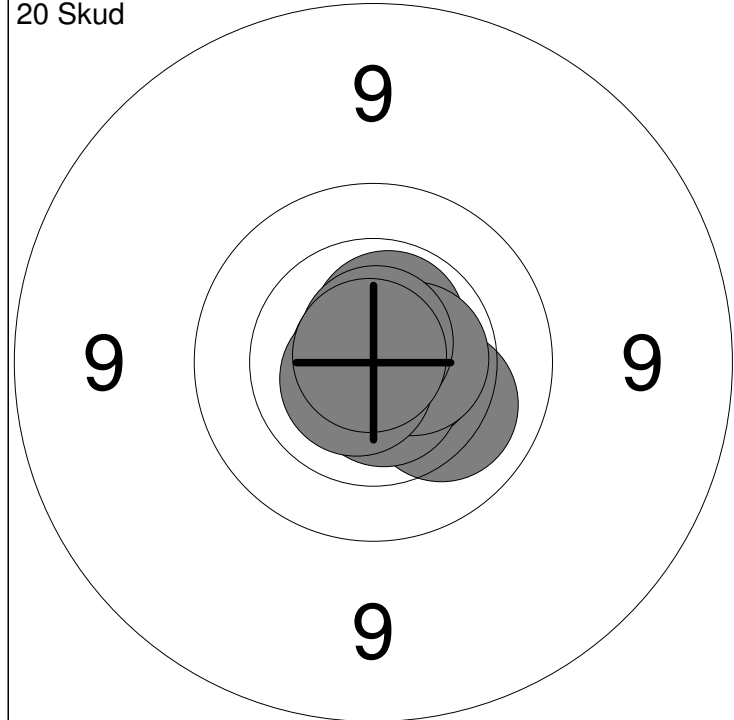

1: 10.2 ↘	6: 10.7x ↓	Serie	100
2: 10.7x →	7: 10.6x →		
3: 10.8x ↗	8: 10.8x ↗	Total	100
4: 10.6x ↗	9: 10.7x ↙		
5: 10.9x ↖	10: 10.9x ↗		

11: 10.5x ↓	16: 10.9x ↖	Serie	100
12: 10.4 →	17: 10.7x ↓		
13: 10.6x ←	18: 10.5x ↗	Total	200
14: 10.5x ↓	19: 10.0 ↖		
15: 10.7x ↖	20: 10.0 ↗		



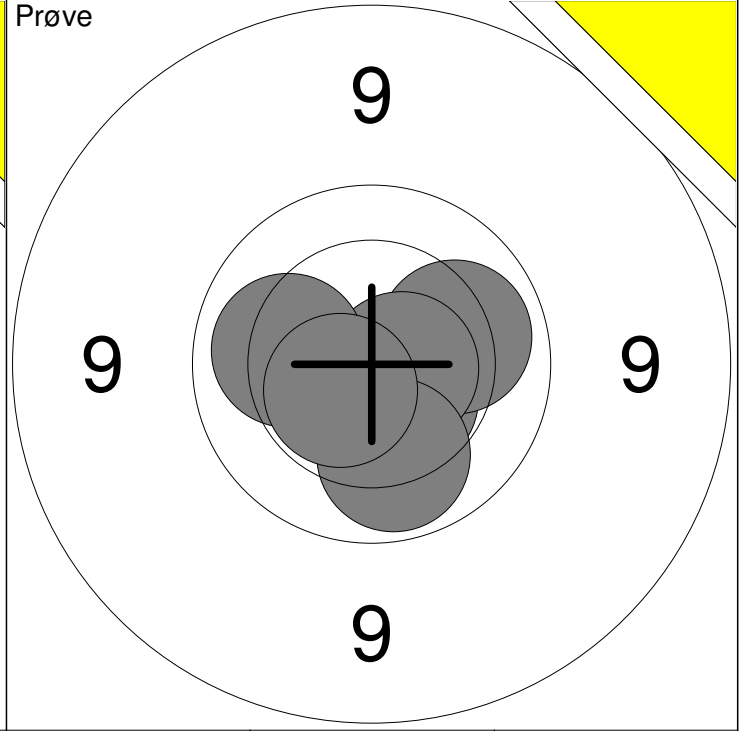
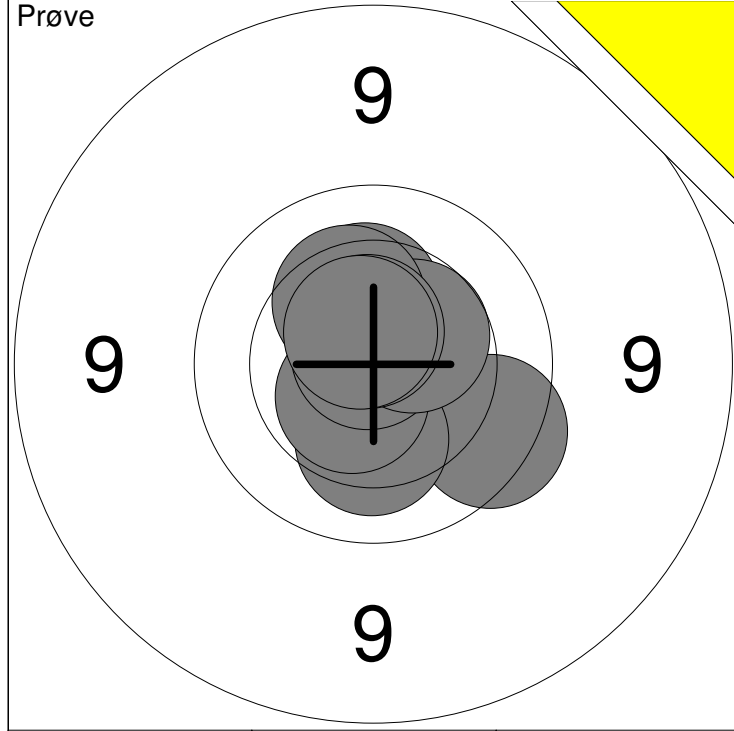

1: 9.8 ↘	6: 10.8x ↖	Serie	99
2: 10.2 ↓	7: 10.5 ↗		
3: 10.7x ↗	8: 10.3 ↖	Total	0
4: 10.3 ↑	9: 10.6x ↖		
5: 10.6x ↙	10: 10.6x ↖		

11: 10.5x ↘	16: 10.5x ↙	Serie	60
12: 10.1 →	13: 10.6x →		
14: 10.1 ←	15: 10.0 ↓	Total	0

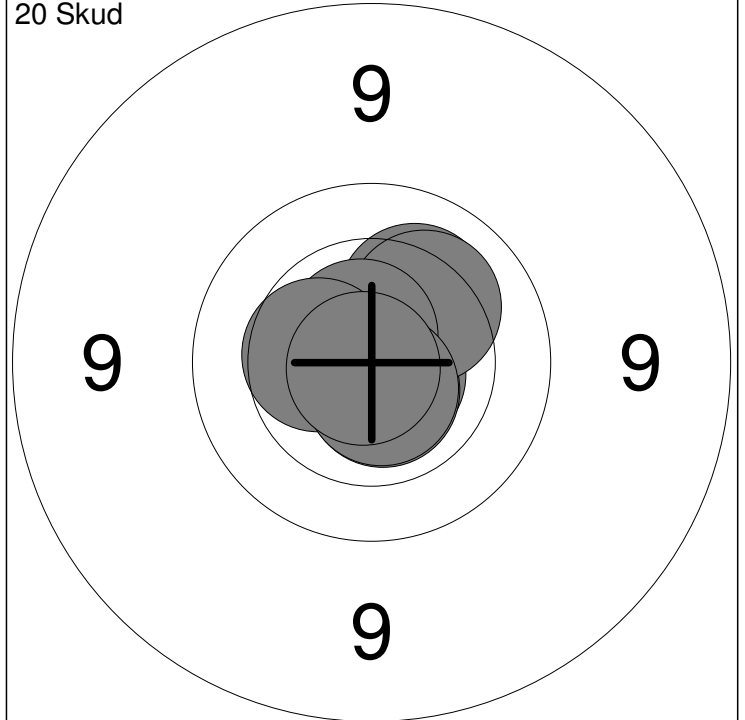
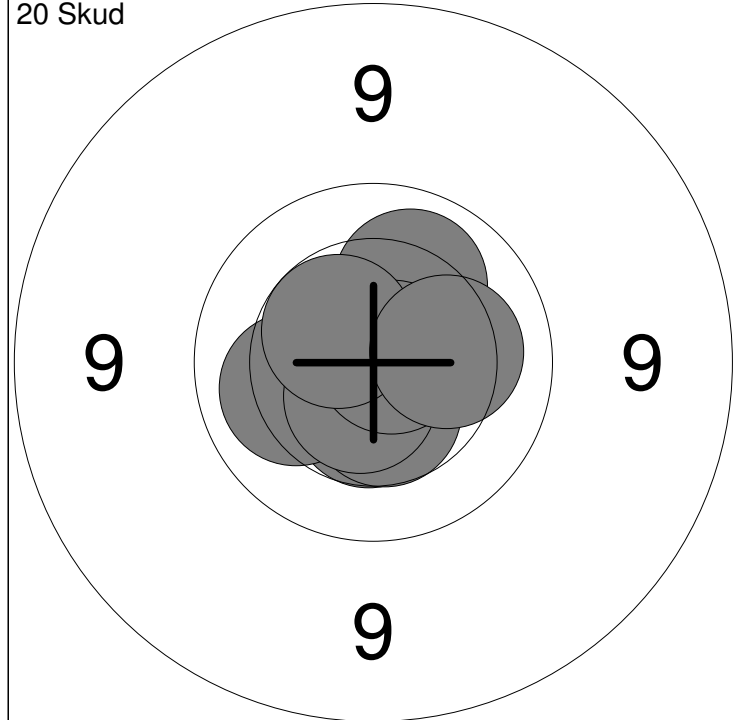

1: 10.8x ↙	6: 10.2 ←	Serie	100
2: 10.5 ↓	7: 10.6x ↓		
3: 10.5 ↓	8: 10.8x →	Total	100
4: 10.5 ↗	9: 10.5x ↖		
5: 10.1 ↗	10: 10.2 →		

11: 10.7x ↖	16: 10.2 ↗	Serie	100
12: 10.2 ↗	17: 10.7x ↖		
13: 10.7x ↘	18: 10.4 ←	Total	200
14: 10.7x ↓	19: 10.7x ↓		
15: 10.7x ↓	20: 10.9x ↙		

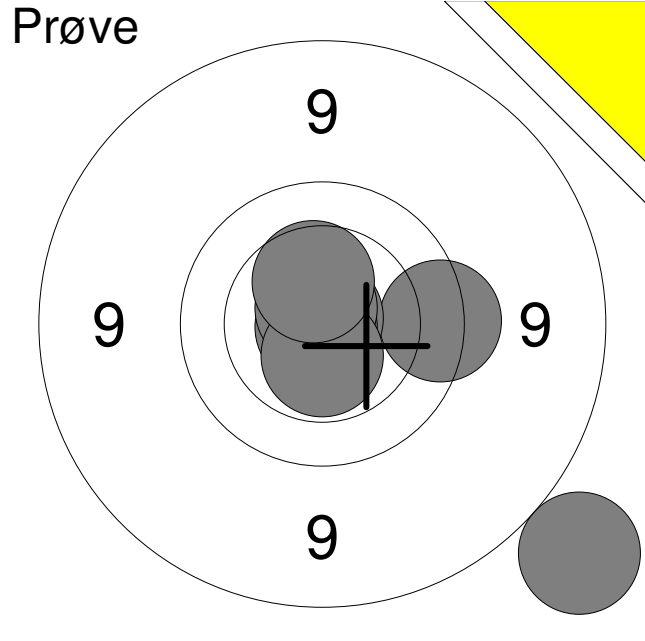
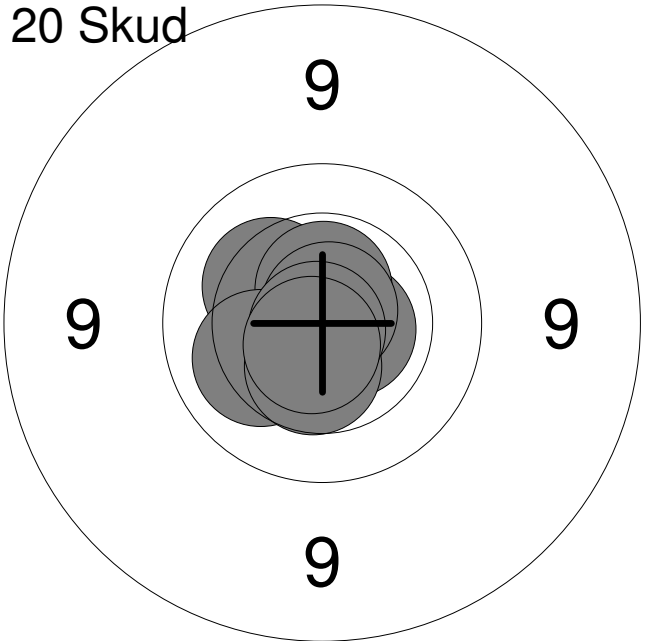
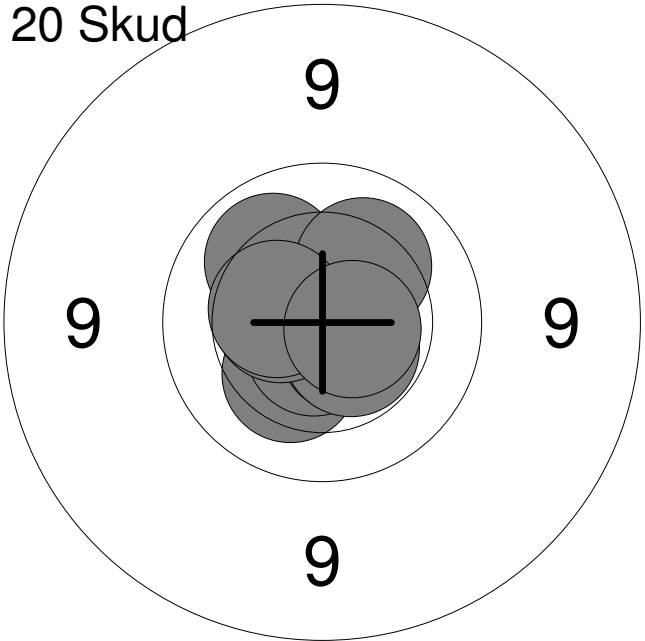
Hold	Skive	Liva Møller	
79	6	Vilsted Skf.	MB1
02.02.2017	NM 2017 ungdom riffel	Aalborg Skyttekreds	
<b>Prøve</b>		1: 8.4	↘
		2: 9.7	→
		3: 10.9x	↑
		4: 10.9x	↙
		5: 10.7x	↑
		6: 10.6x	↓
		7: 10.4	↑
		<b>Serie</b>	<b>67.0</b>
		<b>Total</b>	<b>0.0</b>
<b>20 Skud</b>		1: 10.7x	↙
		2: 10.7x	↓
		3: 10.7x	→
		4: 10.3	↗
		5: 10.6x	↑
		6: 10.2	↙
		7: 10.8x	↗
		8: 10.5	↓
		9: 10.8x	↘
		10: 10.7x	↘
		<b>Serie</b>	<b>100.0</b>
		<b>Total</b>	<b>100.0</b>
<b>20 Skud</b>		11: 10.7x	↓
		12: 10.3	↘
		13: 10.7x	↘
		14: 10.6x	↘
		15: 10.1	↗
		16: 10.5x	↘
		17: 10.5	↙
		18: 10.2	↗
		19: 10.4	↙
		20: 10.6x	→
		<b>Serie</b>	<b>100.0</b>
		<b>Total</b>	<b>200.0</b>

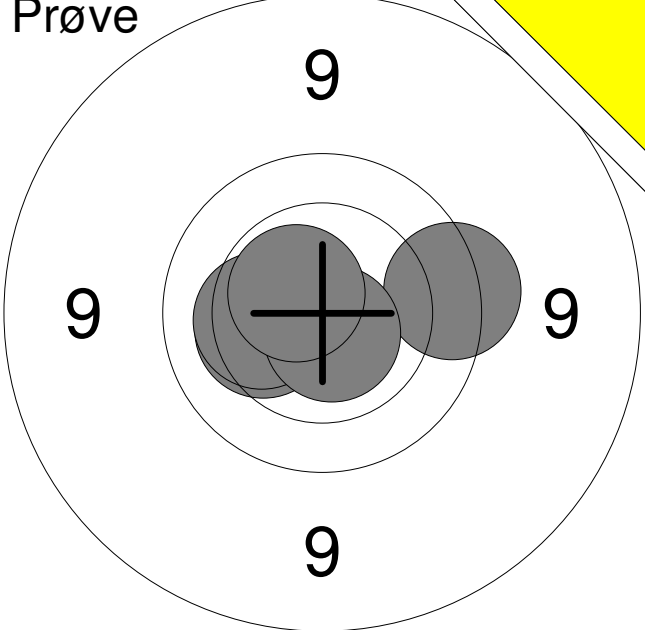
<b>Prøve</b> 	1: 9.7 →
	2: 10.3 ←
	3: 10.3 ←
	4: 10.7x ↓
	5: 10.6x ↗
<b>Serie</b>	<b>49.0</b>
<b>Total</b>	<b>0.0</b>

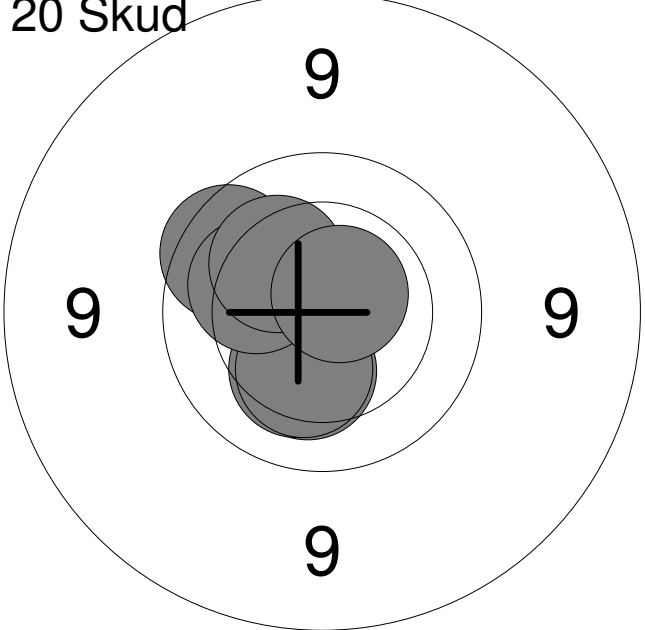
<b>20 Skud</b> 	1: 10.7x ←
	2: 10.5x ←
	3: 10.6x ↗
	4: 10.3 ↓
	5: 10.3 ↓
	6: 10.3 ↓
	7: 9.8 ↗
	8: 10.2 ←
	9: 10.2 ↗
	10: 10.7x ↗
<b>Serie</b>	<b>99.0</b>
<b>Total</b>	<b>99.0</b>

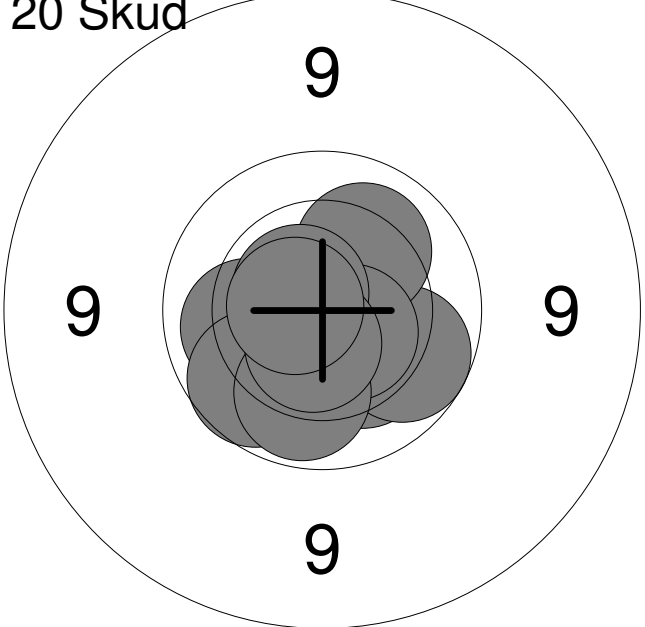
<b>20 Skud</b> 	11: 10.3 ↓
	12: 10.1 ←
	13: 9.9 ↓
	14: 10.2 ↗
	15: 10.6x ↓
	16: 10.6x ↗
	17: 9.9 ←
	18: 10.0 ↓
	19: 10.6x ↓
	20: 10.6x ←
<b>Serie</b>	<b>98.0</b>
<b>Total</b>	<b>197.0</b>

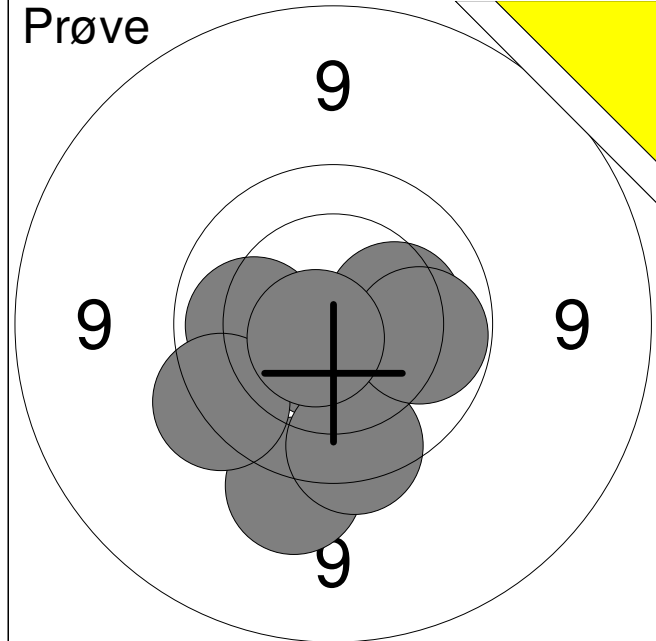

1:	9.5	↓
2:	10.3	→
3:	10.6x	↓
4:	9.7	↓
5:	10.1	←
6:	10.0	→
7:	9.7	↙
8:	10.7x	↙
<b>Serie</b>		<b>77.0</b>
<b>Total</b>		<b>0.0</b>

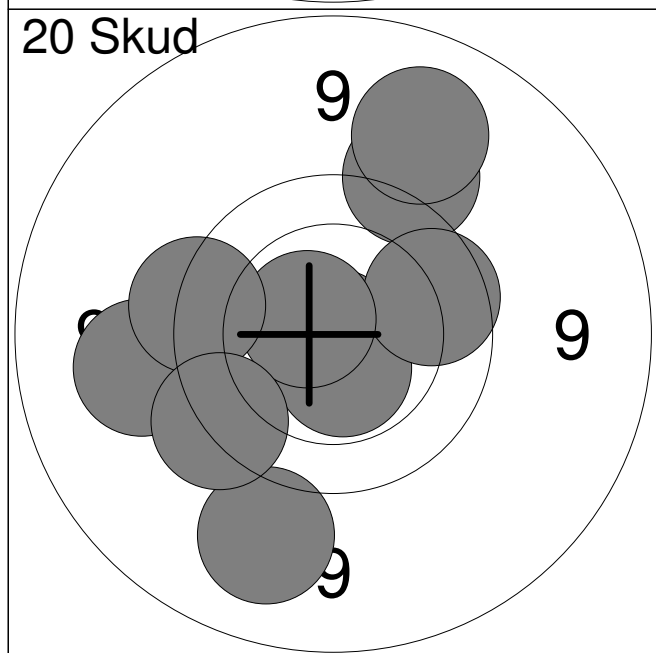

1:	9.3	←
2:	9.2	↓
3:	10.9x	↓
4:	10.6x	↓
5:	9.4	↗
6:	9.9	→
7:	10.6x	↖
8:	9.6	←
9:	9.2	↗
10:	9.6	↙
<b>Serie</b>		<b>93.0</b>
<b>Total</b>		<b>93.0</b>

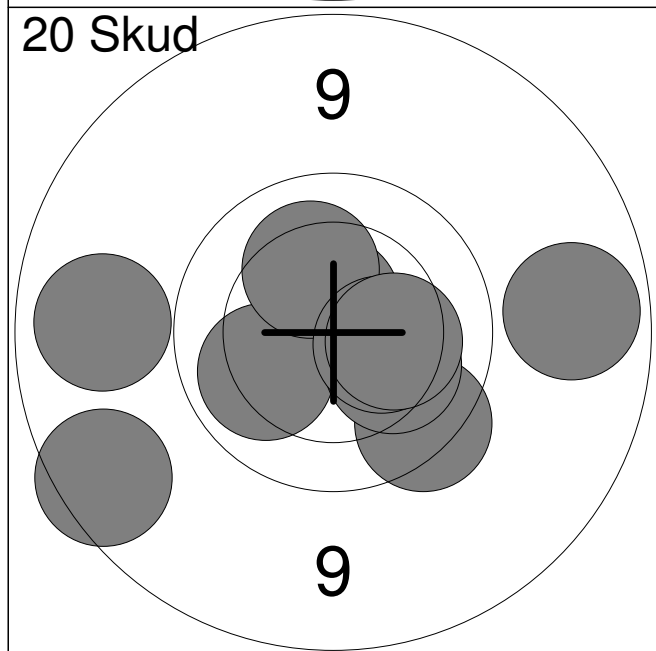

11:	9.1	←
12:	10.6x	↑
13:	9.0	→
14:	9.7	↓
15:	10.1	↙
16:	10.2	↘
17:	8.9	↙
18:	10.2	↗
19:	10.4	→
20:	10.3	→
<b>Serie</b>		<b>95.0</b>
<b>Total</b>		<b>188.0</b>

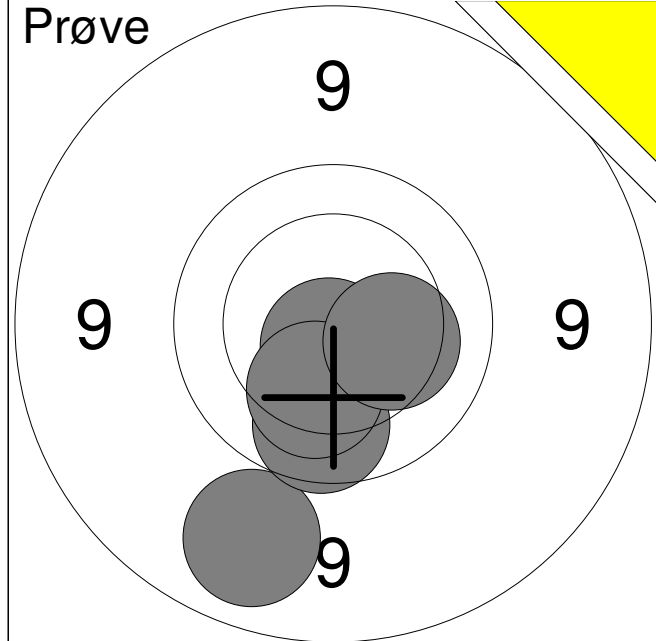

1:	9.1	↘
2:	9.9	↘
3:	10.7x	↘
4:	10.2	↘
5:	10.3	→
<b>Serie</b>		<b>48.0</b>
<b>Total</b>		<b>0.0</b>

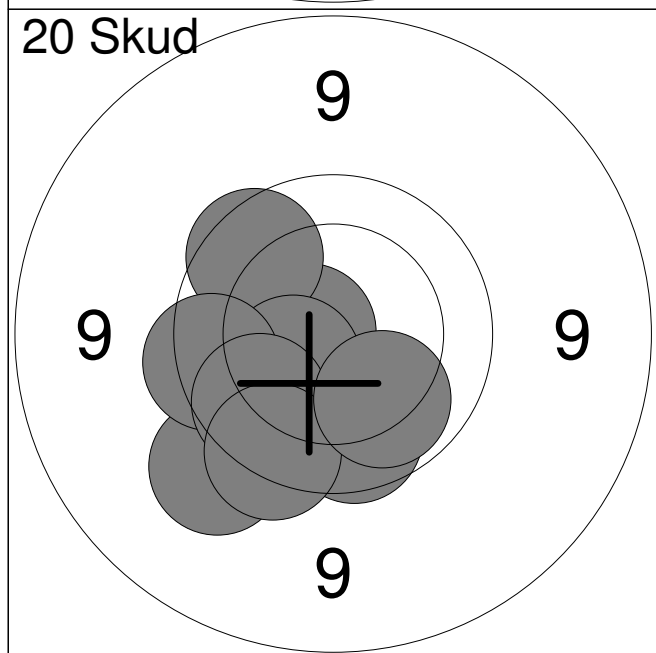

1:	9.4	↘
2:	10.7x	←
3:	9.8	↗
4:	9.9	↘
5:	10.4	↙
6:	9.9	↘
7:	9.7	←
8:	9.9	↙
9:	9.7	↘
10:	10.1	↘
<b>Serie</b>		<b>93.0</b>
<b>Total</b>		<b>93.0</b>

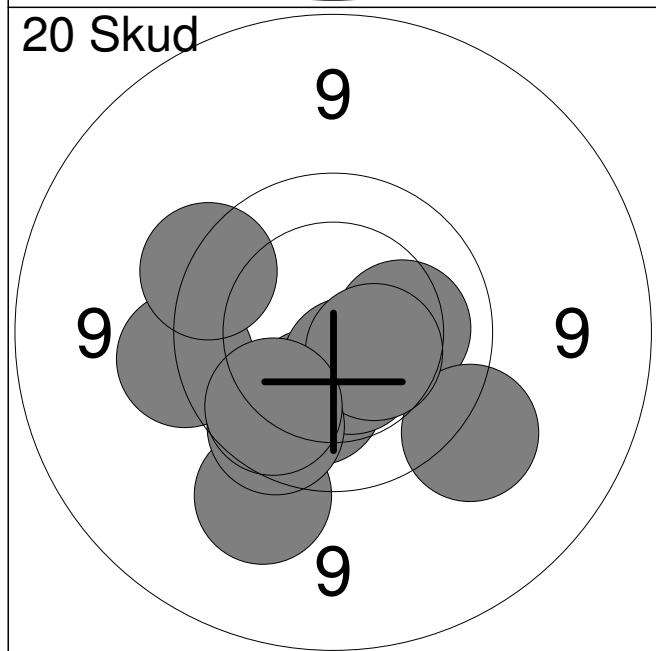

11:	9.4	↘
12:	9.6	←
13:	10.2	→
14:	10.2	↘
15:	9.5	↘
16:	10.5x	↘
17:	9.6	↗
18:	10.4	↘
19:	9.8	↘
20:	9.9	↘
<b>Serie</b>		<b>94.0</b>
<b>Total</b>		<b>187.0</b>

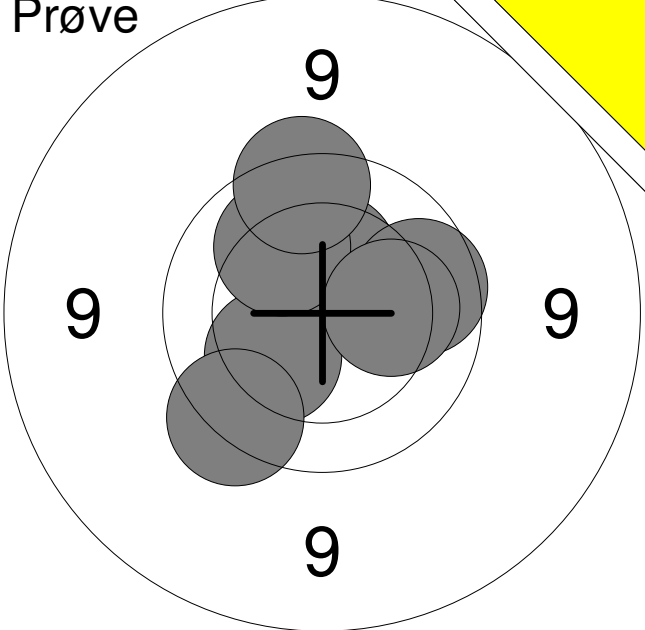
<b>Prøve</b> 	1:	10.4	↑
	2:	9.9	→
	3:	10.2	↙
	4:	10.1	↗
	5:	9.7	↑
	6:	10.2	→
	7:	9.7	↘
	<b>Serie</b>		<b>67.0</b>
<b>Total</b>		<b>0.0</b>	

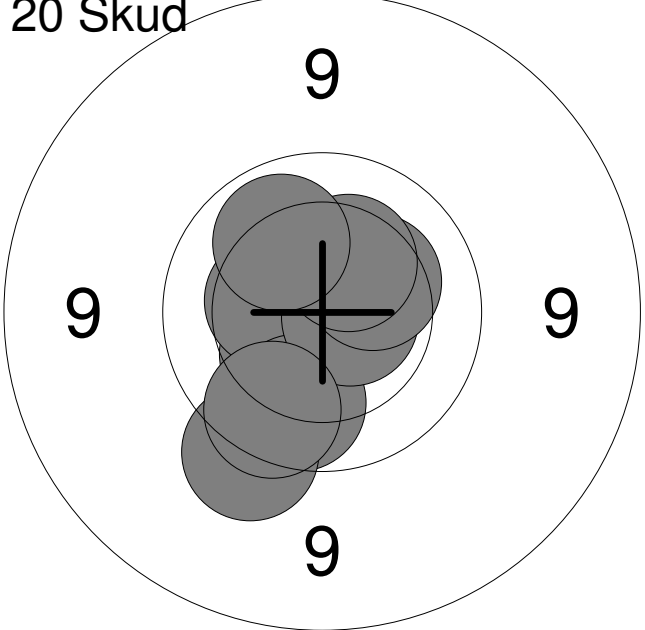
<b>20 Skud</b> 	1:	10.4	↙
	2:	10.3	↗
	3:	10.4	←
	4:	9.9	↓
	5:	10.6x	→
	6:	10.3	↗
	7:	10.3	↗
	8:	10.1	↗
	9:	9.5	↘
	10:	9.8	↘
<b>Serie</b>		<b>97.0</b>	
<b>Total</b>		<b>97.0</b>	

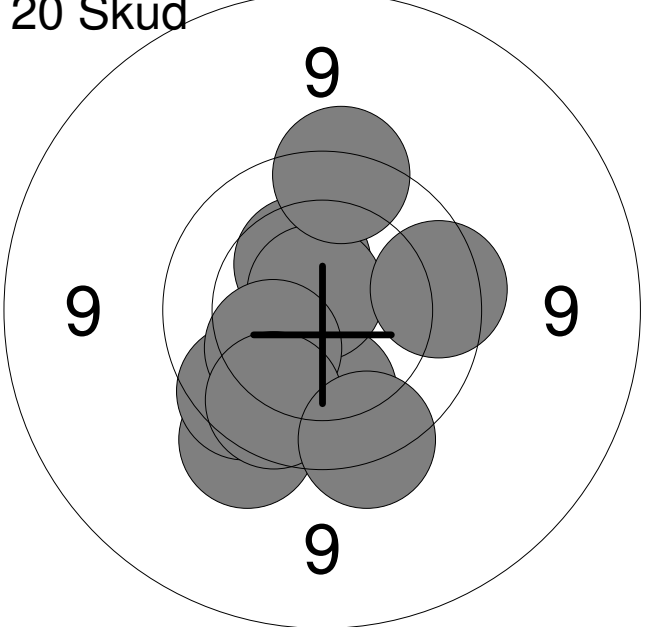
<b>20 Skud</b> 	11:	10.0	↓
	12:	10.4	↗
	13:	9.6	↘
	14:	10.7x	↗
	15:	9.8	↘
	16:	10.3	↙
	17:	9.9	↘
	18:	9.7	↓
	19:	9.8	→
	20:	9.7	↑
<b>Serie</b>		<b>94.0</b>	
<b>Total</b>		<b>191.0</b>	

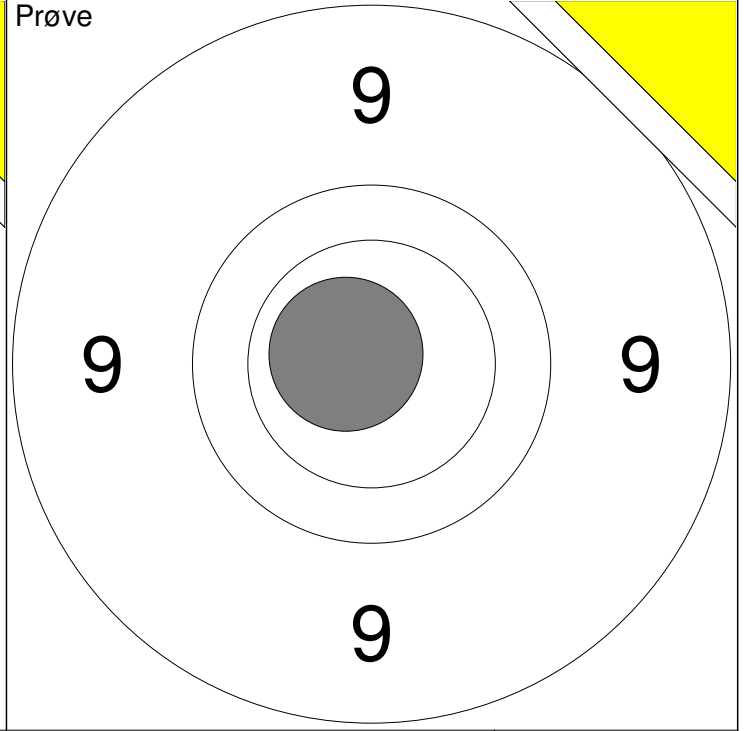
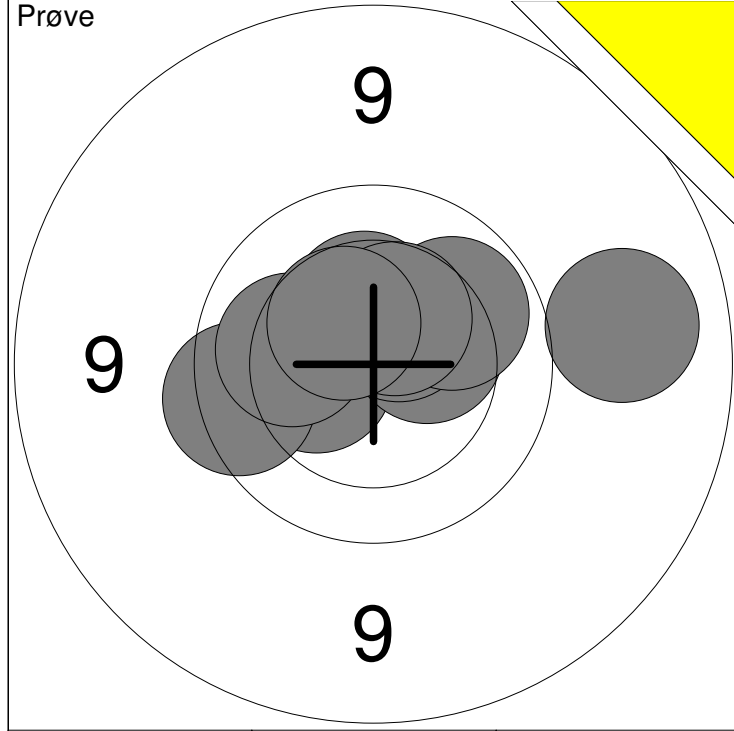

1: 10.4 ←	6: 9.1 →	Serie	98
2: 9.7 ←	7: 10.5 ↗		
3: 10.1 ←	8: 10.0 ↗	Total	0
4: 10.4 →	9: 10.5 ↗		
5: 10.4 ↑	10: 10.5 ↖		

11: 10.7x ←	Serie	10
	Total	0

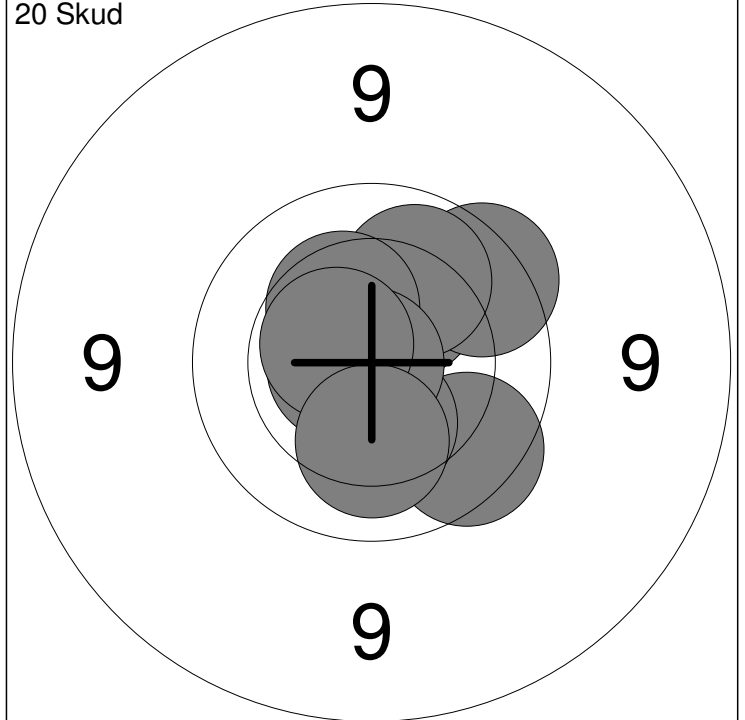
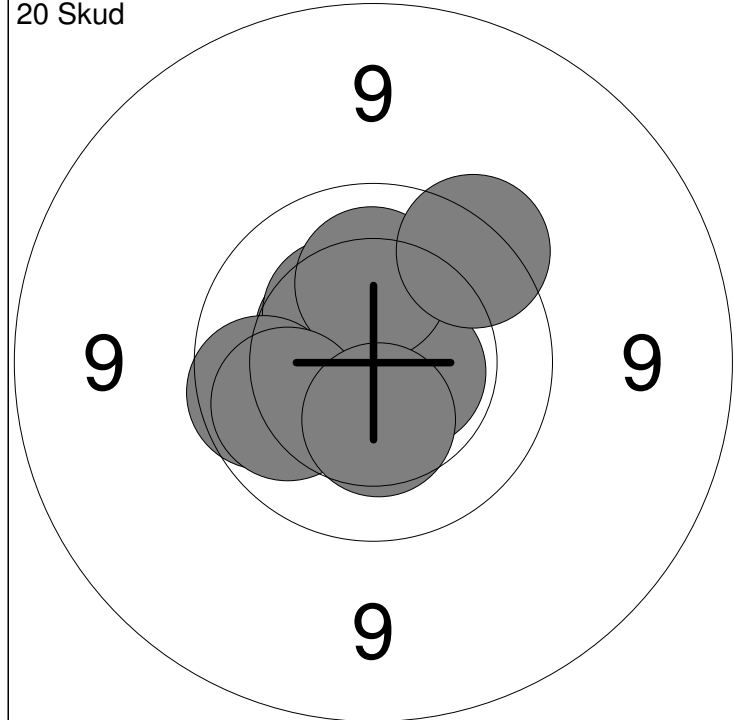

1: 10.5 ↖	6: 10.2 ↑	Serie	98
2: 10.7x ↑	7: 9.9 ←		
3: 10.8x ←	8: 10.0 ←	Total	98
4: 10.6x →	9: 10.4 ↓		
5: 10.4 ↖	10: 9.7 ↗		

11: 10.3 ↗	16: 10.3 ↖	Serie	98
12: 9.7 ↗	17: 10.4 ↓		
13: 10.1 ↗	18: 10.9x ←	Total	196
14: 9.8 ↘	19: 10.6x ↖		
15: 10.7x ←	20: 10.2 ↓		

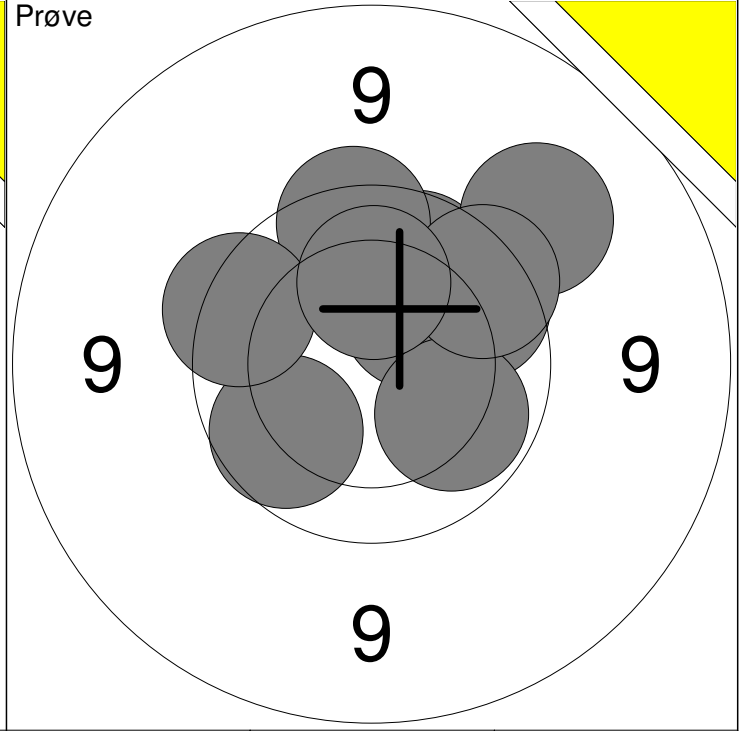
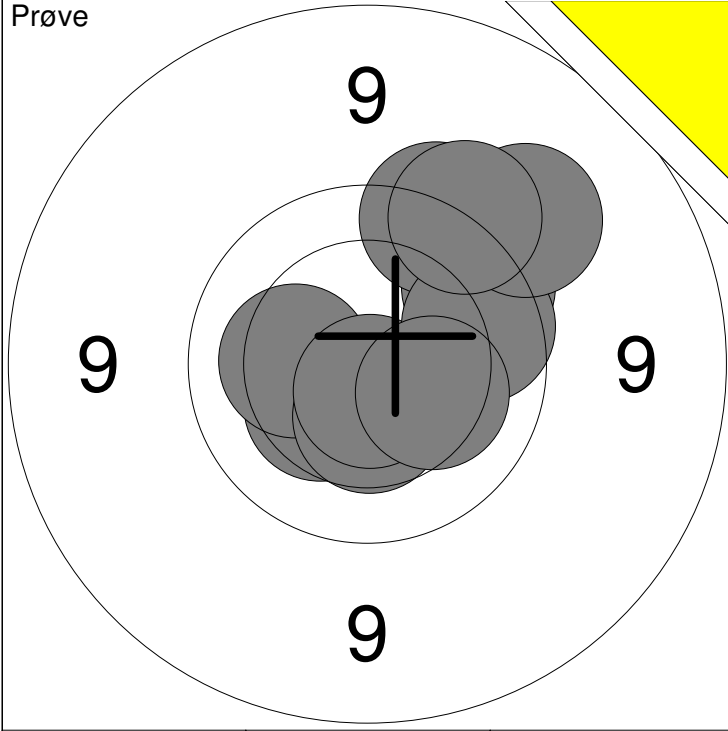

1: 9.8 ↗	6: 10.7x ↓	Serie	95
2: 10.3 ↙	7: 9.9 →		
3: 10.2 ←	8: 9.3 ↗	Total	0
4: 10.4 ↓	9: 10.3 ↘		
5: 9.6 ↗	10: 9.5 ↗		

11: 9.9 ↗	16: 9.3 ↗	Serie	93
12: 10.3 ↗	17: 10.0 ↘		
13: 9.9 ↙	18: 9.7 ↗	Total	0
14: 9.7 ↑	19: 9.7 ←		
15: 9.9 ↗	20: 10.2 ↑		

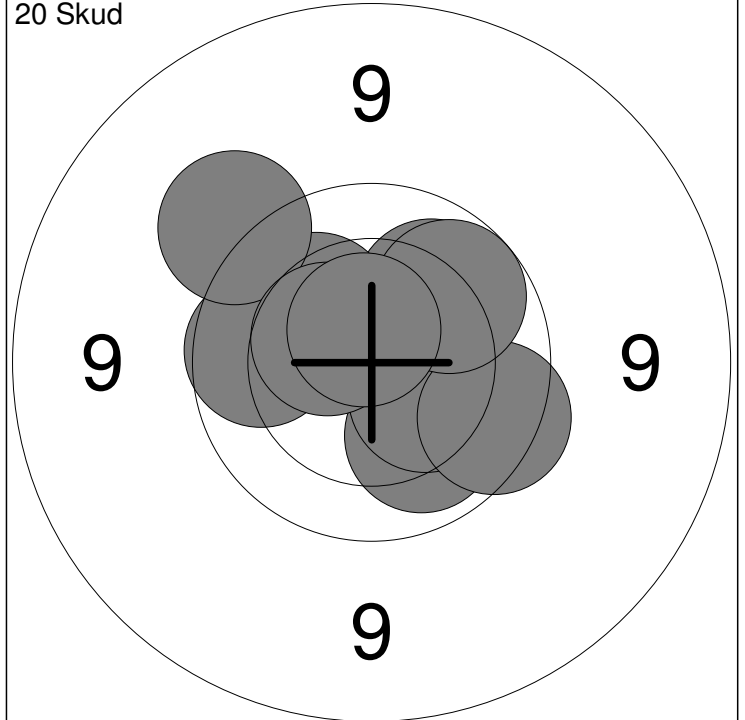
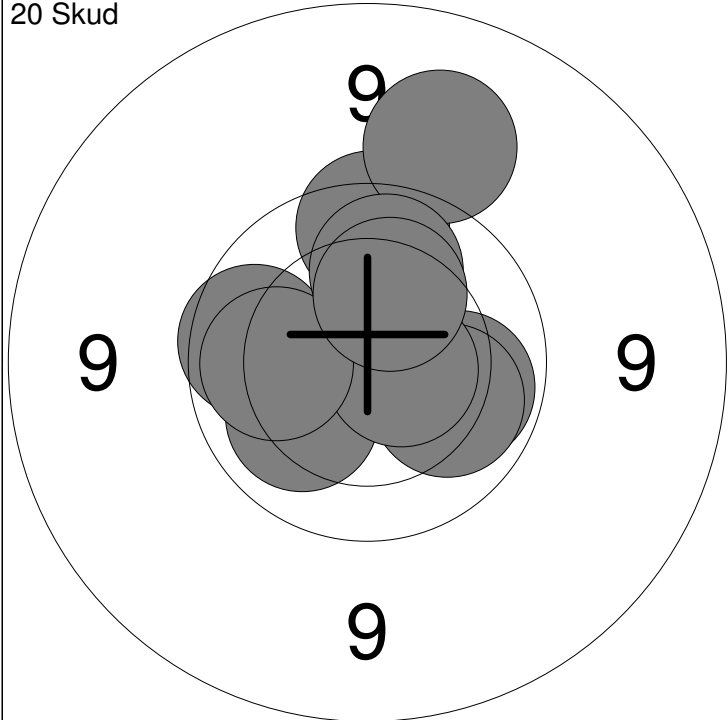

1: 9.8 ↑	6: 9.3 ↑	Serie	97
2: 10.0 →	7: 10.6x →		
3: 9.9 ←	8: 10.0 ↑	Total	97
4: 10.1 ↙	9: 10.1 ←		
5: 10.1 ↘	10: 10.2 ↑		

11: 10.1 ↗	16: 9.4 ↙	Serie	96
12: 10.2 ↗	17: 9.8 ↘		
13: 10.1 ↓	18: 9.9 ↗	Total	193
14: 10.3 ↘	19: 10.5 ←		
15: 9.9 ←	20: 10.6x ↑		



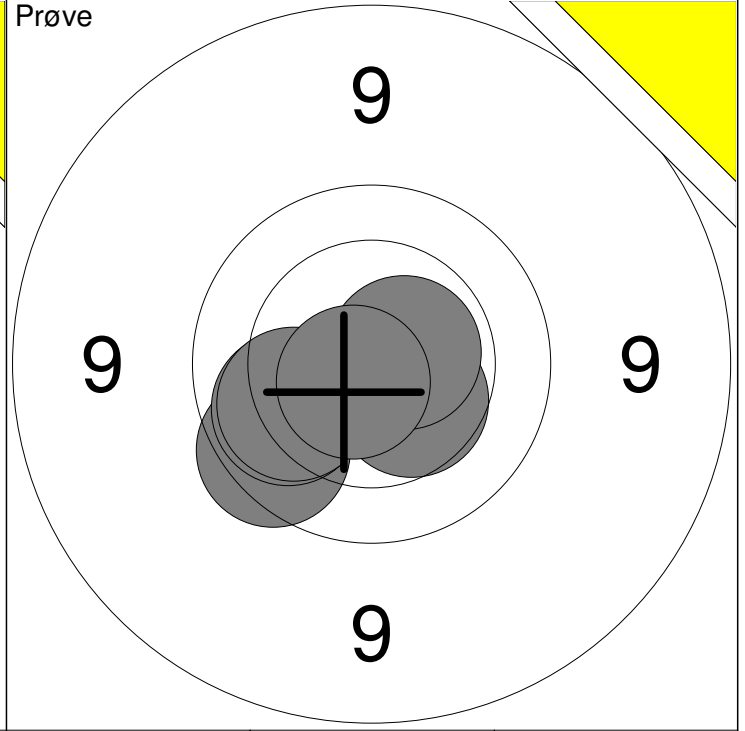
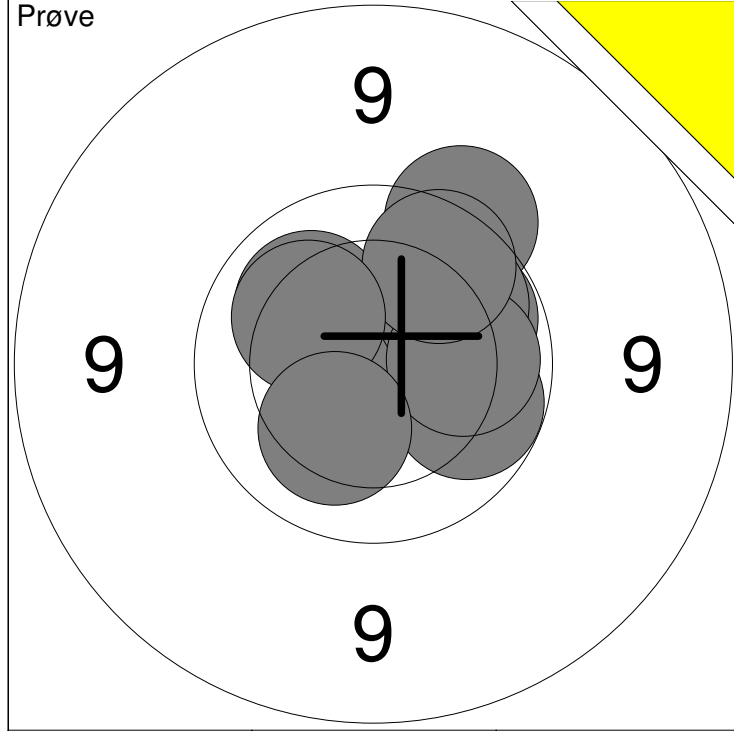

1: 9.6 ↗	6: 10.0 ↗	Serie	98
2: 10.1 ↖	7: 10.1 →		
3: 10.0 ↗	8: 9.9 ↗	Total	0
4: 10.8x ↗	9: 10.2 ↖		
5: 10.0 ↘	10: 10.2 ↘		

11: 9.8 ↙	16: 10.7x ↙	Serie	59
12: 10.0 ↙	13: 10.4 ↘		
14: 10.1 ↙	15: 10.6x →	Total	0

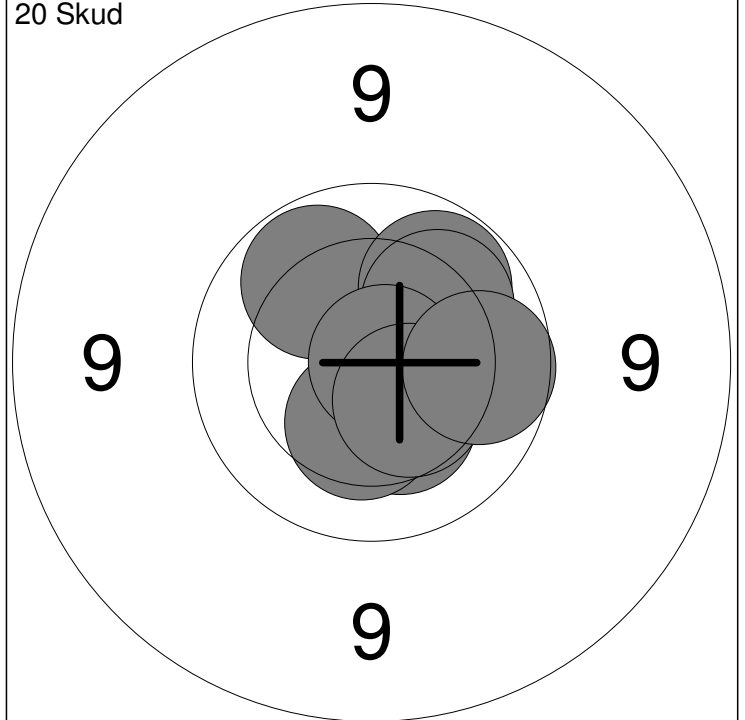
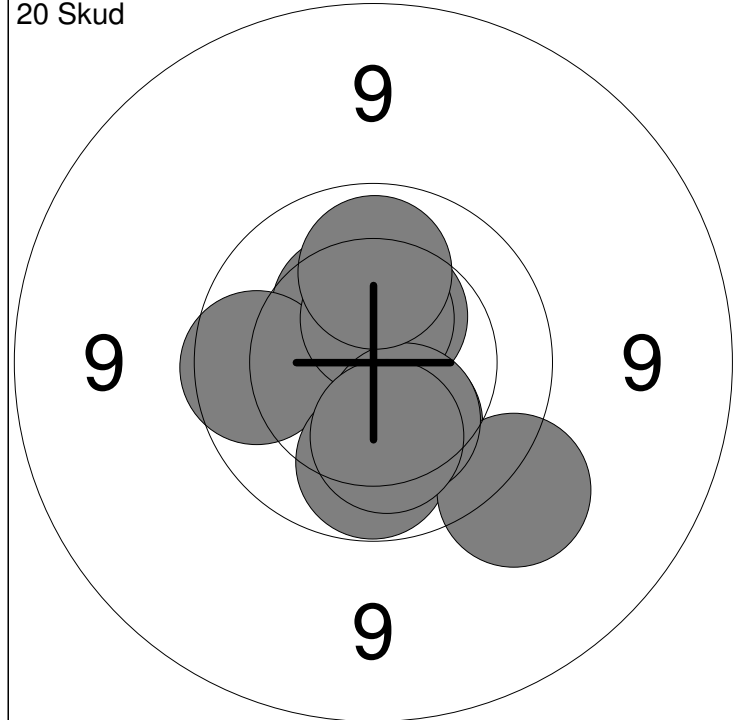

1: 10.4 ↗	6: 10.0 ↓	Serie	98
2: 10.5 ↗	7: 9.5 ↘		
3: 10.3 ↘	8: 10.3 ↘	Total	98
4: 9.9 ←	9: 10.2 ↘		
5: 10.5x ↑	10: 10.1 ↑		

11: 10.5x →	16: 10.0 ↗	Serie	99
12: 10.3 ↘	17: 10.1 ↗		
13: 10.3 ↘	18: 10.8x →	Total	197
14: 10.5x →	19: 10.4 ↘		
15: 10.0 ↗	20: 9.9 →		

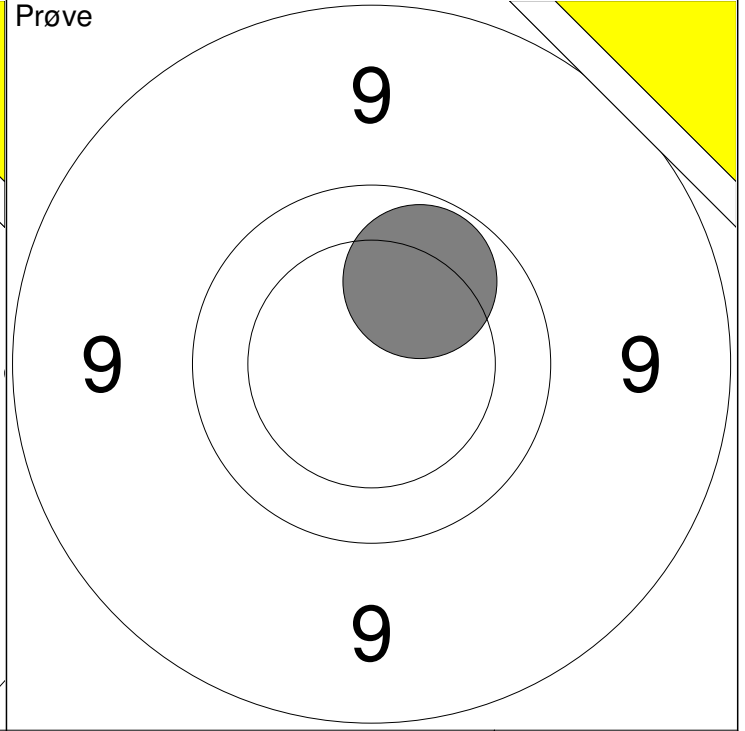
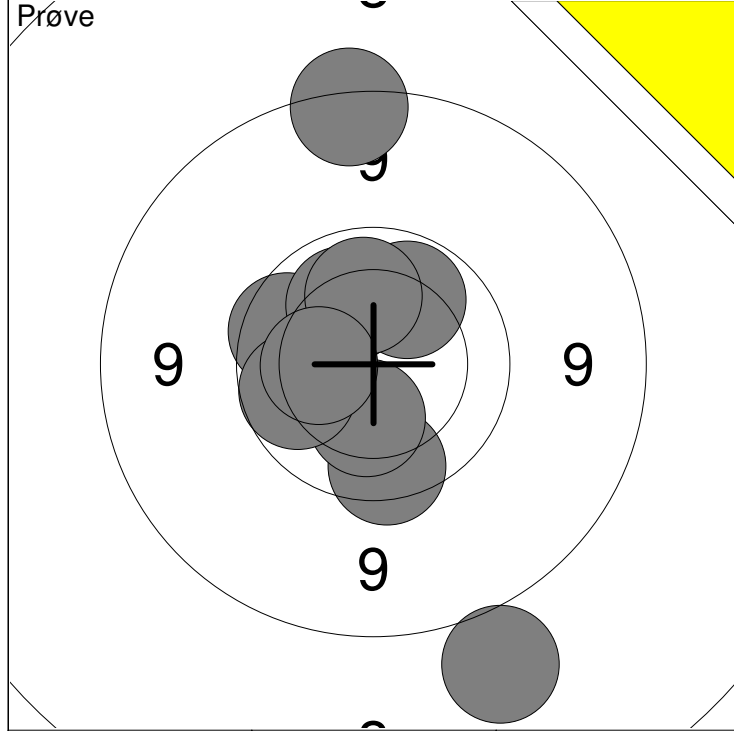

1: 8.4 ↓	6: 10.3 ↓	Serie	93
2: 9.8 ↓	7: 10.1 ↑		
3: 10.0 ↗	8: 9.9 ←	Total	0
4: 9.8 ↖	9: 8.7 ↑		
5: 10.1 ↗	10: 10.2 ←		

11: 10.0 ↗	Serie	10
	Total	0

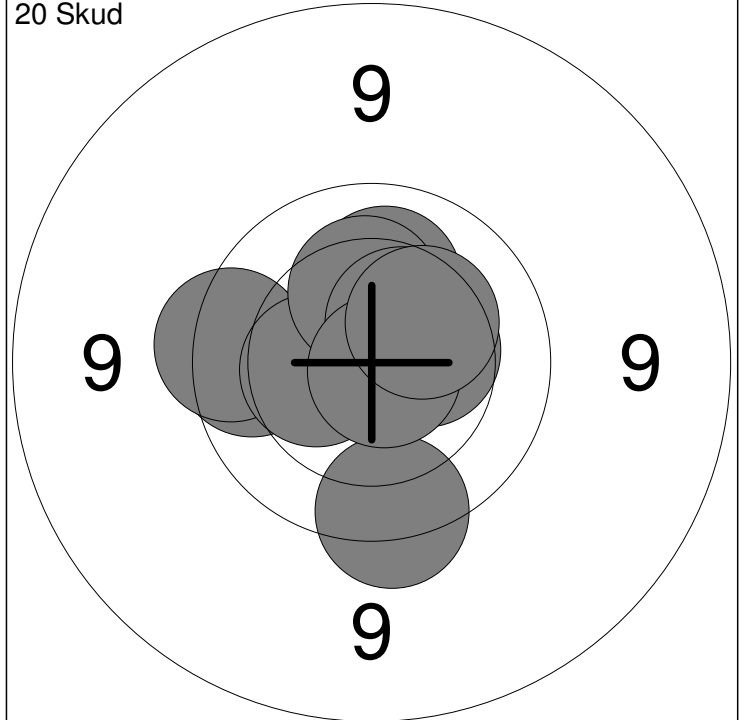
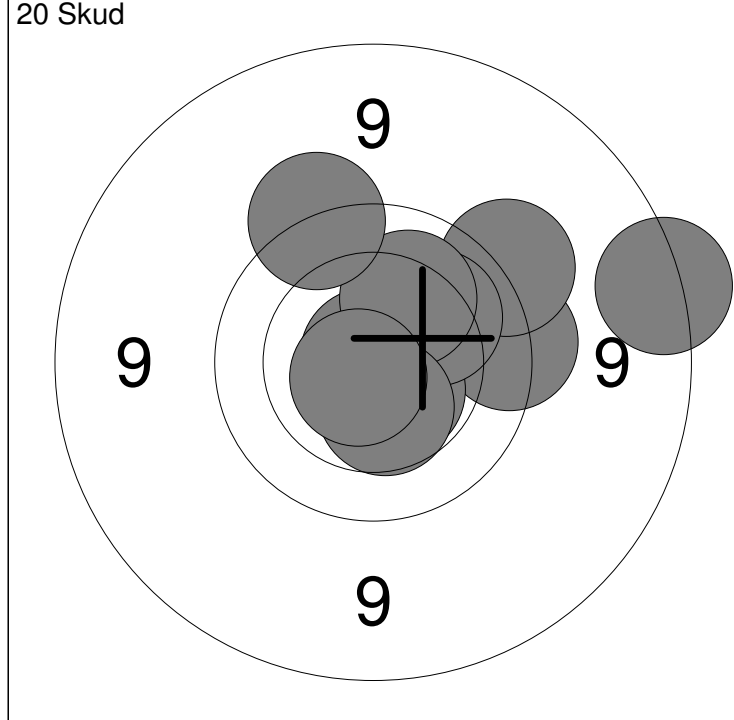

1: 8.7 →	6: 10.1 ↗	Serie	95
2: 10.9x ↖	7: 10.2 ↗		
3: 9.7 →	8: 9.6 ↗	Total	95
4: 9.5 ↗	9: 10.4 ↓		
5: 10.6x ↓	10: 10.7x ↘		

11: 10.4 →	16: 10.2 ↑	Serie	97
12: 9.7 ↓	17: 10.3 ↑		
13: 9.9 ←	18: 10.5 ↗	Total	192
14: 9.7 ←	19: 10.8x ↘		
15: 10.4 ←	20: 10.3 ↗		

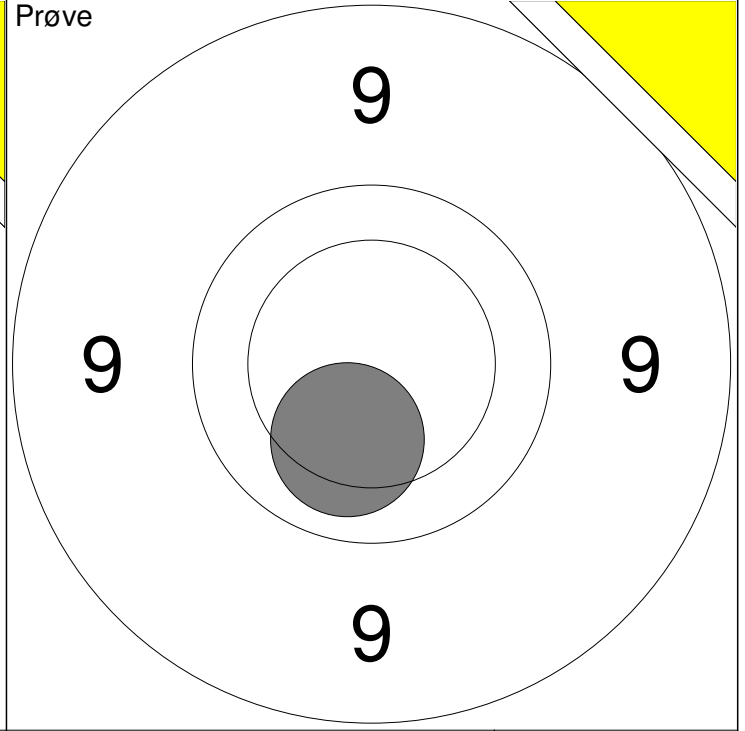
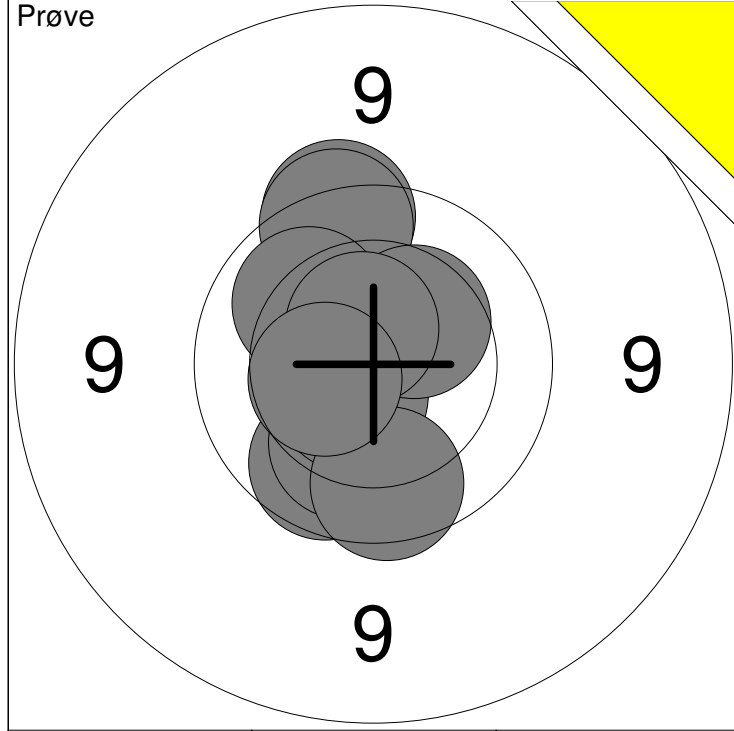

1: 9.9 ↙	6: 10.4 ↗	Serie	96
2: 10.1 ↘	7: 10.1 ↖		
3: 10.6x ↙	8: 9.8 ↓	Total	0
4: 9.7 ↗	9: 10.6x ↗		
5: 9.7 ↗	10: 10.4 ←		

11: 10.2 ↓	Serie	10
	Total	0

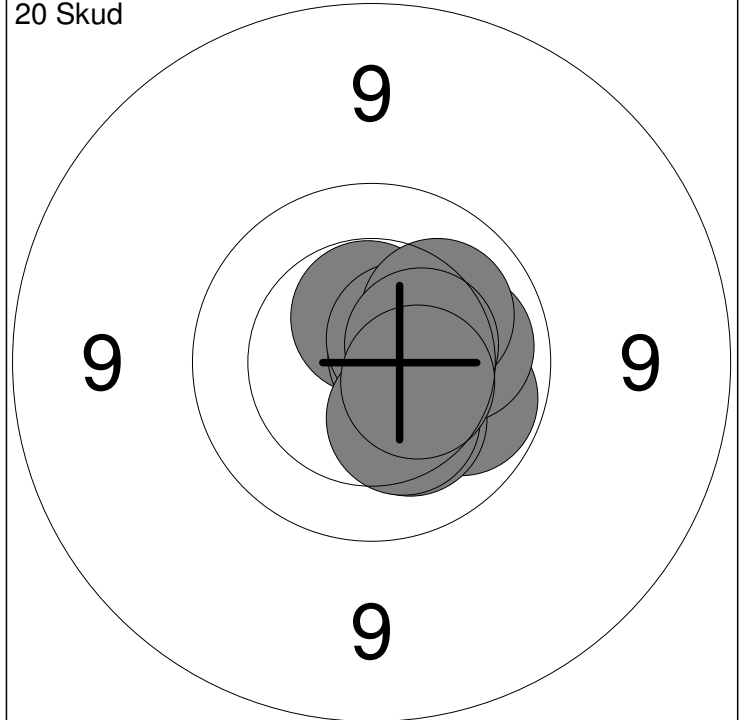
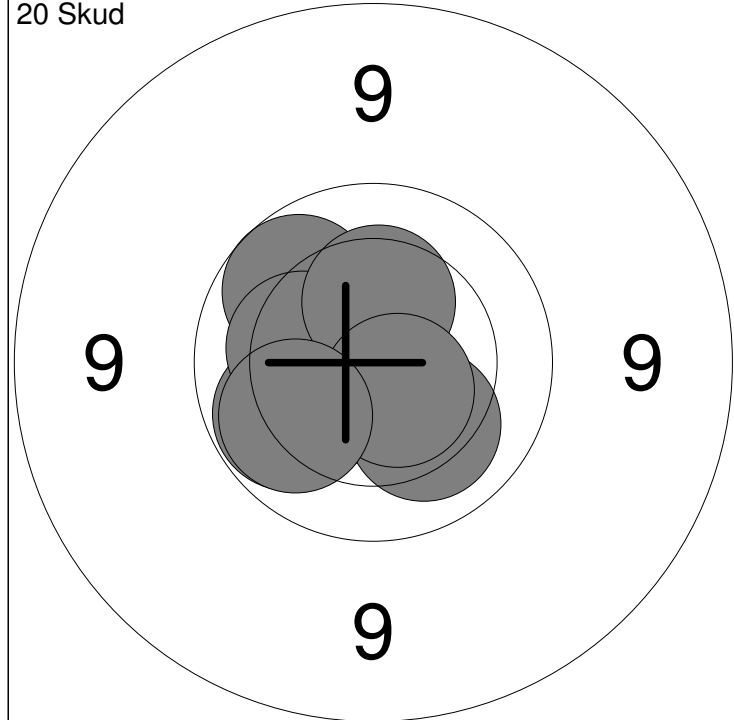

1: 10.2 ↖	6: 10.2 ←	Serie	99
2: 10.3 ↗	7: 10.2 ↓		
3: 9.9 ↗	8: 10.4 ↗	Total	99
4: 10.0 ↖	9: 10.6x ↓		
5: 10.7x ↘	10: 10.0 ↖		

11: 10.5x ↗	16: 10.6x ↗	Serie	100
12: 10.0 →	17: 10.3 ↓		
13: 10.3 ↓	18: 10.2 ↗	Total	199
14: 10.6x →	19: 10.4 →		
15: 10.1 →	20: 10.5 ↘		

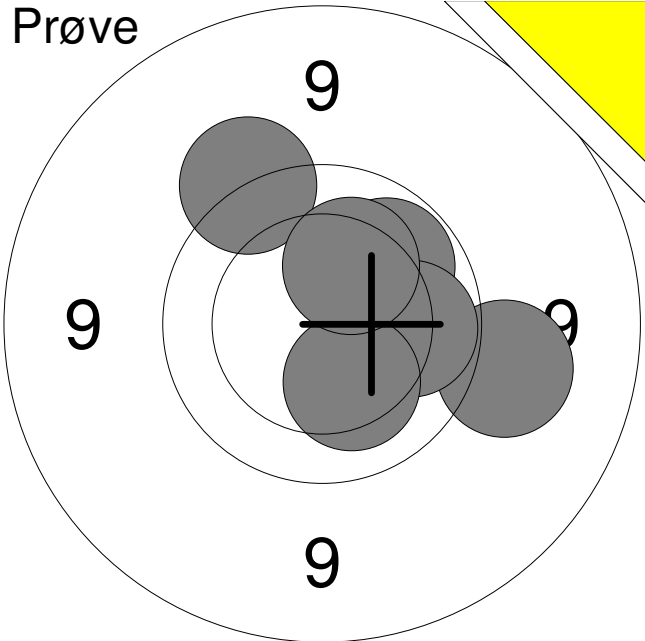
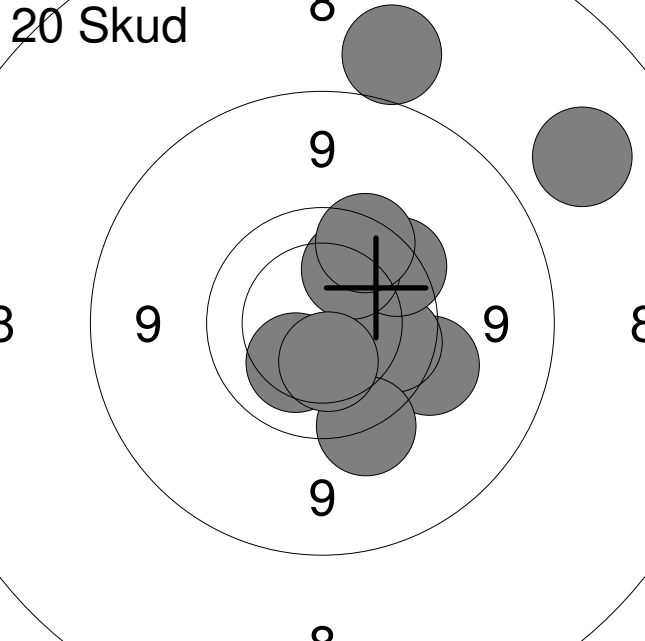
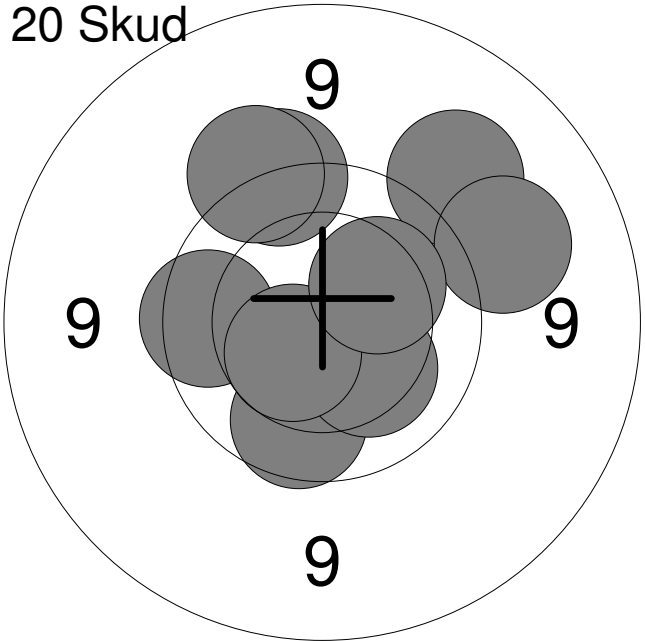
Hold	Skive	Mads Rømer	
80	11		
AAS		Hjørring Skytteforening	BK3
02.02.2017	NM 2017 ungdom riffel	Aalborg Skyttekreds	
Prøve		1: 9.3 → 2: 10.0 ↗ 3: 9.5 ↗ 4: 10.0 → 5: 10.2 ↓ 6: 10.2 ↗	
		Serie	58.0
		Total	0.0
20 Skud		1: 9.5 ↘ 2: 9.9 → 3: 8.2 ↗ 4: 9.7 ↗ 5: 9.6 ↓ 6: 8.4 ↑ 7: 10.0 ↗ 8: 10.2 ↓ 9: 9.7 ↗ 10: 10.4 ↓	
		Serie	91.0
		Total	91.0
20 Skud		11: 9.9 ↓ 12: 9.3 ↗ 13: 10.6x ↓ 14: 9.8 ← 15: 10.2 ↓ 16: 9.6 ↑ 17: 9.5 ↗ 18: 10.5 ↓ 19: 9.3 → 20: 10.2 ↗	
		Serie	94.0
		Total	185.0

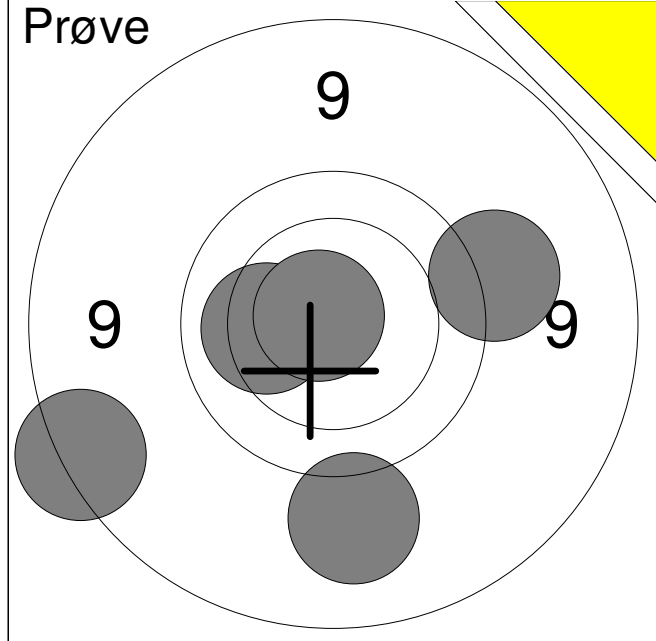

1:	8.8	↙
2:	9.2	↓
3:	9.4	→
4:	10.2	←
5:	10.8x	↖
<b>Serie</b>		<b>46.0</b>
<b>Total</b>		<b>0.0</b>

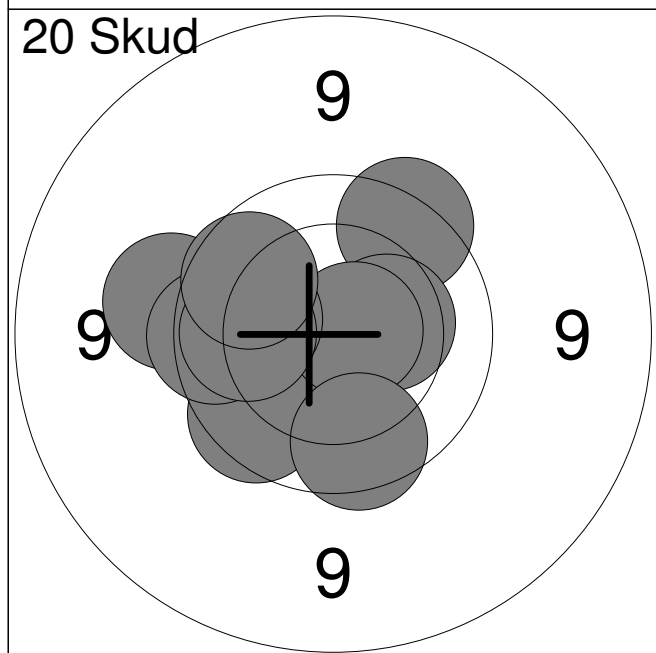

1:	9.5	←
2:	9.7	↗
3:	9.8	↙
4:	10.3	→
5:	10.7x	→
6:	10.1	←
7:	9.8	←
8:	9.8	↓
9:	10.0	←
10:	9.9	↖
<b>Serie</b>		<b>94.0</b>
<b>Total</b>		<b>94.0</b>

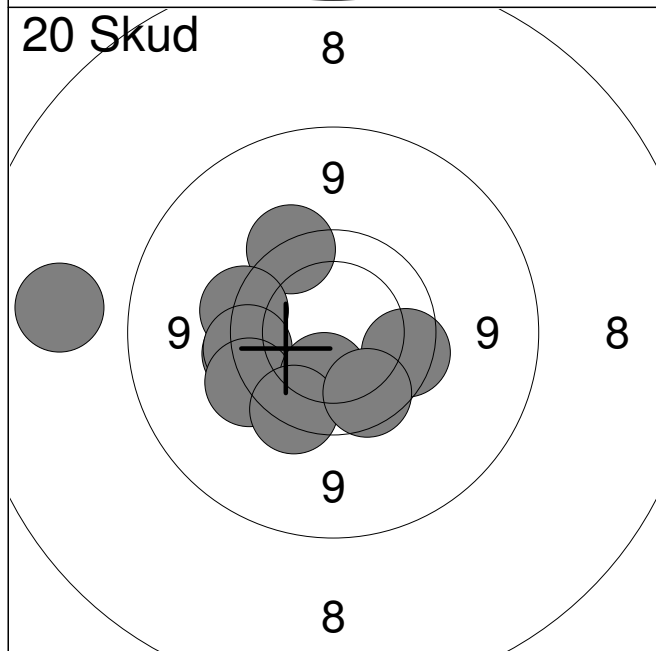

11:	9.6	↗
12:	9.6	←
13:	9.6	←
14:	9.7	←
15:	8.2	←
16:	9.6	↙
17:	10.2	↓
18:	9.8	→
19:	9.7	↙
20:	9.8	↓
<b>Serie</b>		<b>90.0</b>
<b>Total</b>		<b>184.0</b>

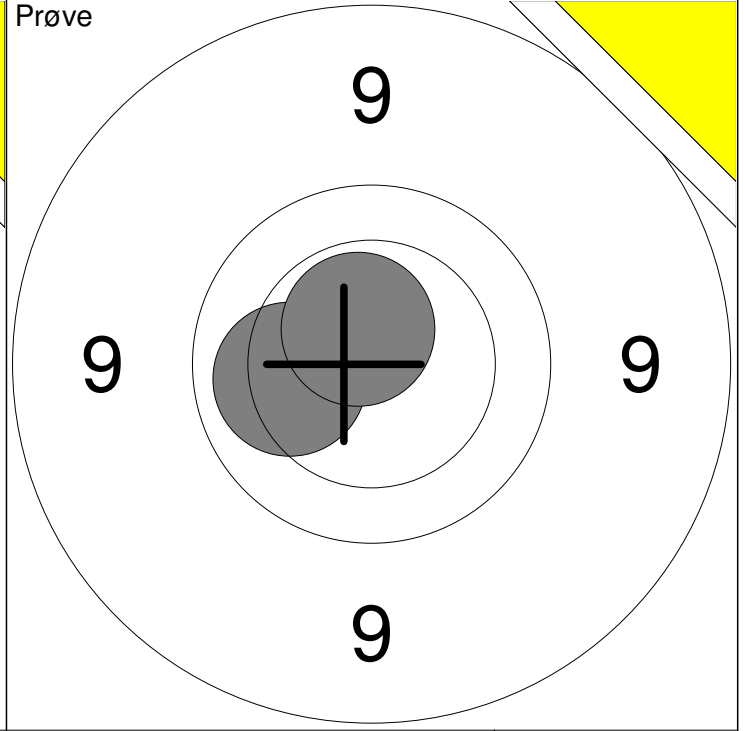
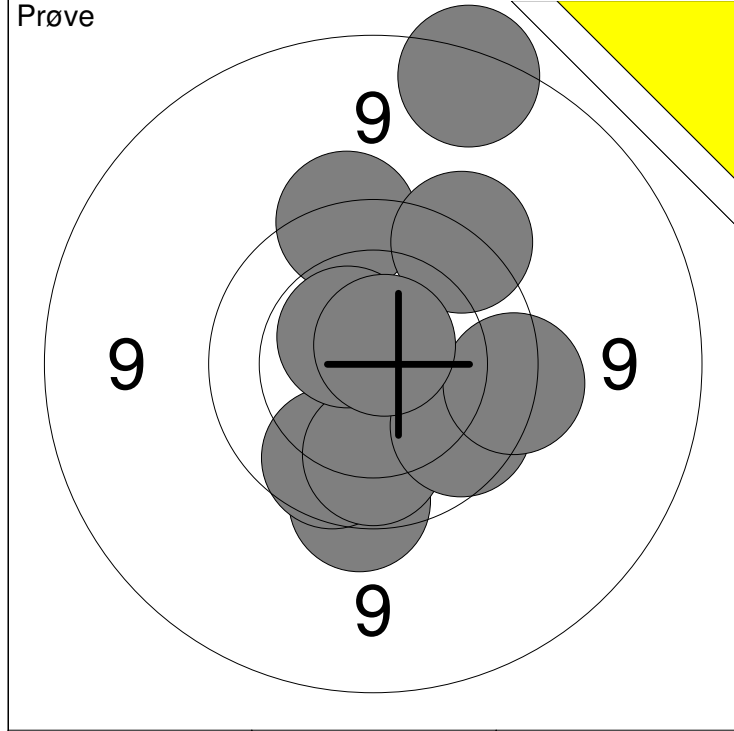

1: 9.6 ↑	6: 10.0 ↓	Serie	92
2: 9.6 ↗	7: 9.9 ↘		
3: 8.8 ↑	8: 9.7 →	Total	0
4: 9.7 ↓	9: 10.5x ↖		
5: 9.9 ↙	10: 10.7x ↗		

11: 10.1 ←	Serie	20
12: 10.6x ↖		
Total		0

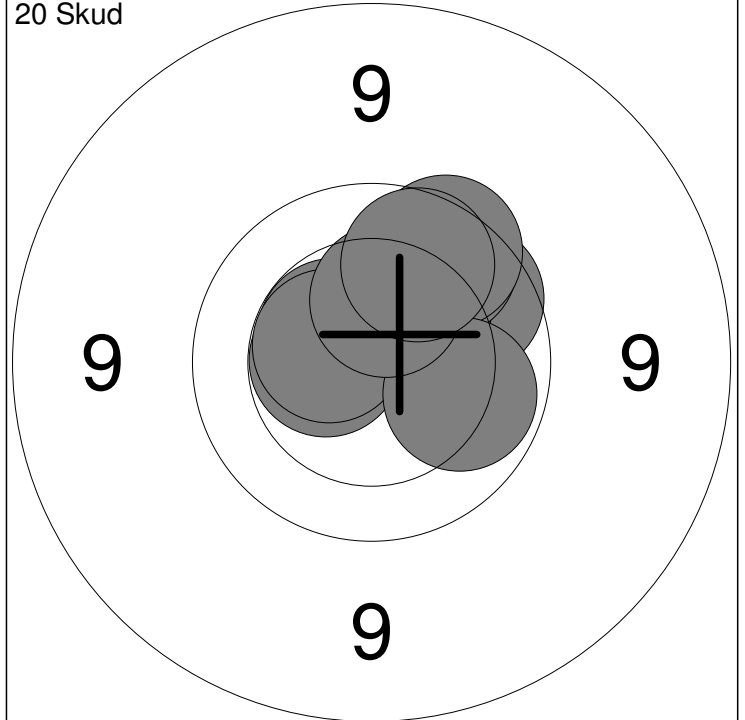
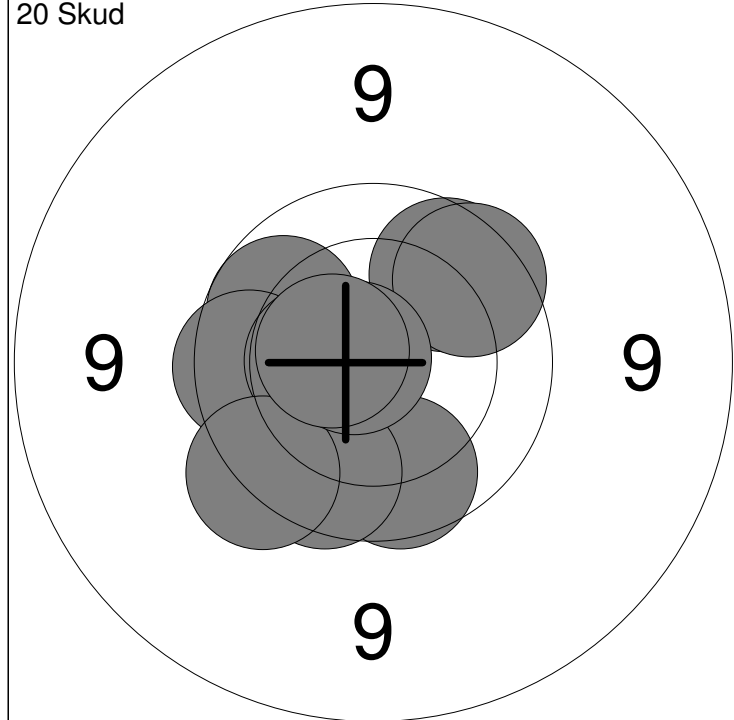

1: 9.9 ↗	6: 9.9 ↓	Serie	93
2: 9.9 ↖	7: 9.7 ↘		
3: 9.8 ←	8: 9.8 ↗	Total	93
4: 10.4 ←	9: 10.8x ←		
5: 9.9 ↓	10: 10.5x ←		

11: 9.9 ↗	16: 9.8 ↗	Serie	96
12: 10.3 ↗	17: 9.8 ↗		
13: 10.5x ←	18: 10.0 →	Total	189
14: 10.5x ↖	19: 10.3 ↑		
15: 10.5x ←	20: 9.9 ↗		

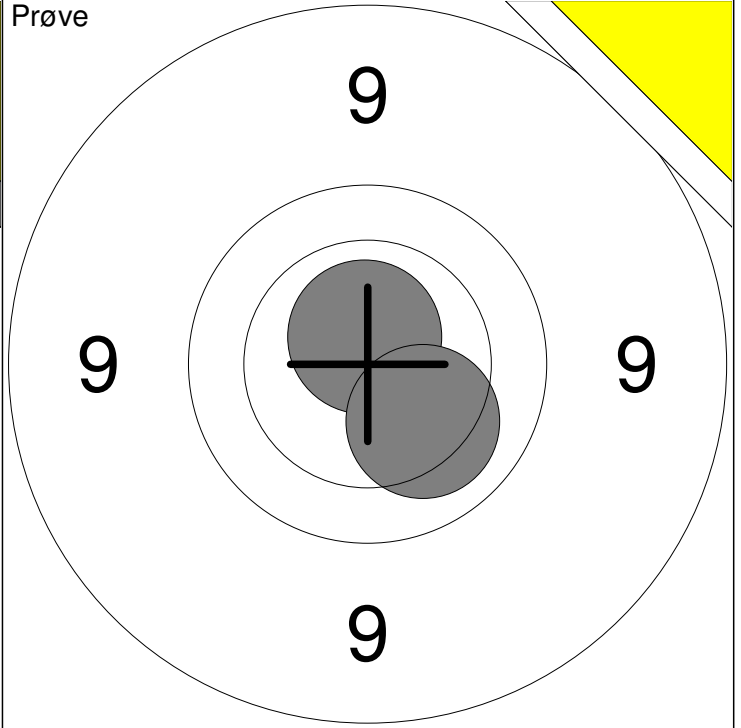
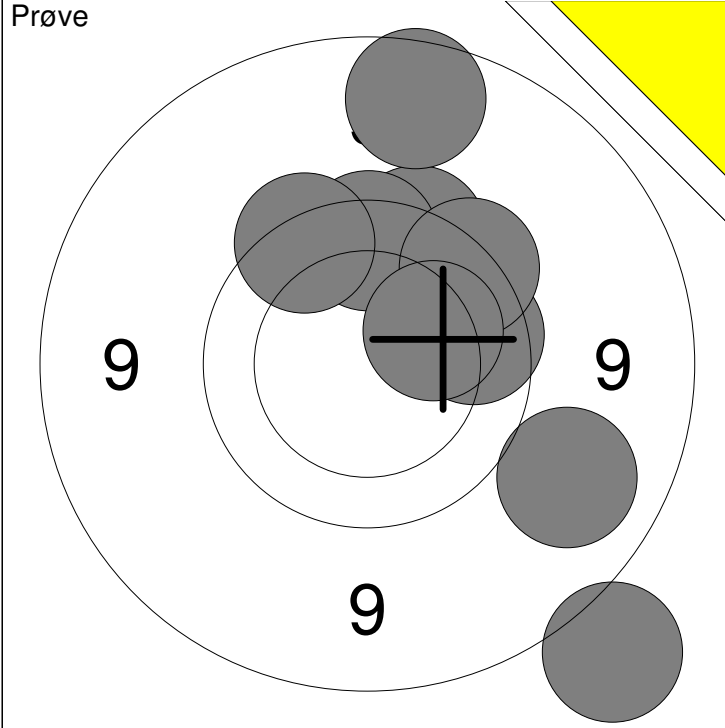

1: 8.5 ↘	6: 8.9 ↑	Serie	89
2: 9.8 →	7: 9.8 ↑		
3: 9.1 ↘	8: 9.7 ↗	Total	0
4: 9.8 →	9: 10.2 ↗		
5: 9.7 ↑	10: 9.7 ↖		

11: 10.7x ↑	Serie	20
12: 10.2 ↘		
Total		0

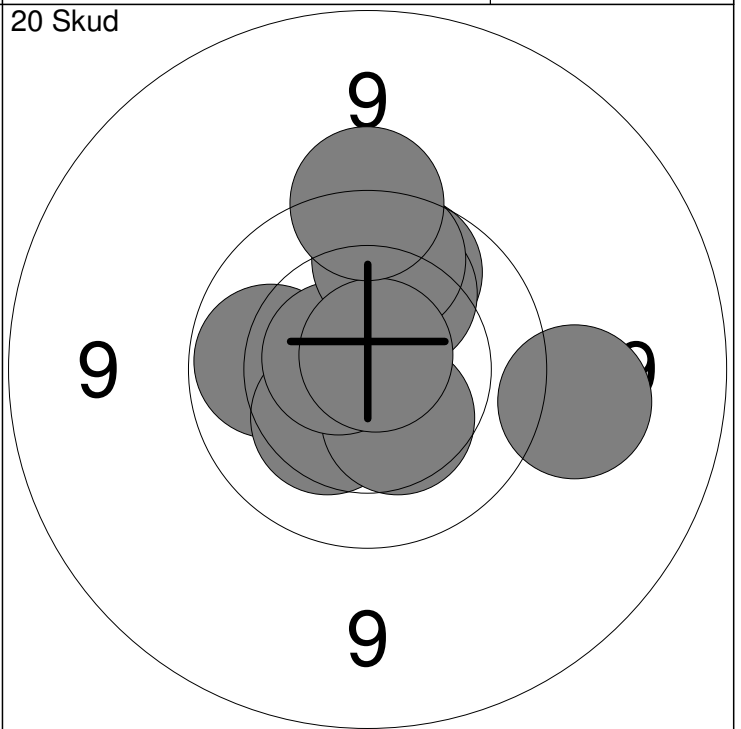
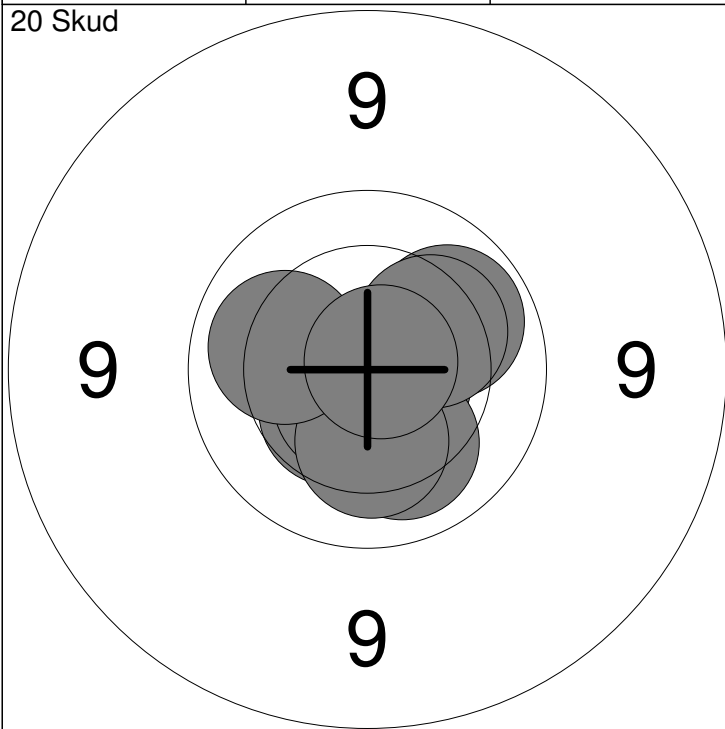

1: 10.5x ↓	6: 10.2 ↓	Serie	100
2: 10.0 →	7: 10.2 ↓		
3: 10.4 ↙	8: 10.1 ←	Total	100
4: 10.6x ↙	9: 10.2 ↗		
5: 10.7x →	10: 10.8x ↗		

11: 10.0 ←	16: 10.4 ↓	Serie	96
12: 9.9 ↑	17: 10.6x ↙		
13: 10.3 ↙	18: 9.9 ↑	Total	196
14: 9.3 →	19: 10.8x ↗		
15: 10.1 ↑	20: 9.6 ↑		

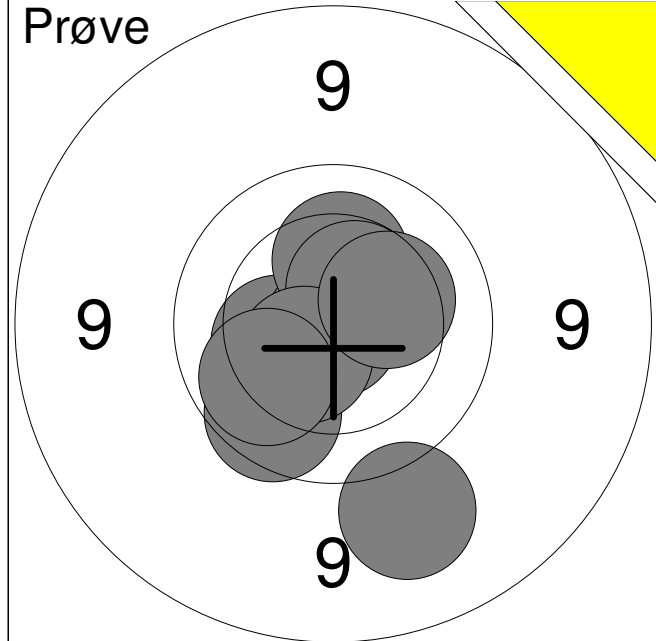

1:	9.3	↘
2:	10.3	←
3:	10.9x	↘
4:	10.2	↑
5:	9.8	↘
6:	10.5x	↗
7:	10.5	↘
8:	10.0	↘
9:	10.3	↗
<b>Serie</b>		<b>88.0</b>
<b>Total</b>		<b>0.0</b>

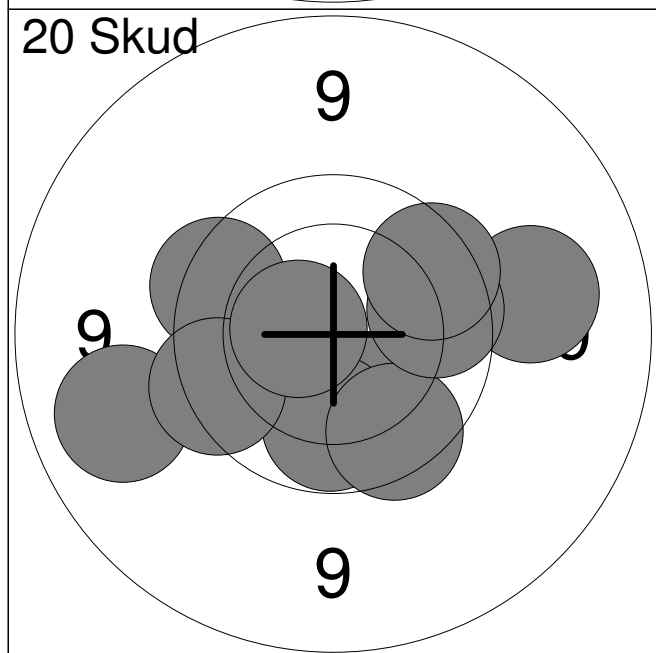

1:	10.3	↘
2:	10.0	↘
3:	9.7	←
4:	9.1	←
5:	9.8	↘
6:	9.3	→
7:	9.9	→
8:	9.7	←
9:	9.8	↗
10:	10.6x	←
<b>Serie</b>		<b>93.0</b>
<b>Total</b>		<b>93.0</b>

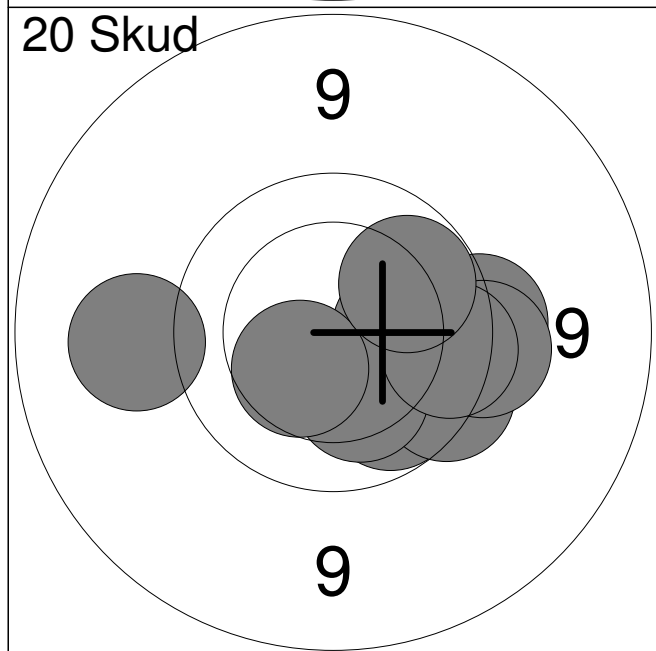

11:	10.0	↘
12:	9.3	←
13:	9.7	↘
14:	10.2	→
15:	9.6	→
16:	9.6	→
17:	10.2	↘
18:	10.4	↘
19:	9.8	→
20:	10.0	↗
<b>Serie</b>		<b>95.0</b>
<b>Total</b>		<b>188.0</b>



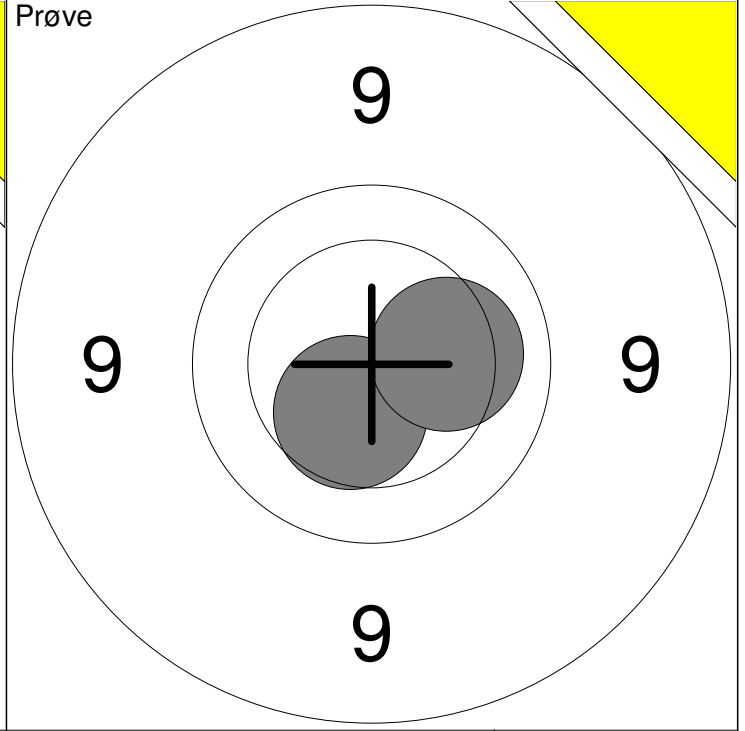
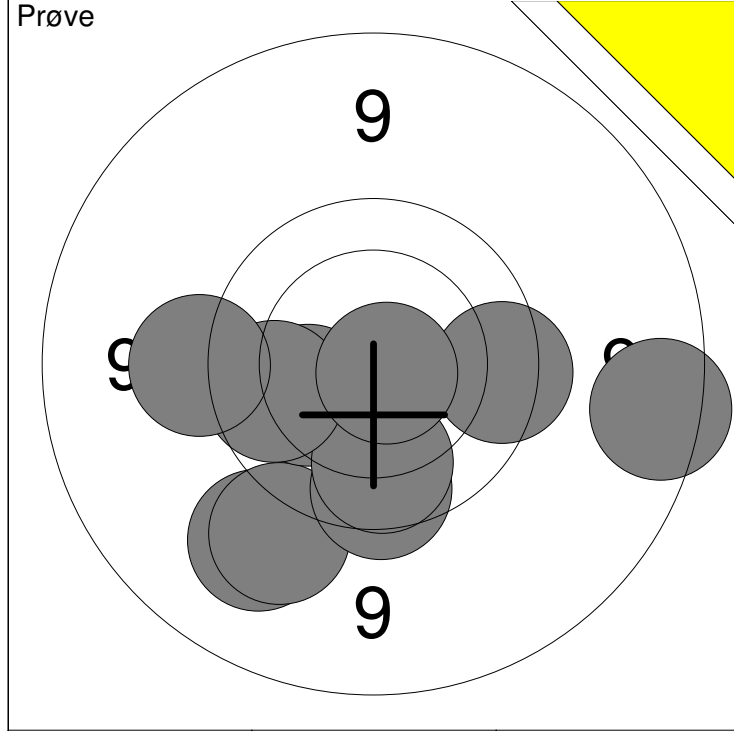

1: 8.8 →	6: 9.9 ↓	Serie	91
2: 9.2 ↙	7: 9.7 →		
3: 9.3 ↙	8: 9.9 ←	Total	0
4: 9.8 ↓	9: 10.8x ↘		
5: 10.2 ←	10: 9.5 ←		

11: 10.4 ↙	Serie	20
12: 10.2 →		
	Total	0

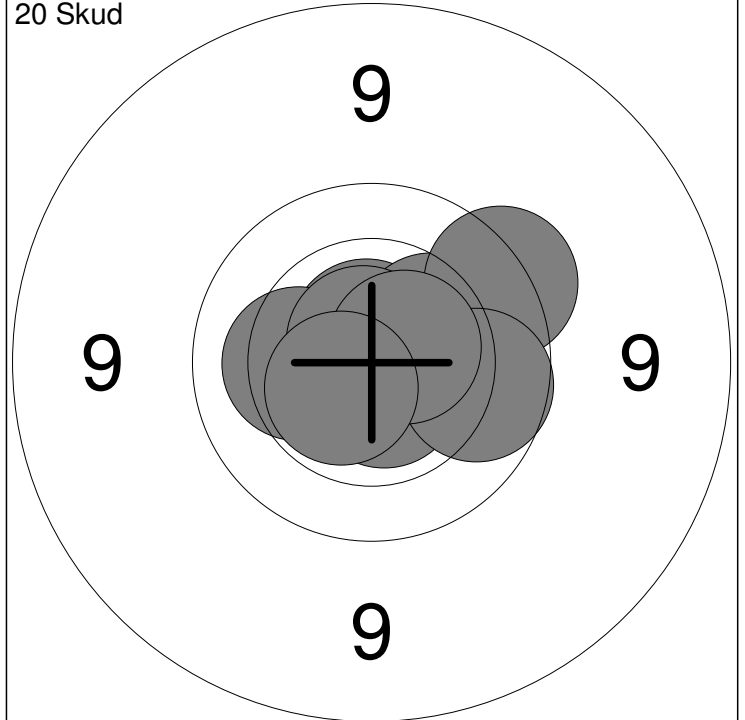
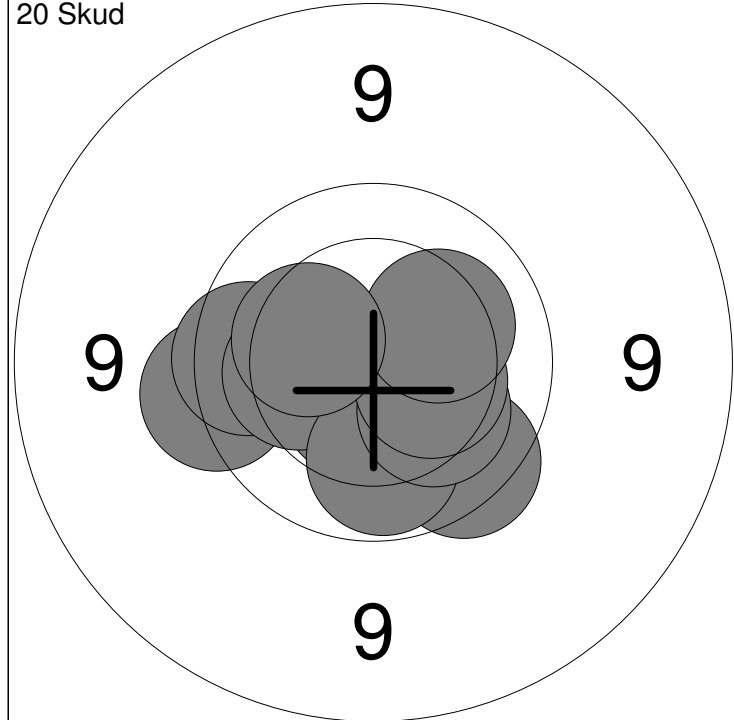

1: 9.6 ←	6: 10.0 ↓	Serie	97
2: 9.8 ←	7: 10.2 ↓		
3: 10.5x ↙	8: 10.4 →	Total	97
4: 9.8 ↙	9: 10.2 ↗		
5: 10.2 ←	10: 10.3 ←		

11: 10.7x ↗	16: 9.9 →	Serie	98
12: 10.7x ↑	17: 10.2 ←		
13: 10.6x ↓	18: 10.7x ↗	Total	195
14: 10.3 ↗	19: 10.6x ↗		
15: 9.7 ↗	20: 10.6x ↙		

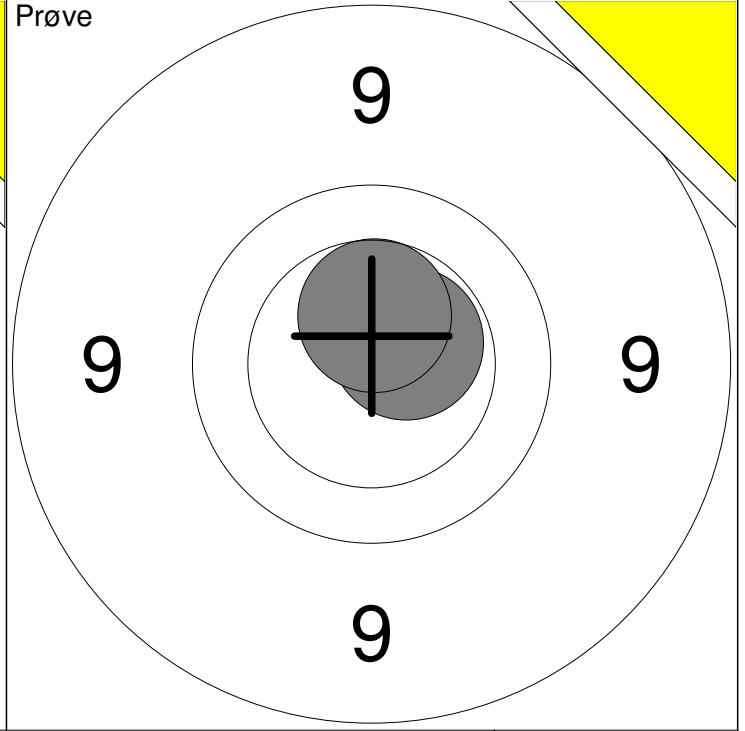
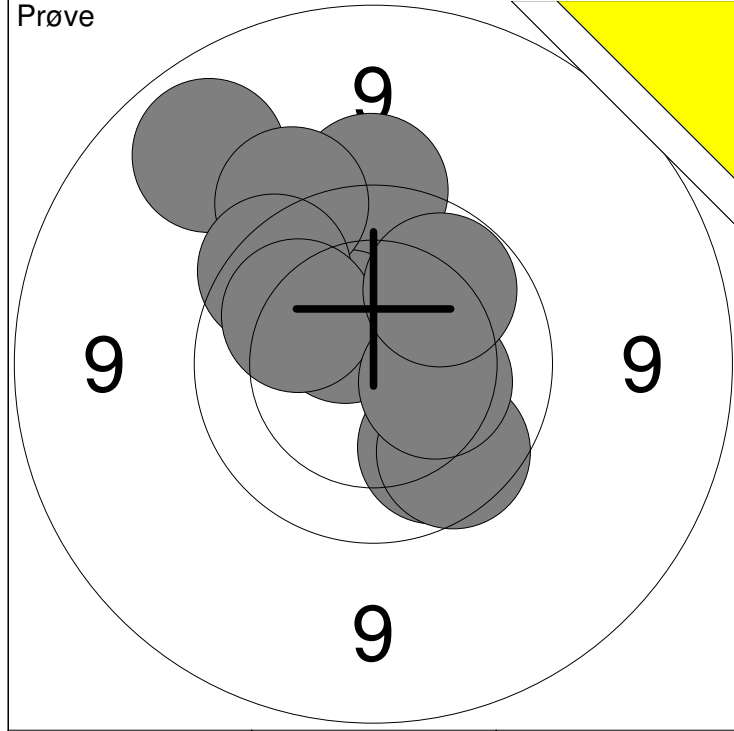

1: 9.6	↑	6: 10.1	↖	Serie	94
2: 9.0	↗	7: 9.9	↘		
3: 10.5x	↗	8: 9.9	↘	Total	0
4: 9.5	↗	9: 10.3	↘		
5: 9.8	↗	10: 10.0	↗		

11: 10.5x	↗	Serie	20
12: 10.5	↑		
		Total	0

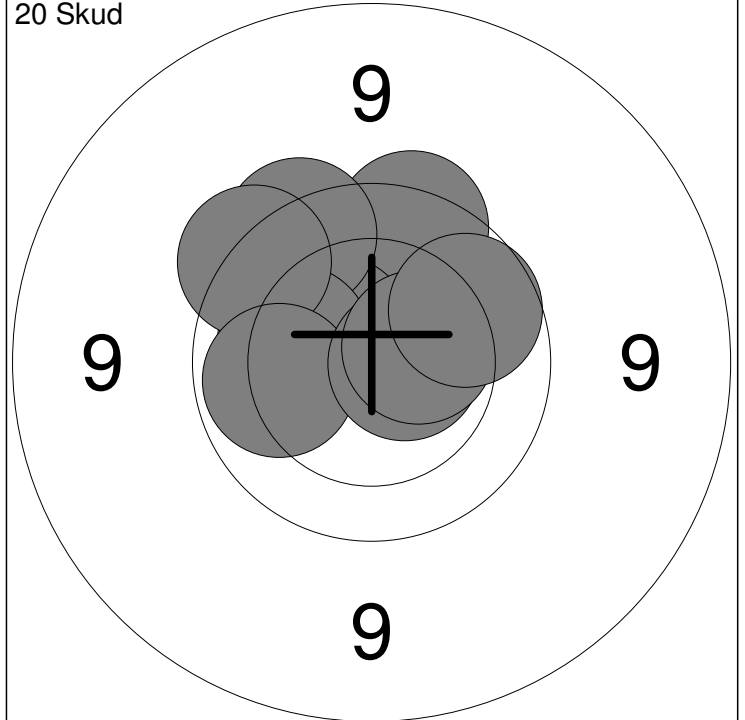
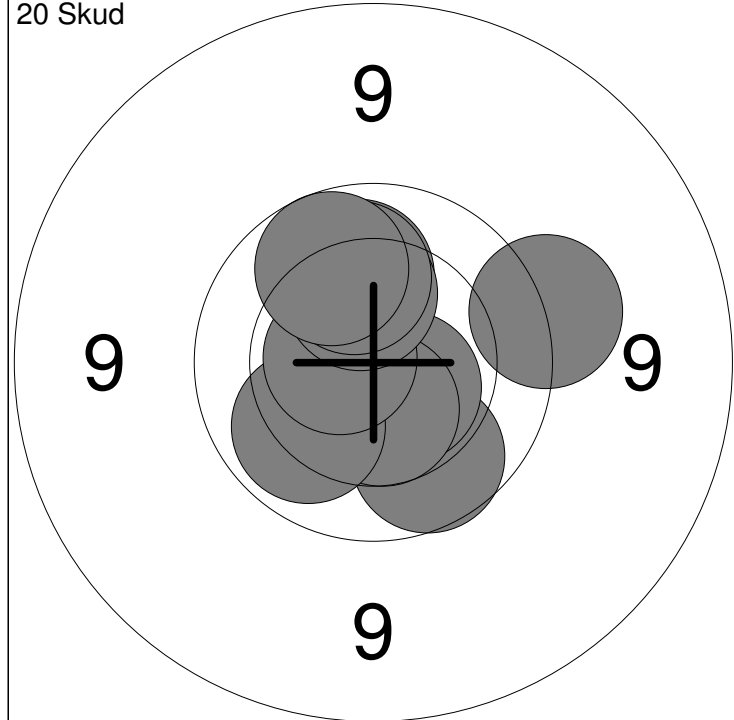

1: 9.9	↘	6: 10.1	↑	Serie	97
2: 9.5	↗	7: 10.6x	↖		
3: 10.6x	↘	8: 10.3	↑	Total	97
4: 10.5	↘	9: 10.1	↑		
5: 10.1	↖	10: 9.9	↗		

11: 10.5x	↑	16: 9.7	↖	Serie	96
12: 9.7	↑	17: 10.0	↖		
13: 10.5	↖	18: 10.6x	↗	Total	193
14: 9.7	↗	19: 10.5	↗		
15: 10.2	↖	20: 9.9	↗		

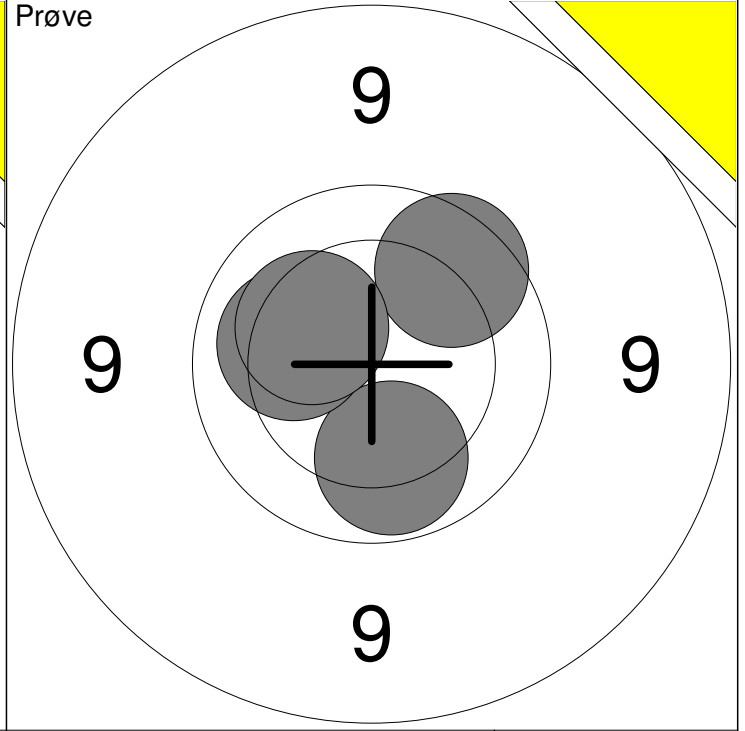
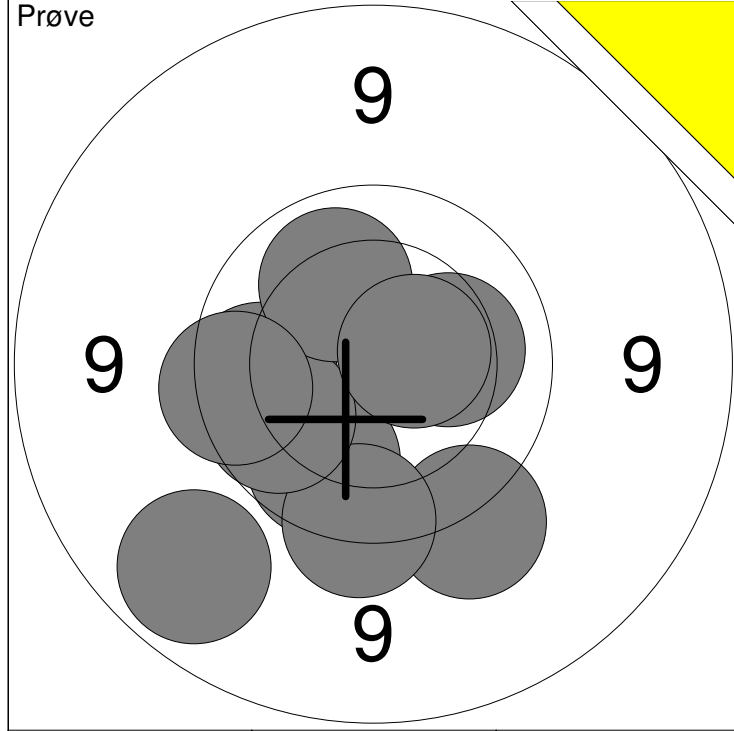

1: 9.5	2: 9.0	3: 9.9	4: 9.6	5: 9.9	6: 9.9	7: 10.2	8: 10.1	9: 9.7	10: 10.5x		
↓	↙	↓	↓	←	←	→	↗	←	→	Serie	93
										Total	0

11: 10.0	12: 10.2	13: 9.8	14: 10.3								
↓	←	↗	↖								
										Serie	39
										Total	0

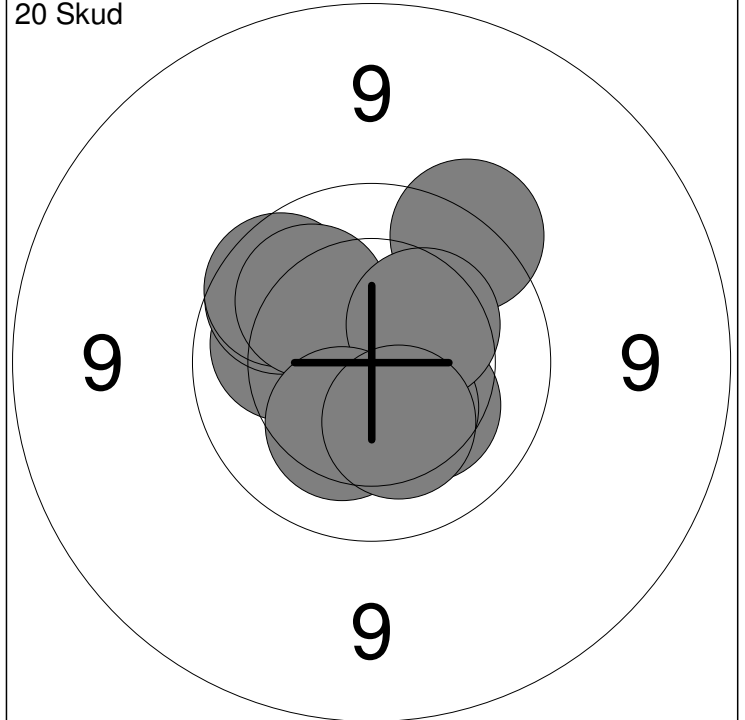
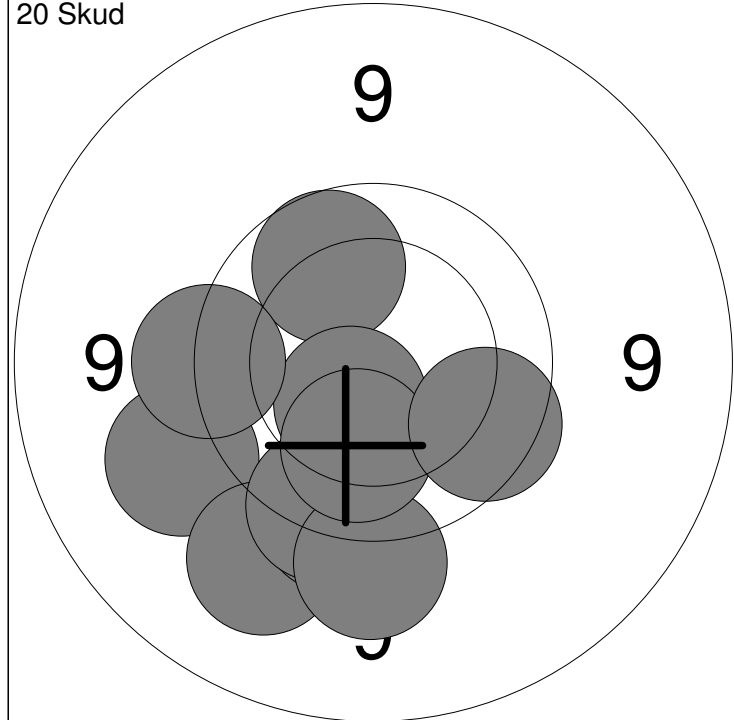

1: 9.9	2: 9.3	3: 10.5	4: 9.3	5: 9.6	6: 9.7	7: 9.4	8: 10.1	9: 9.8	10: 9.6		
↗	↖	↓	↓	↓	↓	↓	↘	↘	←	Serie	92
										Total	92

11: 10.1	12: 10.3	13: 9.9	14: 9.9	15: 9.6	16: 10.4	17: 10.1	18: 10.3	19: 10.3	20: 10.3		
←	↓	↗	↗	↗	↓	↗	↗	↓	↓	Serie	97
										Total	189

Hold	Skive	Sune Grøn Bendixen																																					
81	11	AAS	Hjørring Skytteforening																																				
02.02.2017		NM 2017 ungdom riffel	Aalborg Skyttekreds																																				
Prøve		<table border="1"> <tr><td>1:</td><td>10.2</td><td>→</td></tr> <tr><td>2:</td><td>10.2</td><td>↓</td></tr> <tr><td>3:</td><td>10.1</td><td>↙</td></tr> <tr><td>4:</td><td>10.4</td><td>↘</td></tr> <tr><td>5:</td><td>10.6x</td><td>↓</td></tr> <tr><td>6:</td><td>10.6x</td><td>→</td></tr> <tr><td colspan="2">Serie</td><td>60.0</td></tr> <tr><td colspan="2">Total</td><td>0.0</td></tr> </table>		1:	10.2	→	2:	10.2	↓	3:	10.1	↙	4:	10.4	↘	5:	10.6x	↓	6:	10.6x	→	Serie		60.0	Total		0.0												
1:	10.2	→																																					
2:	10.2	↓																																					
3:	10.1	↙																																					
4:	10.4	↘																																					
5:	10.6x	↓																																					
6:	10.6x	→																																					
Serie		60.0																																					
Total		0.0																																					
20 Skud		<table border="1"> <tr><td>1:</td><td>10.2</td><td>→</td></tr> <tr><td>2:</td><td>10.0</td><td>↖</td></tr> <tr><td>3:</td><td>10.7x</td><td>↙</td></tr> <tr><td>4:</td><td>10.6x</td><td>↗</td></tr> <tr><td>5:</td><td>10.7x</td><td>→</td></tr> <tr><td>6:</td><td>10.6x</td><td>↖</td></tr> <tr><td>7:</td><td>10.6x</td><td>↗</td></tr> <tr><td>8:</td><td>10.6x</td><td>→</td></tr> <tr><td>9:</td><td>10.6x</td><td>↓</td></tr> <tr><td>10:</td><td>10.6x</td><td>↑</td></tr> <tr><td colspan="2">Serie</td><td>100.0</td></tr> <tr><td colspan="2">Total</td><td>100.0</td></tr> </table>		1:	10.2	→	2:	10.0	↖	3:	10.7x	↙	4:	10.6x	↗	5:	10.7x	→	6:	10.6x	↖	7:	10.6x	↗	8:	10.6x	→	9:	10.6x	↓	10:	10.6x	↑	Serie		100.0	Total		100.0
1:	10.2	→																																					
2:	10.0	↖																																					
3:	10.7x	↙																																					
4:	10.6x	↗																																					
5:	10.7x	→																																					
6:	10.6x	↖																																					
7:	10.6x	↗																																					
8:	10.6x	→																																					
9:	10.6x	↓																																					
10:	10.6x	↑																																					
Serie		100.0																																					
Total		100.0																																					
20 Skud		<table border="1"> <tr><td>11:</td><td>10.7x</td><td>↙</td></tr> <tr><td>12:</td><td>10.6x</td><td>↗</td></tr> <tr><td>13:</td><td>10.2</td><td>↖</td></tr> <tr><td>14:</td><td>9.9</td><td>↖</td></tr> <tr><td>15:</td><td>10.7x</td><td>↑</td></tr> <tr><td>16:</td><td>10.4</td><td>↗</td></tr> <tr><td>17:</td><td>10.0</td><td>→</td></tr> <tr><td>18:</td><td>10.3</td><td>↗</td></tr> <tr><td>19:</td><td>10.8x</td><td>→</td></tr> <tr><td>20:</td><td>10.6x</td><td>↖</td></tr> <tr><td colspan="2">Serie</td><td>99.0</td></tr> <tr><td colspan="2">Total</td><td>199.0</td></tr> </table>		11:	10.7x	↙	12:	10.6x	↗	13:	10.2	↖	14:	9.9	↖	15:	10.7x	↑	16:	10.4	↗	17:	10.0	→	18:	10.3	↗	19:	10.8x	→	20:	10.6x	↖	Serie		99.0	Total		199.0
11:	10.7x	↙																																					
12:	10.6x	↗																																					
13:	10.2	↖																																					
14:	9.9	↖																																					
15:	10.7x	↑																																					
16:	10.4	↗																																					
17:	10.0	→																																					
18:	10.3	↗																																					
19:	10.8x	→																																					
20:	10.6x	↖																																					
Serie		99.0																																					
Total		199.0																																					

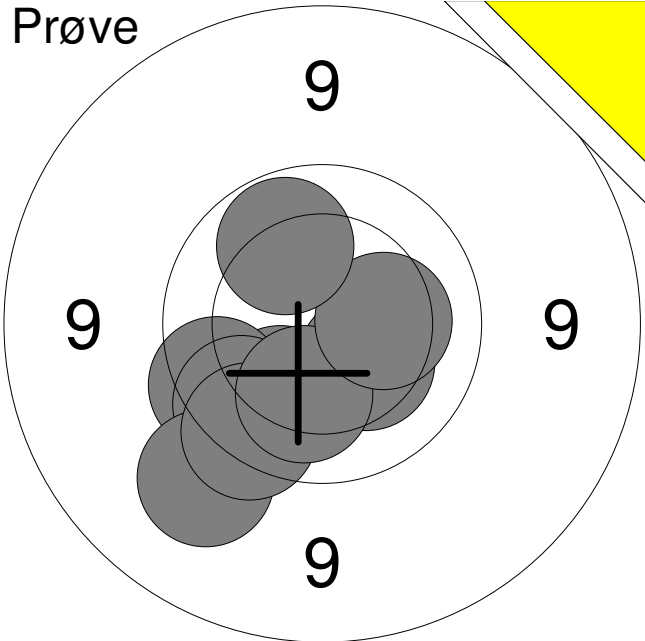
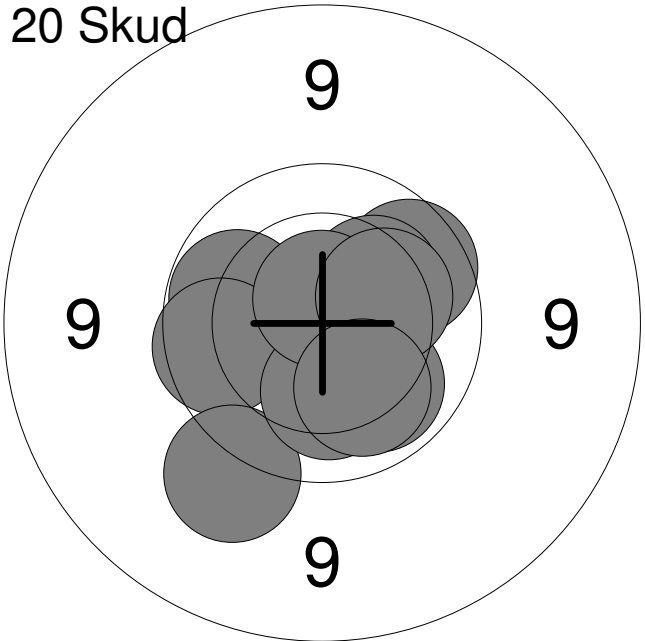
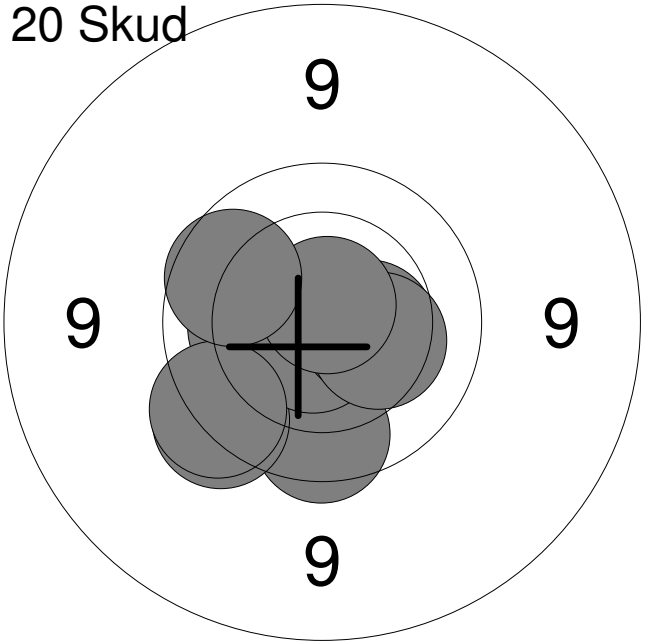
Hold <b>81</b>	Skive <b>12</b>	<b>Oscar Alon</b>		
AAS		Hjørring Skytteforening		J2
02.02.2017		NM 2017 ungdom riffel		Aalborg Skyttekreds
<b>Prøve</b>				
		1:	10.0	↘
		2:	9.8	↙
		3:	9.8	↘
		4:	9.3	↘
		5:	9.7	↘
		6:	10.3	↘
		7:	10.1	↘
		8:	10.3	→
		9:	10.0	↗
		<b>Serie</b>		<b>86.0</b>
		<b>Total</b>		<b>0.0</b>
<b>20 Skud</b>				
		1:	10.0	↙
		2:	9.9	↙
		3:	9.4	↘
		4:	9.9	↗
		5:	10.2	↘
		6:	10.1	↘
		7:	10.2	↗
		8:	10.7x	↑
		9:	10.2	↗
		10:	10.1	↘
		<b>Serie</b>		<b>97.0</b>
		<b>Total</b>		<b>97.0</b>
<b>20 Skud</b>				
		11:	9.8	↓
		12:	9.6	↙
		13:	10.8x	↙
		14:	10.2	↙
		15:	10.7x	↘
		16:	9.7	↙
		17:	10.4	→
		18:	10.3	↗
		19:	10.7x	↑
		20:	9.9	↙
		<b>Serie</b>		<b>96.0</b>
		<b>Total</b>		<b>193.0</b>

<b>Prøve</b> 	1:	9.6	→
	2:	9.9	↘
	3:	10.3	↘
	4:	9.8	↘
	5:	10.3	→
	6:	9.6	↘
	7:	9.8	↘
	8:	10.9x	↘
	9:	10.1	↘
	<b>Serie</b>		<b>85.0</b>
<b>Total</b>		<b>0.0</b>	

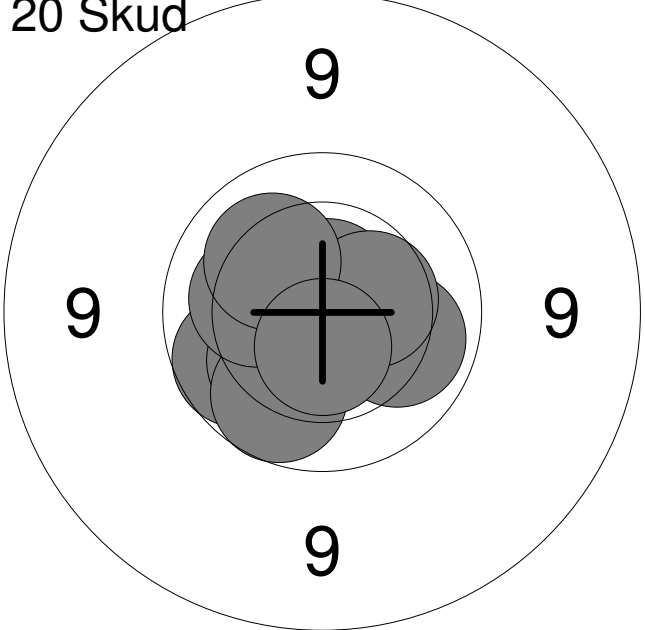
<b>20 Skud</b> 	1:	9.9	↙
	2:	10.2	↙
	3:	10.3	↗
	4:	9.9	↘
	5:	10.2	↙
	6:	10.1	↗
	7:	10.7x	↗
	8:	10.4	→
	9:	10.2	↗
	10:	10.6x	↓
<b>Serie</b>		<b>98.0</b>	
<b>Total</b>		<b>98.0</b>	

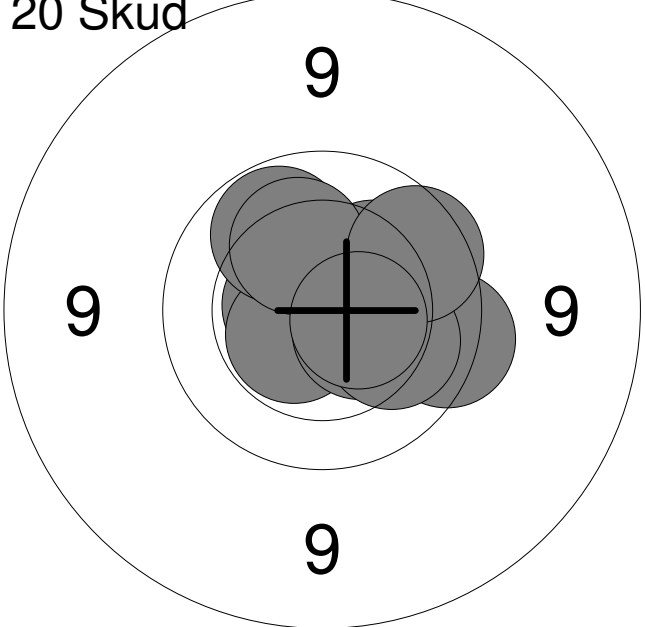
<b>20 Skud</b> 	11:	10.2	↗
	12:	9.7	→
	13:	10.6x	↙
	14:	10.5x	↘
	15:	10.5	↘
	16:	10.1	↘
	17:	10.0	↗
	18:	10.2	↗
	19:	9.8	↗
	20:	10.5x	→
<b>Serie</b>		<b>98.0</b>	
<b>Total</b>		<b>196.0</b>	

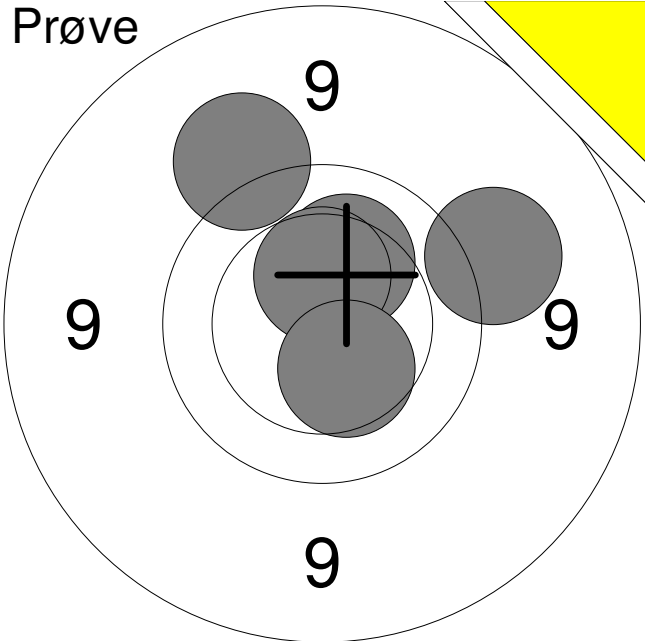
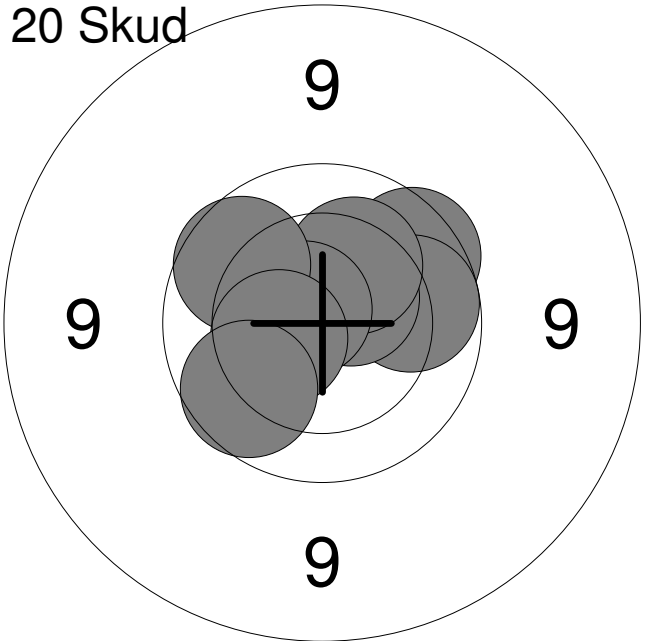
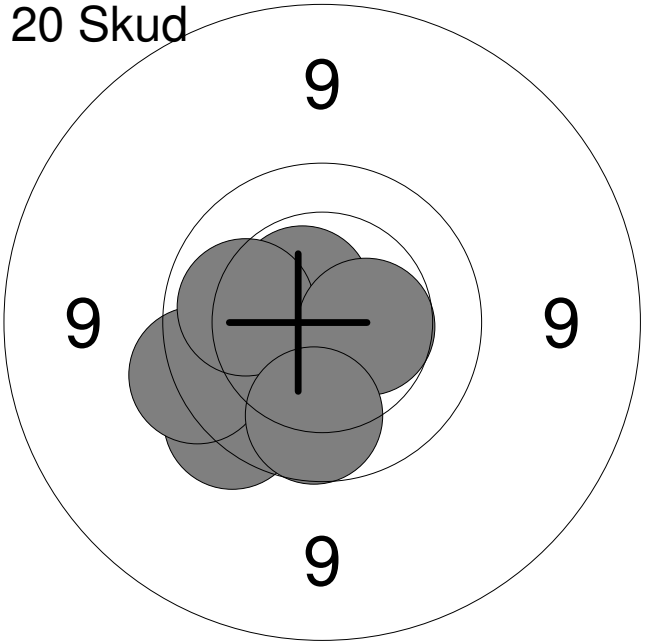
Hold	Skive	William Larsen	
82	2	AAS	Skf. Kimbrerne
		BK3	
02.02.2017	NM 2017 ungdom riffel	Aalborg Skyttekreds	
Prøve		1: 9.4	↖
		2: 9.4	→
		3: 10.2	↗
		4: 10.4	↑
		5: 10.4	↘
		<b>Serie</b>	<b>48.0</b>
		<b>Total</b>	<b>0.0</b>
20 Skud		1: 9.8	↗
		2: 9.9	→
		3: 10.5	↖
		4: 10.5x	↗
		5: 10.5	↖
		6: 10.2	↗
		7: 10.7x	↖
		8: 9.9	↖
		9: 10.4	↖
		10: 9.9	↘
		<b>Serie</b>	<b>96.0</b>
		<b>Total</b>	<b>96.0</b>
20 Skud		11: 10.5	↖
		12: 10.3	↖
		13: 10.7x	↖
		14: 10.1	↖
		15: 9.7	↘
		16: 9.7	↖
		17: 10.6x	↗
		18: 10.1	↖
		19: 10.5	→
		20: 9.9	↘
		<b>Serie</b>	<b>97.0</b>
		<b>Total</b>	<b>193.0</b>

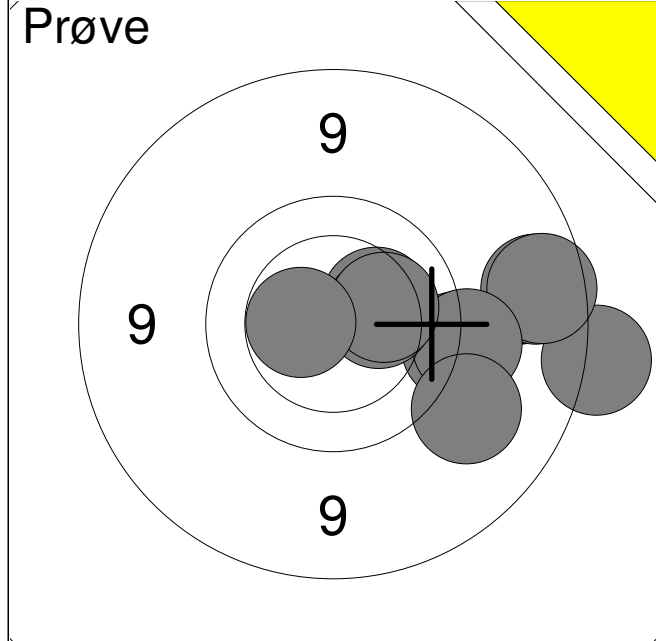

1:	8.6	→
2:	8.9	→
3:	8.9	→
4:	9.5	→
5:	9.5	→
6:	9.3	↘
7:	10.3	↗
8:	10.3	→
9:	10.2	↗
10:	10.5x	←
<b>Serie</b>		<b>91.0</b>
<b>Total</b>		<b>0.0</b>

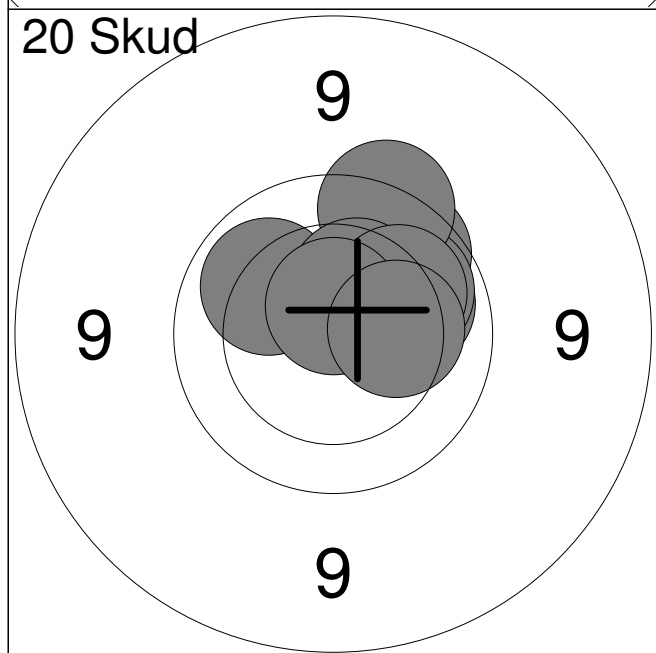

1:	9.9	↗
2:	10.1	↖
3:	10.1	→
4:	10.0	↗
5:	10.4	↗
6:	9.7	↑
7:	10.4	↑
8:	10.1	↗
9:	10.6x	↑
10:	10.3	→
<b>Serie</b>		<b>98.0</b>
<b>Total</b>		<b>98.0</b>

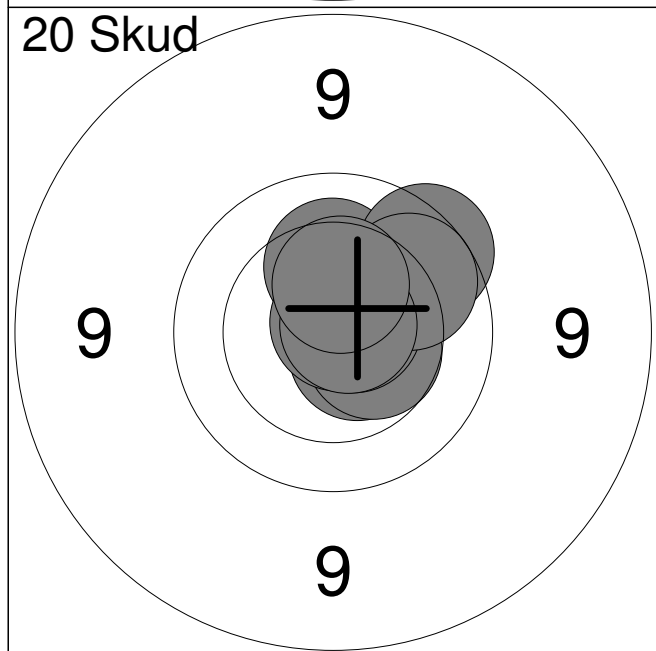

11:	10.6x	↘
12:	10.5	↘
13:	10.7x	→
14:	10.5x	↗
15:	10.2	↑
16:	9.7	↗
17:	10.8x	↗
18:	9.9	↗
19:	10.8x	→
20:	10.4	↑
<b>Serie</b>		<b>98.0</b>
<b>Total</b>		<b>196.0</b>

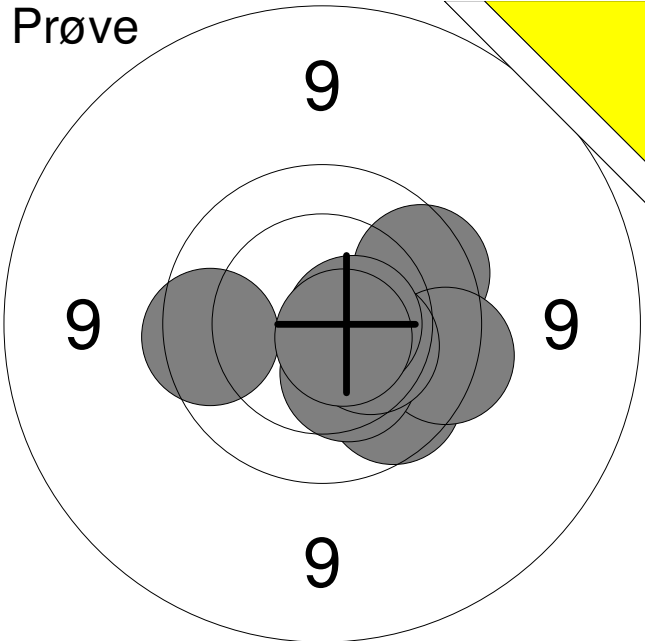
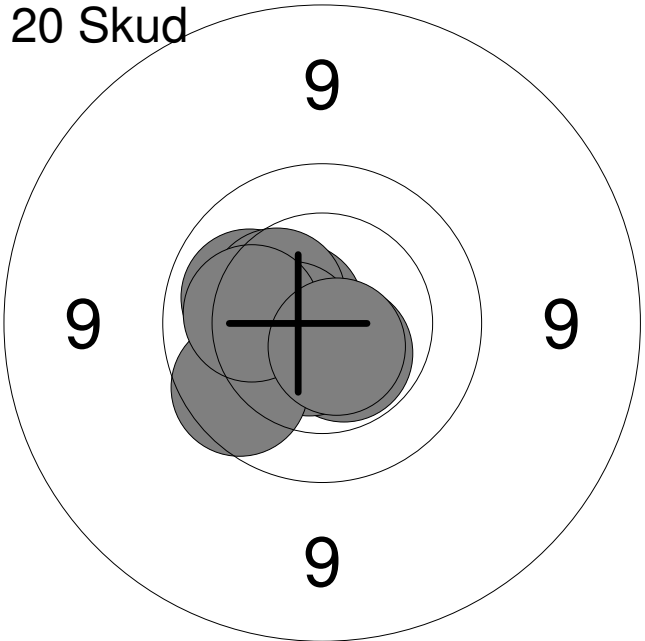
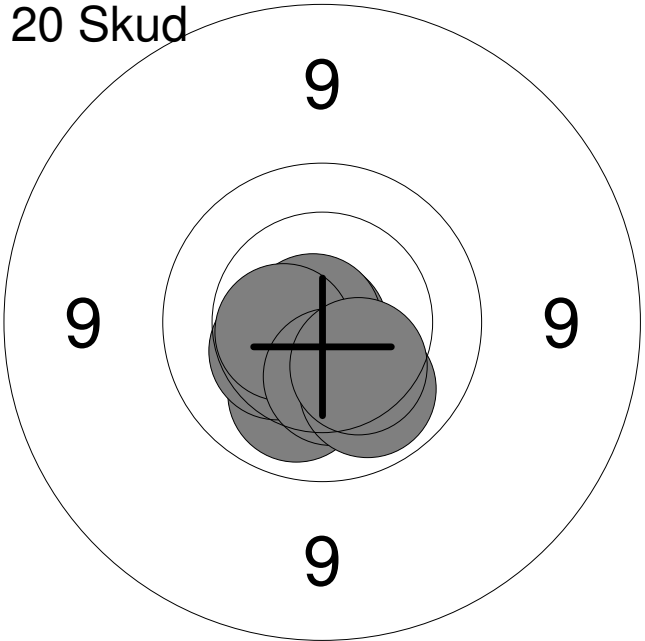

Hold	Skive		
82	9	David Rønn	
AAS		Aalborg Skyttekreds	J2
02.02.2017	NM 2017 ungdom riffel	Aalborg Skyttekreds	
Prøve		1: 9.9 ↘	
		2: 10.2 →	
		3: 9.8 ←	
		4: 9.8 ↗	
		5: 9.7 ↘	
		6: 10.3 ↘	
		7: 10.4 ↘	
		8: 10.6x →	
		9: 10.7x ↘	
		Serie	86.0
		Total	0.0
20 Skud		1: 10.5x ↘	
		2: 10.1 ←	
		3: 10.6x ↗	
		4: 10.7x ←	
		5: 10.6x ↘	
		6: 10.4 ↗	
		7: 10.6x ←	
		8: 9.9 ←	
		9: 10.2 ←	
		10: 10.6x ↘	
		Serie	99.0
		Total	99.0
20 Skud		11: 10.6x ↙	
		12: 10.4 ↘	
		13: 10.1 ↘	
		14: 10.4 ↙	
		15: 10.9x ↘	
		16: 10.8x ←	
		17: 10.5x ←	
		18: 10.3 ↘	
		19: 10.1 ↘	
		20: 10.3 ↘	
		Serie	100.0
		Total	199.0

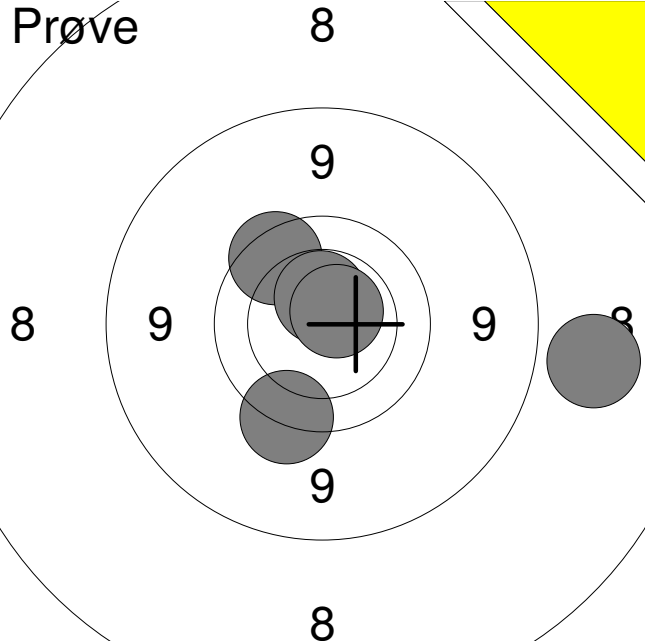
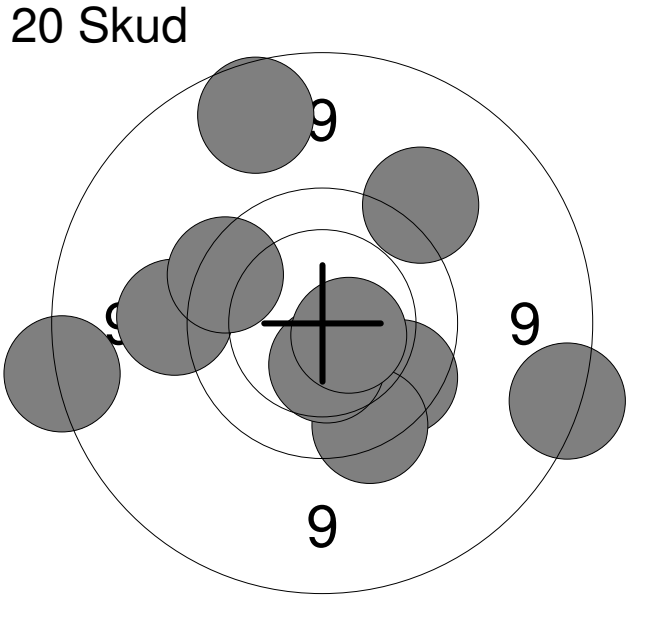
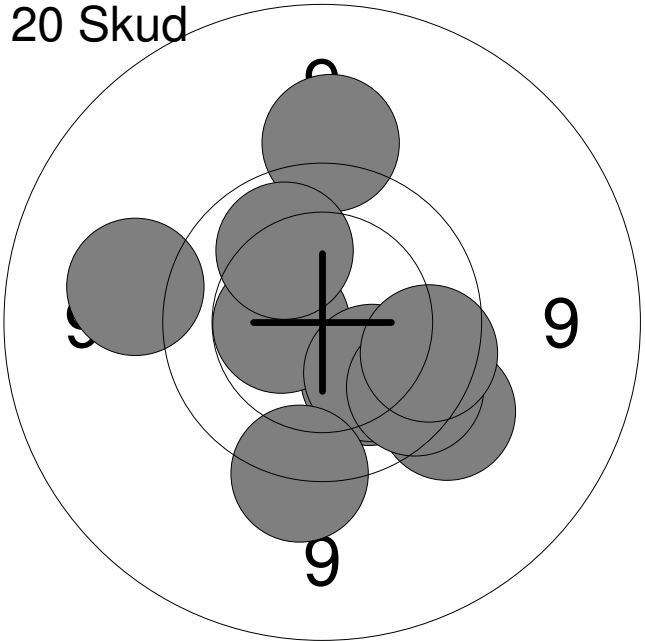
Hold <b>82</b>	Skive <b>11</b>	<b>Mads Rømer</b>	
AAS		Hjørring Skytteforening	MB3
02.02.2017	NM 2017 ungdom riffel		Aalborg Skyttekreds
<b>Prøve</b>	<b>8</b>		1: 8.3 → 2: 9.8 ↗ 3: 9.6 ↓ 4: 10.5x ↑ 5: 10.6x ↗
		<b>Serie</b>	<b>46.0</b>
		<b>Total</b>	<b>0.0</b>
<b>20 Skud</b>			1: 8.7 → 2: 8.7 ← 3: 9.4 ← 4: 9.8 ↘ 5: 9.7 ↘ 6: 10.4 ↓ 7: 10.6x ↘ 8: 9.7 ↗ 9: 9.4 ↗ 10: 8.9 ↑
		<b>Serie</b>	<b>89.0</b>
		<b>Total</b>	<b>89.0</b>
<b>20 Skud</b>			11: 9.4 ↑ 12: 9.3 ← 13: 9.6 ↘ 14: 10.2 ↘ 15: 10.5x ← 16: 10.1 ↗ 17: 10.2 ↘ 18: 9.8 ↘ 19: 9.6 ↓ 20: 9.8 →
		<b>Serie</b>	<b>94.0</b>
		<b>Total</b>	<b>183.0</b>

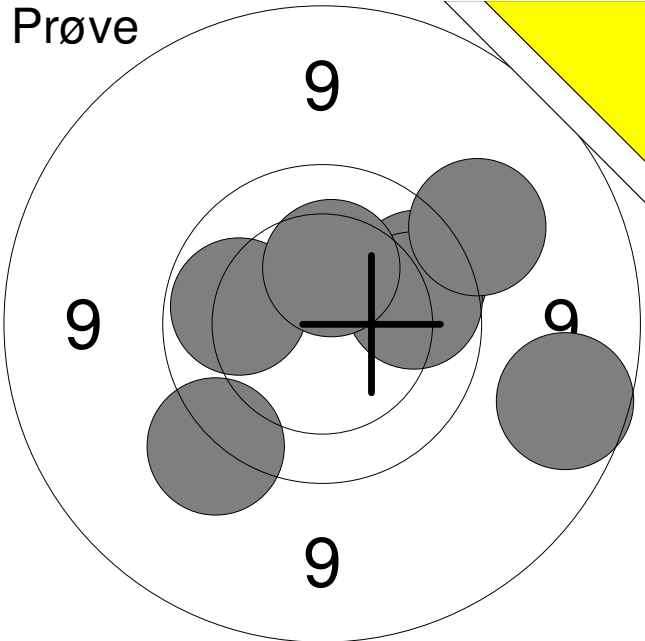
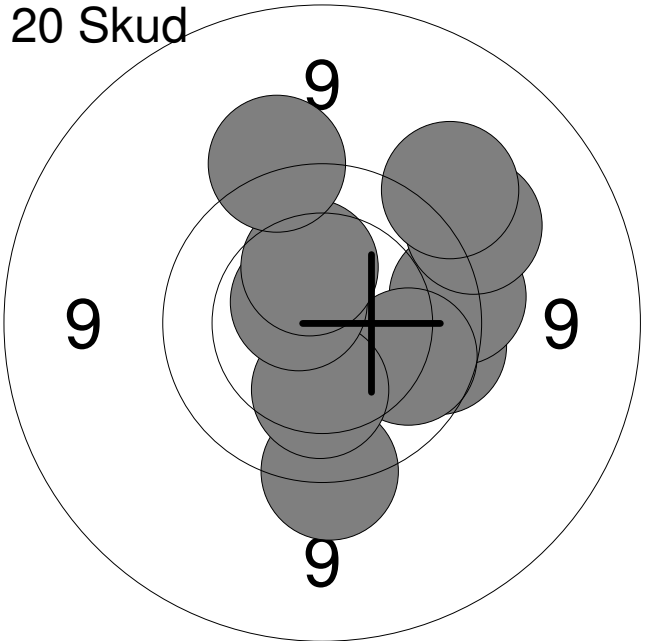
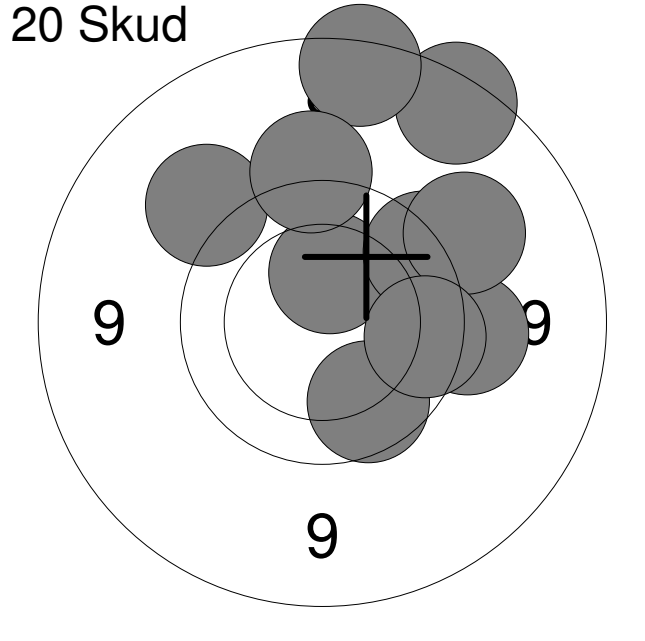
Hold <b>82</b>	Skive <b>12</b>	<b>Martin Axelgaard</b>		
AAS		Hjørring Skytteforening		MB3
02.02.2017		NM 2017 ungdom riffel		Aalborg Skyttekreds
<b>Prøve</b>				
		1:	9.5	↙
		2:	10.0	←
		3:	9.8	↗
		4:	8.9	→
		5:	9.9	↗
		6:	9.4	↗
		7:	10.3	↑
		<b>Serie</b>		<b>64.0</b>
		<b>Total</b>		<b>0.0</b>
<b>20 Skud</b>				
		1:	9.8	→
		2:	9.7	→
		3:	9.9	↘
		4:	9.6	↓
		5:	10.2	↓
		6:	9.4	↗
		7:	9.4	↗
		8:	10.6x	↗
		9:	10.3	↑
		10:	9.5	↑
		<b>Serie</b>		<b>93.0</b>
		<b>Total</b>		<b>93.0</b>
<b>20 Skud</b>				
		11:	9.9	↘
		12:	9.4	↗
		13:	8.8	↗
		14:	9.5	→
		15:	10.3	↑
		16:	9.6	↗
		17:	9.3	↗
		18:	9.8	→
		19:	8.8	↑
		20:	9.5	↑
		<b>Serie</b>		<b>89.0</b>
		<b>Total</b>		<b>182.0</b>

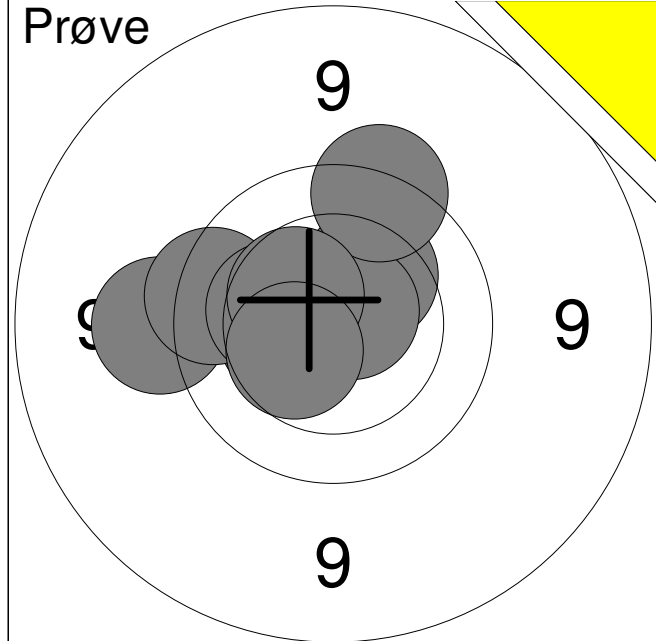

1:	10.3	↗
2:	10.4	←
3:	9.4	←
4:	9.7	←
5:	10.7x	↗
6:	10.3	←
7:	9.6	↗
8:	10.4	↖
9:	10.4	↙
<b>Serie</b>		<b>87.0</b>
<b>Total</b>		<b>0.0</b>

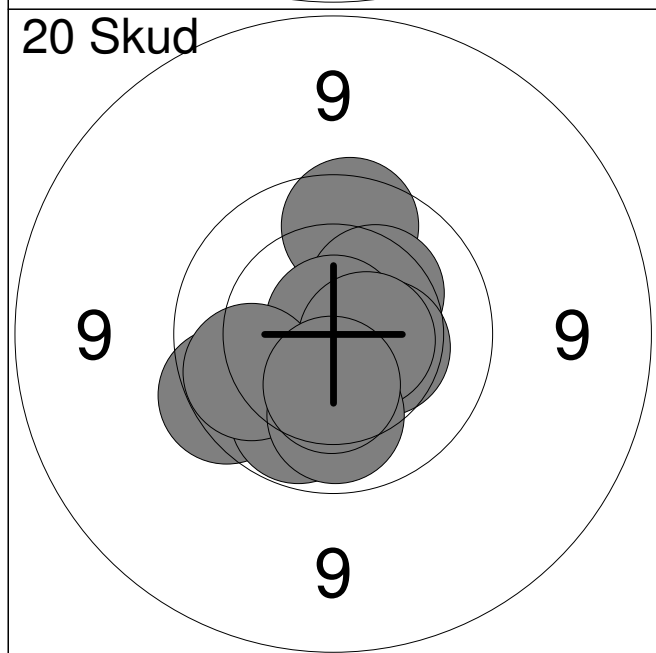

1:	9.8	↑
2:	9.7	↙
3:	10.3	↗
4:	10.4	→
5:	10.8x	↑
6:	10.6x	→
7:	10.0	↓
8:	10.0	↙
9:	10.1	↓
10:	10.4	↓
<b>Serie</b>		<b>98.0</b>
<b>Total</b>		<b>98.0</b>

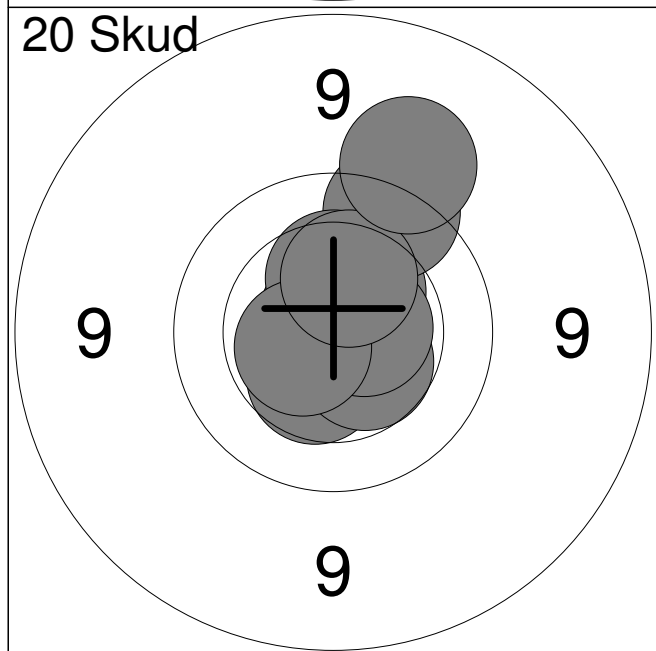

11:	10.8x	↗
12:	10.4	↓
13:	10.4	↗
14:	9.7	↗
15:	10.5	↘
16:	10.6x	→
17:	10.4	↑
18:	10.6x	↙
19:	10.3	↗
20:	9.4	↗
<b>Serie</b>		<b>98.0</b>
<b>Total</b>		<b>196.0</b>

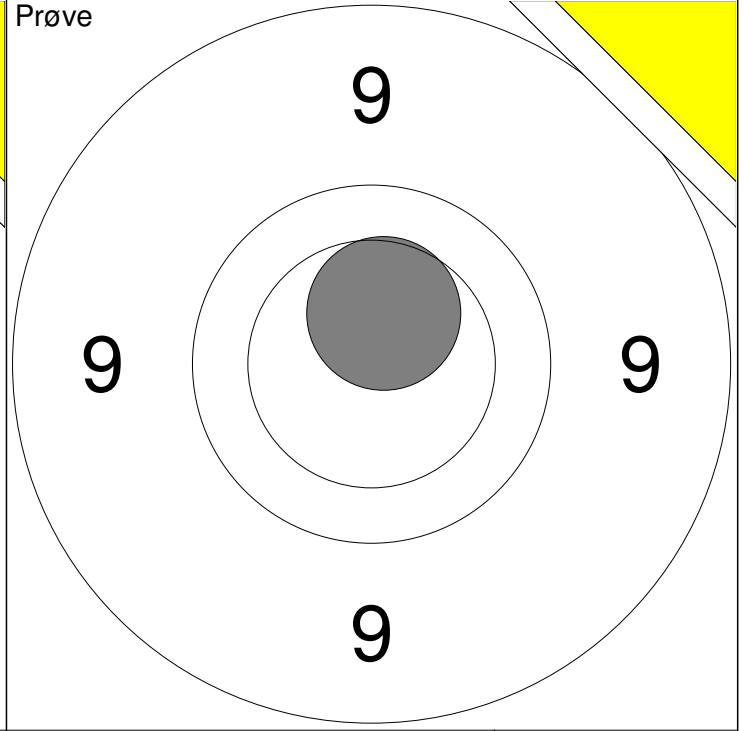
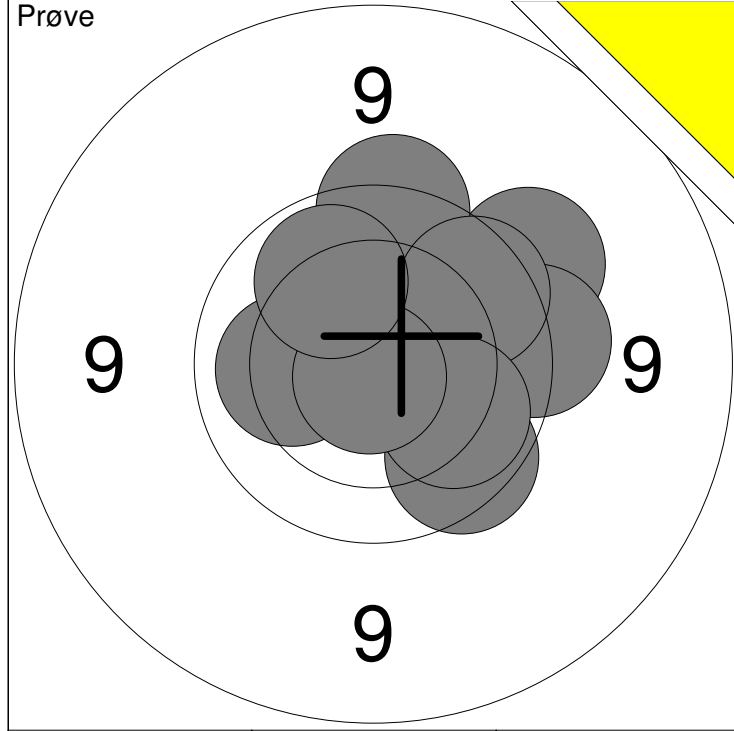

1: 9.5 ↗	6: 9.8 ↗	Serie	95
2: 10.4 ↑	7: 9.8 ↘		
3: 10.2 ←	8: 10.0 ↘	Total	0
4: 9.7 ↑	9: 10.8x ↓		
5: 9.6 →	10: 10.0 ↗		

11: 10.4 ↑	Serie	10
	Total	0

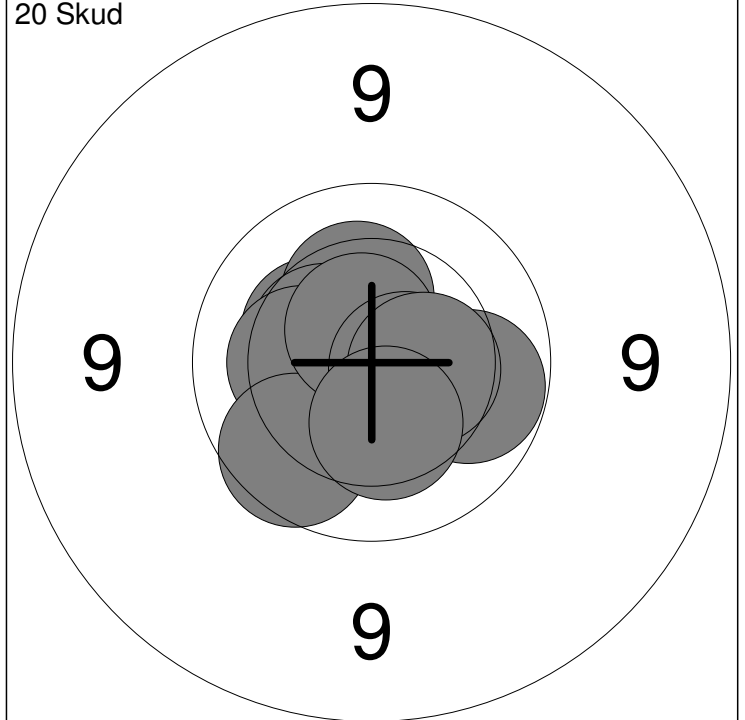
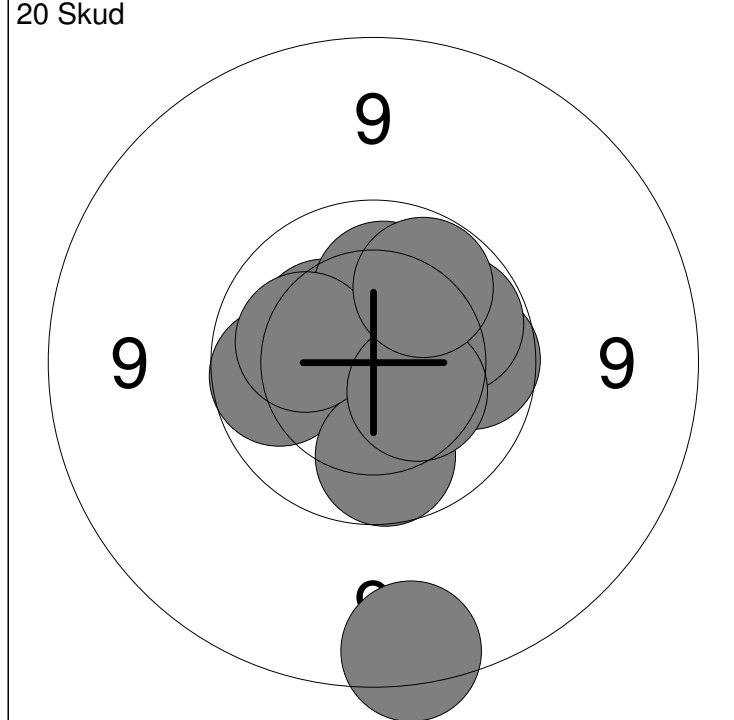

1: 10.3 ↖	6: 9.9 ↓	Serie	95
2: 8.8 ↓	7: 10.0 ↗		
3: 10.2 ↑	8: 10.2 ←	Total	95
4: 9.9 ←	9: 10.4 ↘		
5: 9.9 →	10: 10.0 ↗		

11: 10.4 ↖	16: 10.6x ↑	Serie	99
12: 10.3 ↑	17: 10.0 →		
13: 10.4 ↖	18: 10.6x →	Total	194
14: 10.3 ←	19: 10.4 →		
15: 9.9 ↙	20: 10.3 ↓		

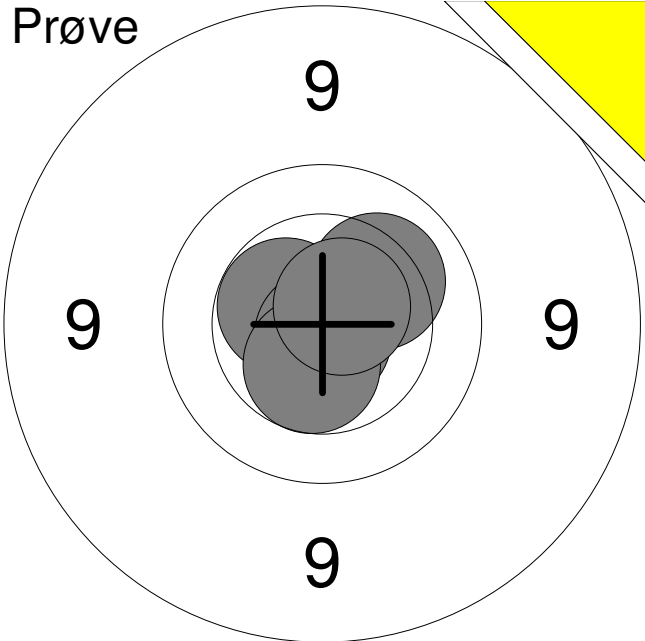
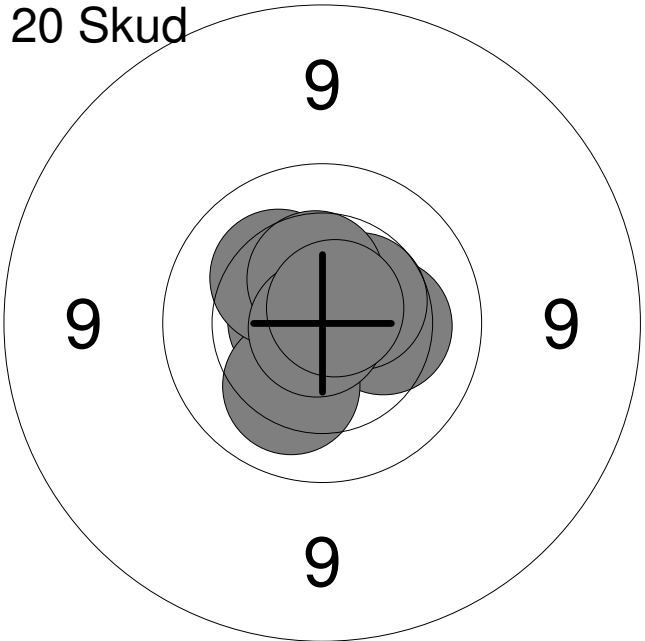
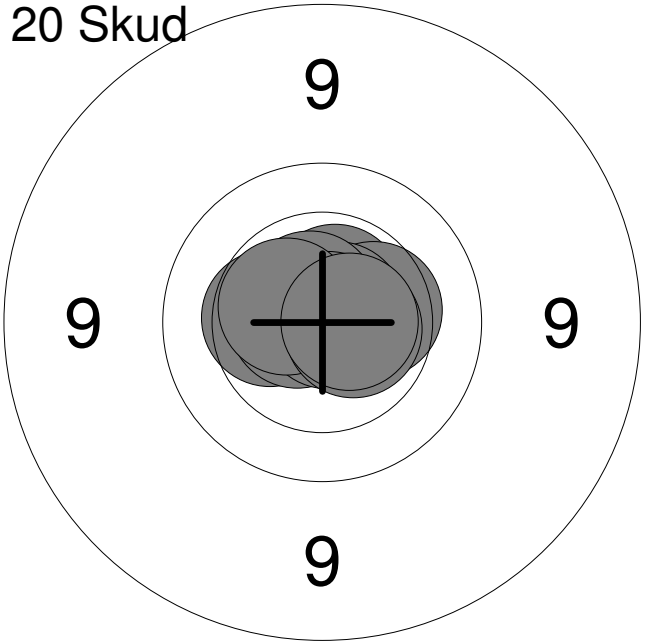
Hold <b>83</b>	Skive <b>11</b>	<b>Sune Grøn Bendixen</b>																																
AAS		Hjørring Skytteforening		MB1																														
02.02.2017		NM 2017 ungdom riffel		Aalborg Skyttekreds																														
<b>Prøve</b>		<table border="0"> <tr><td>1:</td><td>10.2</td><td>↗</td></tr> <tr><td>2:</td><td>10.5x</td><td>↖</td></tr> <tr><td>3:</td><td>10.8x</td><td>↓</td></tr> <tr><td>4:</td><td>10.5</td><td>↓</td></tr> <tr><td>5:</td><td>10.7x</td><td>↗</td></tr> </table>			1:	10.2	↗	2:	10.5x	↖	3:	10.8x	↓	4:	10.5	↓	5:	10.7x	↗															
1:	10.2	↗																																
2:	10.5x	↖																																
3:	10.8x	↓																																
4:	10.5	↓																																
5:	10.7x	↗																																
		Serie		50.0																														
		Total		0.0																														
<b>20 Skud</b>		<table border="0"> <tr><td>1:</td><td>10.8x</td><td>←</td></tr> <tr><td>2:</td><td>10.6x</td><td>↗</td></tr> <tr><td>3:</td><td>10.7x</td><td>←</td></tr> <tr><td>4:</td><td>10.3</td><td>→</td></tr> <tr><td>5:</td><td>10.2</td><td>↓</td></tr> <tr><td>6:</td><td>10.3</td><td>↗</td></tr> <tr><td>7:</td><td>10.5</td><td>↗</td></tr> <tr><td>8:</td><td>10.5</td><td>↑</td></tr> <tr><td>9:</td><td>10.9x</td><td>↙</td></tr> <tr><td>10:</td><td>10.7x</td><td>↗</td></tr> </table>			1:	10.8x	←	2:	10.6x	↗	3:	10.7x	←	4:	10.3	→	5:	10.2	↓	6:	10.3	↗	7:	10.5	↗	8:	10.5	↑	9:	10.9x	↙	10:	10.7x	↗
1:	10.8x	←																																
2:	10.6x	↗																																
3:	10.7x	←																																
4:	10.3	→																																
5:	10.2	↓																																
6:	10.3	↗																																
7:	10.5	↗																																
8:	10.5	↑																																
9:	10.9x	↙																																
10:	10.7x	↗																																
		Serie		100.0																														
		Total		100.0																														
<b>20 Skud</b>		<table border="0"> <tr><td>11:</td><td>10.6x</td><td>↗</td></tr> <tr><td>12:</td><td>10.4</td><td>→</td></tr> <tr><td>13:</td><td>10.7x</td><td>↗</td></tr> <tr><td>14:</td><td>10.7x</td><td>↗</td></tr> <tr><td>15:</td><td>10.4</td><td>←</td></tr> <tr><td>16:</td><td>10.7x</td><td>←</td></tr> <tr><td>17:</td><td>10.9x</td><td>→</td></tr> <tr><td>18:</td><td>10.5x</td><td>↖</td></tr> <tr><td>19:</td><td>10.6x</td><td>→</td></tr> <tr><td>20:</td><td>10.6x</td><td>→</td></tr> </table>			11:	10.6x	↗	12:	10.4	→	13:	10.7x	↗	14:	10.7x	↗	15:	10.4	←	16:	10.7x	←	17:	10.9x	→	18:	10.5x	↖	19:	10.6x	→	20:	10.6x	→
11:	10.6x	↗																																
12:	10.4	→																																
13:	10.7x	↗																																
14:	10.7x	↗																																
15:	10.4	←																																
16:	10.7x	←																																
17:	10.9x	→																																
18:	10.5x	↖																																
19:	10.6x	→																																
20:	10.6x	→																																
		Serie		100.0																														
		Total		200.0																														

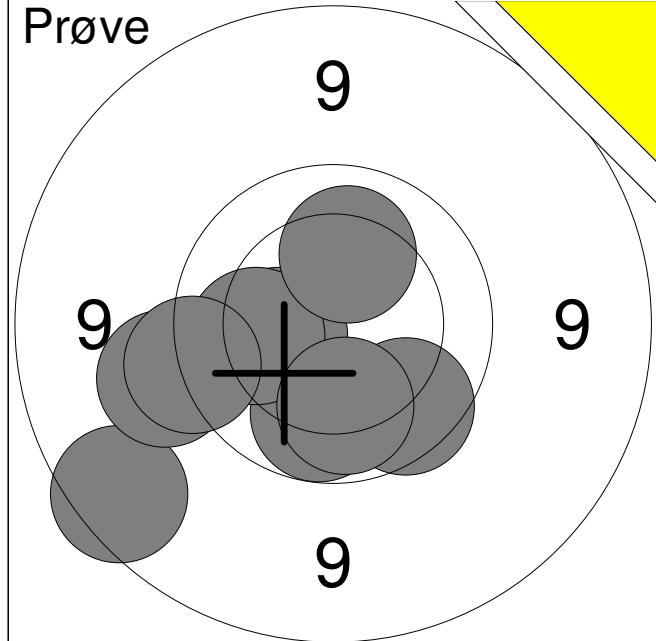

1:	8.9	↙
2:	9.4	←
3:	10.3	←
4:	10.0	↓
5:	10.1	←
6:	9.8	↘
7:	10.0	↓
8:	9.6	←
9:	10.2	↑
<b>Serie</b>		<b>85.0</b>
<b>Total</b>		<b>0.0</b>

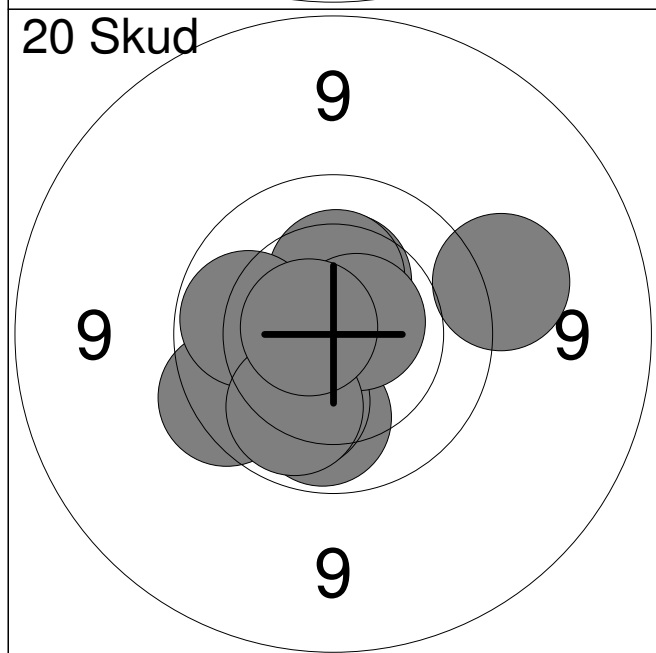

1:	9.4	→
2:	10.4	↑
3:	9.7	←
4:	10.3	↑
5:	10.0	↓
6:	10.1	↓
7:	10.0	←
8:	10.7x	→
9:	10.0	↓
10:	10.7x	←
<b>Serie</b>		<b>98.0</b>
<b>Total</b>		<b>98.0</b>

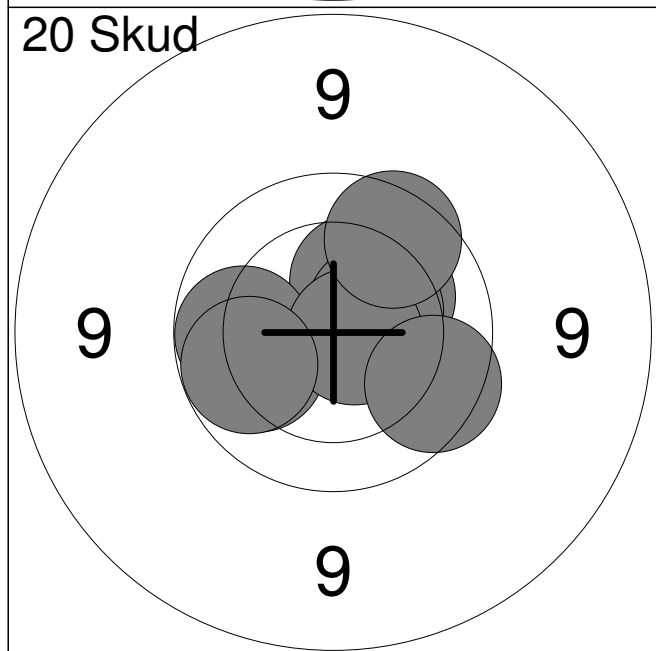

11:	10.4	↗
12:	10.0	←
13:	10.3	↗
14:	10.0	←
15:	10.2	↗
16:	10.4	↗
17:	10.7x	→
18:	10.0	←
19:	9.8	↘
20:	9.8	↗
<b>Serie</b>		<b>98.0</b>
<b>Total</b>		<b>196.0</b>

Hold	Skive	Alexander Larsen		
84	1	Skf. Kimbrerne		MB2
02.02.2017	NM 2017 ungdom riffel		Aalborg Skyttekreds	
Prøve		1:	9.7	↗
		2:	10.6x	↑
		3:	10.0	→
		4:	10.2	↘
		5:	10.8x	↘
		Serie	49.0	
		Total	0.0	
20 Skud		1:	10.5x	←
		2:	10.5x	→
		3:	10.6x	←
		4:	10.5x	↗
		5:	9.8	↘
		6:	10.1	↗
		7:	10.5x	↗
		8:	10.4	↘
		9:	10.0	↗
		10:	10.2	←
		Serie	99.0	
		Total	99.0	
20 Skud		11:	10.6x	→
		12:	10.4	←
		13:	10.0	↗
		14:	10.6x	↗
		15:	10.0	←
		16:	10.5	↘
		17:	10.4	↗
		18:	10.2	↗
		19:	10.6x	→
		20:	10.5x	↑
		Serie	100.0	
		Total	199.0	

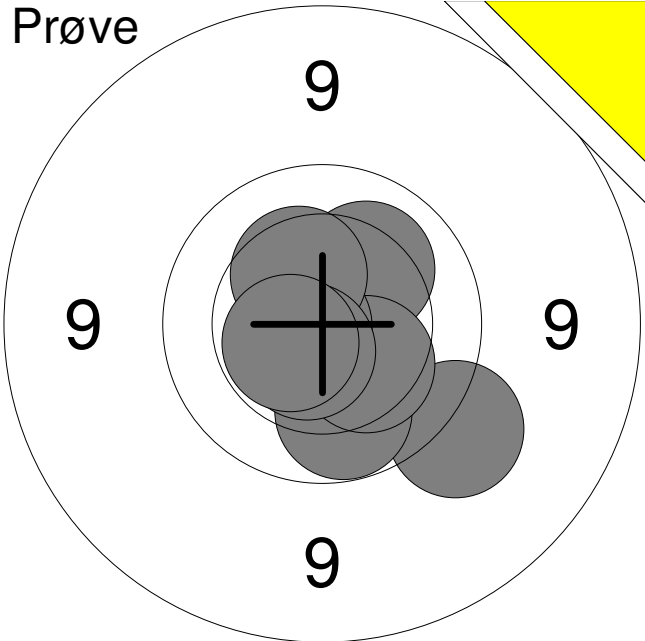
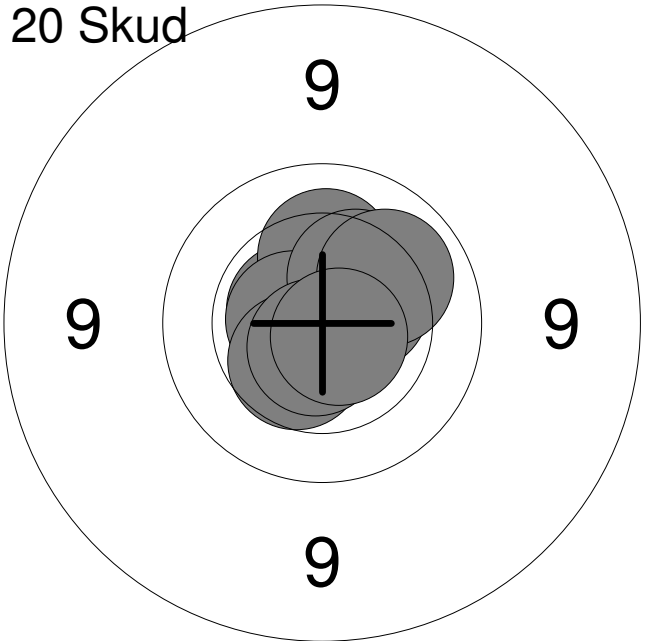
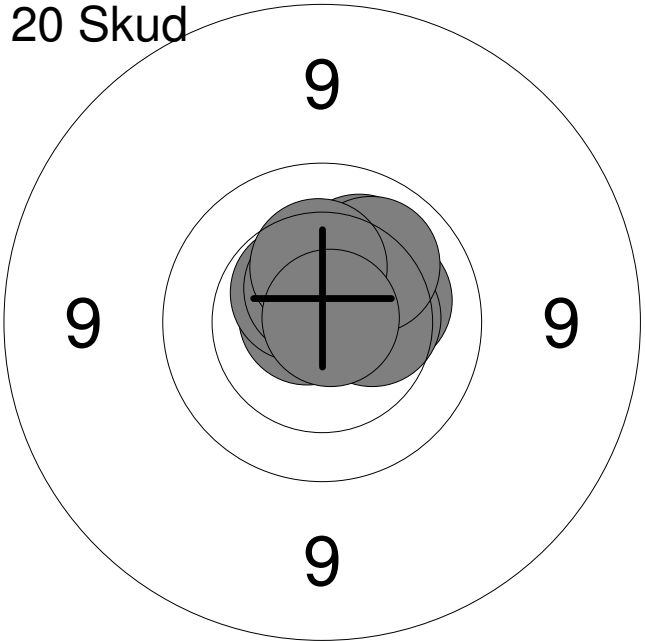

Hold	Skive	Esajas Hvorvarp	
84	2	Vilsted Skf.	BK1
02.02.2017	NM 2017 ungdom riffel	Aalborg Skyttekreds	
<b>Prøve</b> 	1:	9.5	↘
	2:	10.0	↓
	3:	10.8x	↘
	4:	10.2	↗
	5:	10.3	↘
	6:	10.7x	←
	7:	10.4	↗
	8:	10.6x	↘
	9:	10.5x	↙
	Serie		89.0
Total		0.0	
<b>20 Skud</b> 	1:	10.6x	↙
	2:	10.5x	↑
	3:	10.2	↑
	4:	10.6x	←
	5:	10.4	↘
	6:	10.5	↗
	7:	10.3	↗
	8:	10.1	↗
	9:	10.7x	↓
	10:	10.7x	↘
Serie		100.0	
Total		100.0	
<b>20 Skud</b> 	11:	10.8x	↙
	12:	10.2	↗
	13:	10.5x	↗
	14:	10.6x	↑
	15:	10.2	↗
	16:	10.2	↗
	17:	10.4	→
	18:	10.1	↗
	19:	10.3	↑
	20:	10.8x	↗
Serie		100.0	
Total		200.0	

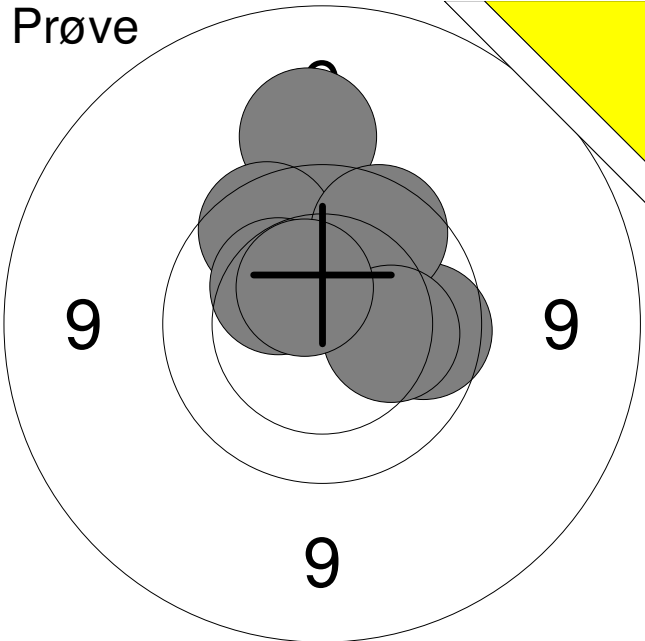
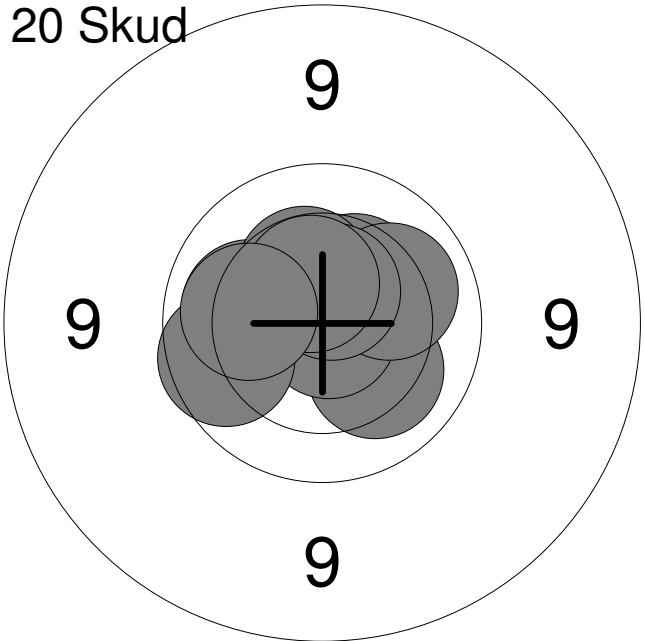
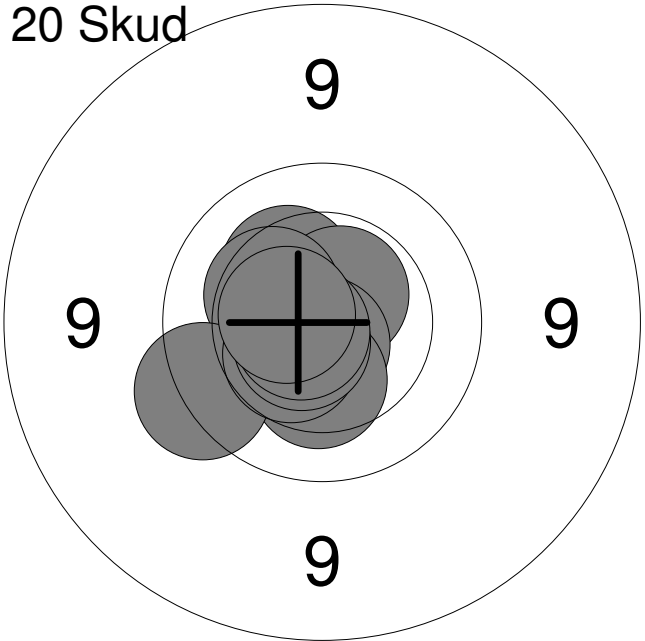
Hold	Skive	William Larsen		
84	3	Skf. Kimbrerne		MB3
02.02.2017	NM 2017 ungdom riffel		Aalborg Skyttekreds	
Prøve		1:	9.3	↑
		2:	9.8	↗
		3:	9.9	→
		4:	10.3	↗
		5:	9.8	↗
		6:	10.2	→
		7:	10.5x	↗
		Serie		66.0
		Total		0.0
20 Skud		1:	10.1	←
		2:	10.2	↘
		3:	10.8x	↘
		4:	10.4	↗
		5:	10.1	↗
		6:	10.4	↑
		7:	10.6x	↑
		8:	9.9	←
		9:	10.5x	↑
		10:	10.1	←
		Serie		99.0
		Total		99.0
20 Skud		11:	10.3	↗
		12:	10.6x	↗
		13:	10.7x	↓
		14:	10.3	↖
		15:	10.3	↓
		16:	9.7	←
		17:	10.5	↘
		18:	10.6x	↘
		19:	10.7x	←
		20:	10.6x	←
		Serie		99.0
		Total		198.0

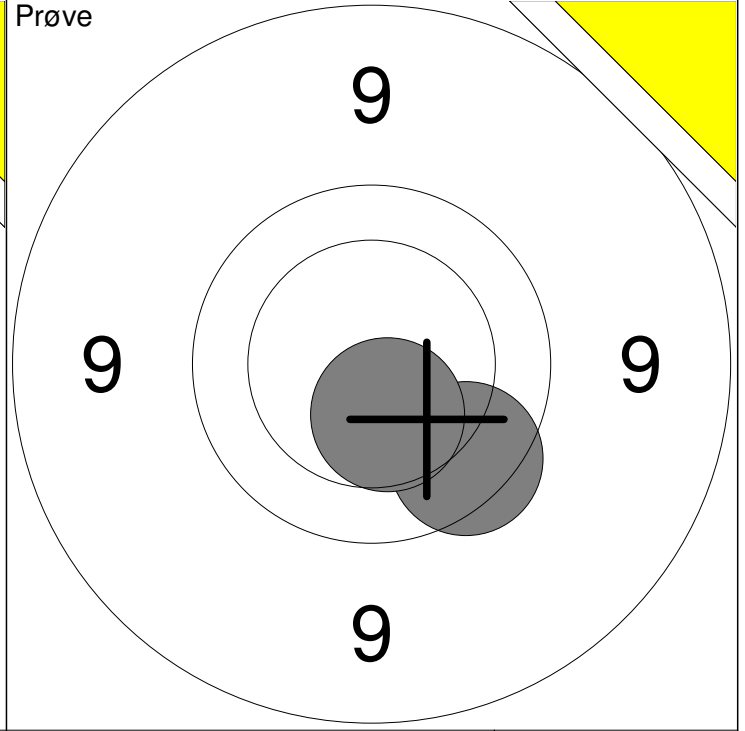
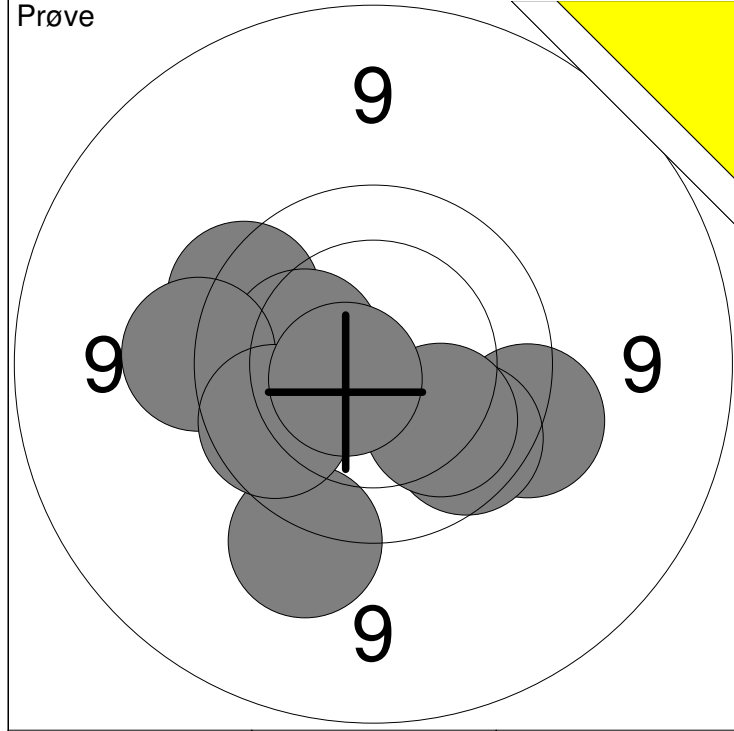

1: 9.5 ↘	6: 9.9 ↘	Serie	94
2: 9.6 ↗	7: 9.5 ←		
3: 9.7 ↗	8: 10.1 ↘	Total	0
4: 10.2 ←	9: 9.9 ↘		
5: 10.3 ←	10: 10.6x ←		

11: 9.8 ↘	Serie	19
12: 10.4 ↘		
	Total	0

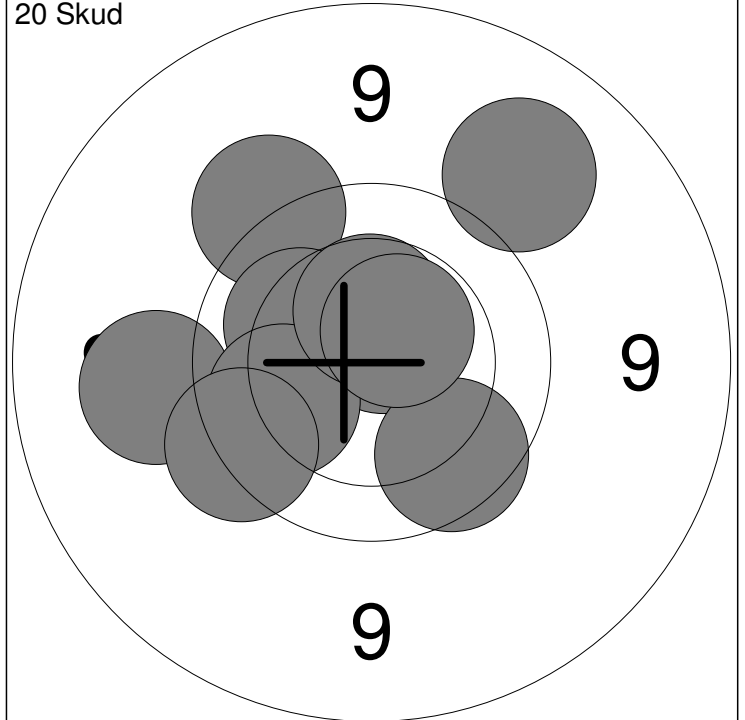
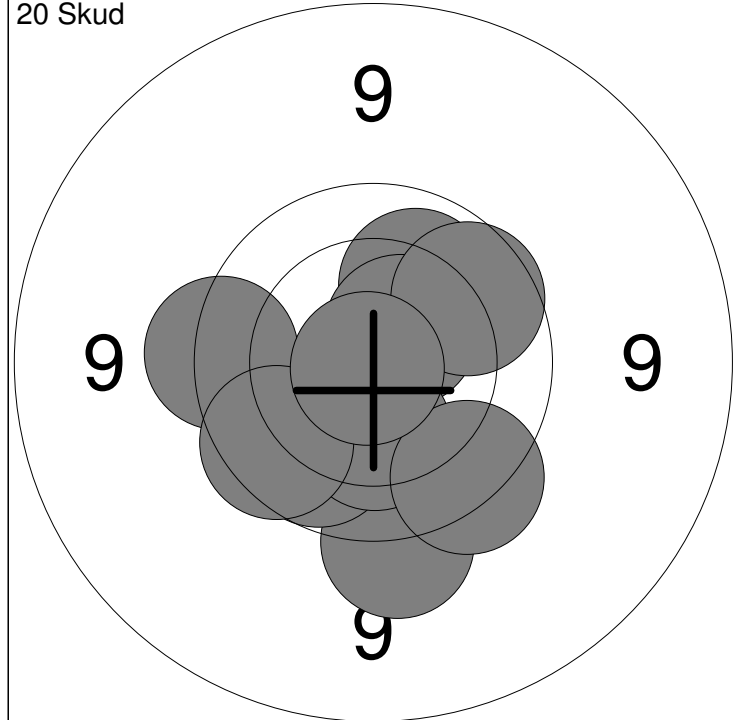

1: 9.7 ←	6: 9.9 ↘	Serie	94
2: 9.5 ↘	7: 10.2 ↘		
3: 10.1 ↗	8: 9.7 ↘	Total	94
4: 10.5x ↗	9: 9.8 ↘		
5: 9.9 ↗	10: 10.9x ↘		

11: 9.5 ↗	16: 10.0 ←	Serie	95
12: 9.3 ←	17: 9.7 ↘		
13: 10.7x ↗	18: 9.8 ↘	Total	189
14: 9.2 ↗	19: 10.4 ↑		
15: 10.2 ←	20: 10.6x ↗		

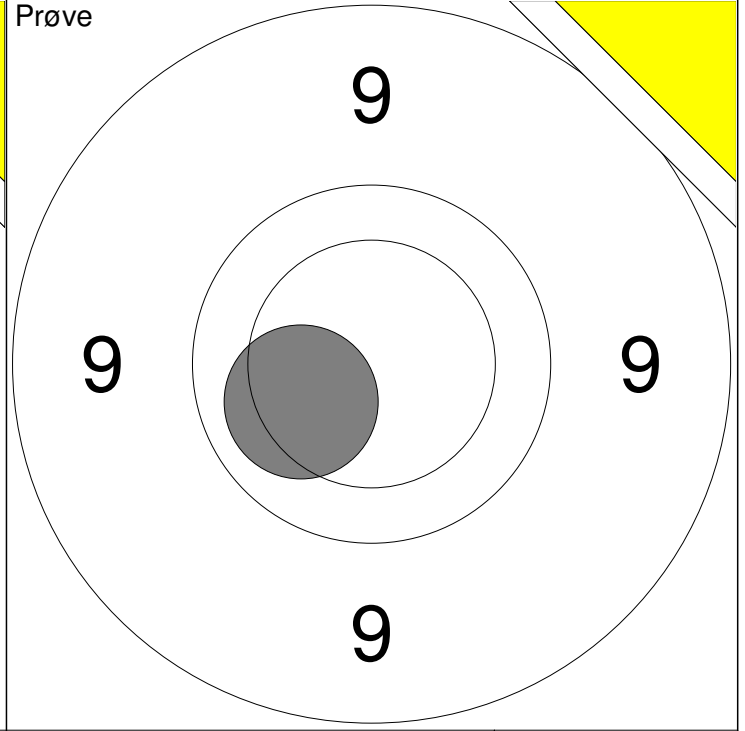
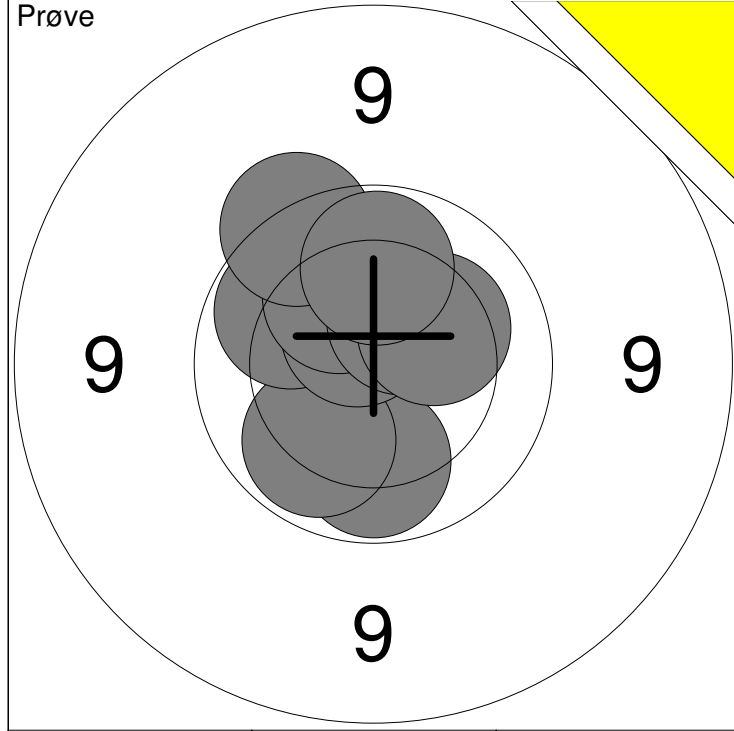

1: 10.0 ↓	6: 10.2 ↗	Serie	99
2: 10.0 ↘	7: 10.4 ↗		
3: 10.0 ↗	8: 10.3 ↗	Total	0
4: 10.0 ↗	9: 9.7 ↗		
5: 10.6x ↗	10: 10.0 ↑		

11: 10.2 ↙	Serie	10
	Total	0

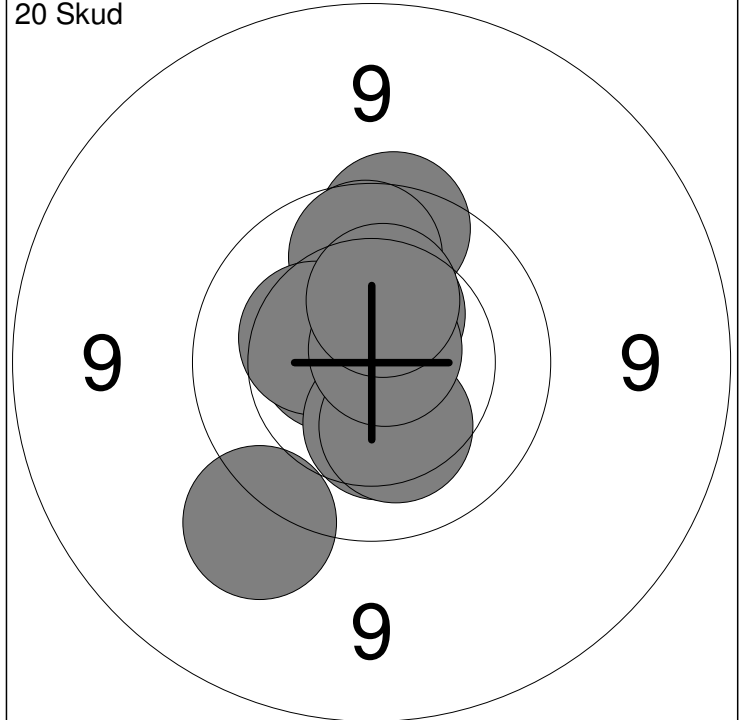
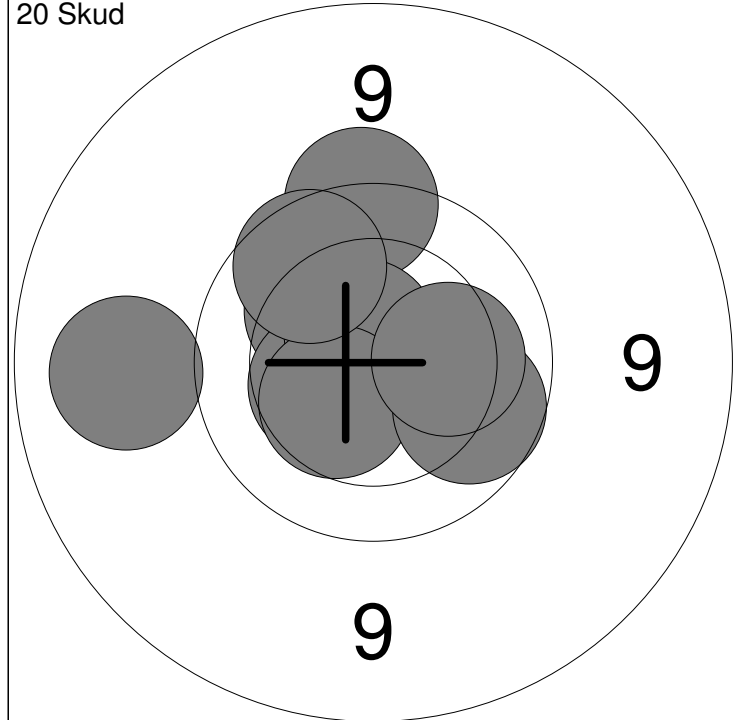

1: 10.8x ←	6: 10.4 ↘	Serie	96
2: 10.2 ↗	7: 9.1 ←		
3: 9.6 ↑	8: 9.9 ↗	Total	96
4: 10.4 ←	9: 9.9 →		
5: 10.7x ↗	10: 10.2 →		

11: 10.6x ←	16: 10.5 ↗	Serie	97
12: 9.8 ↑	17: 10.4 ↓		
13: 9.9 ↑	18: 10.3 ↓	Total	193
14: 9.4 ↘	19: 10.8x ↗		
15: 10.4 ←	20: 10.3 ↑		

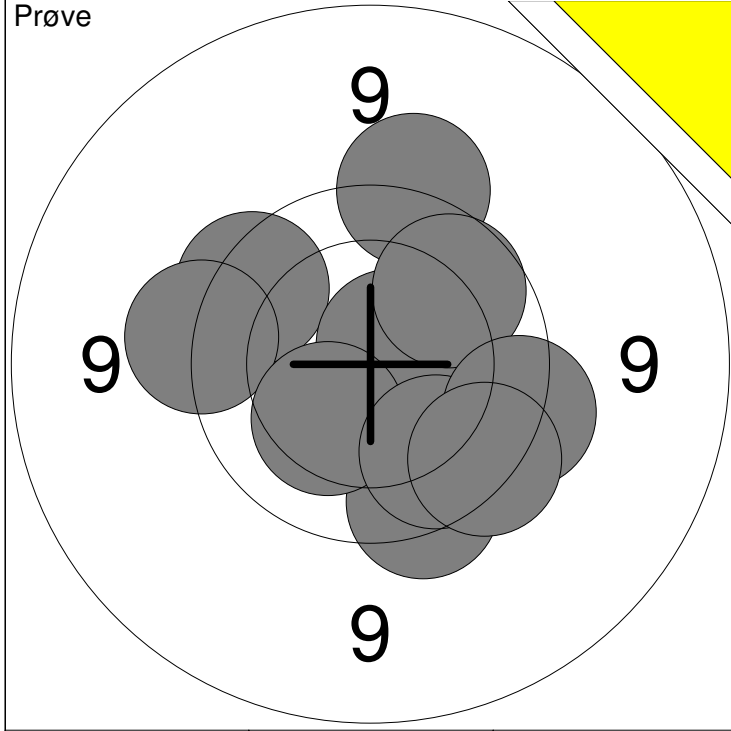

1: 9.7 ↖	6: 9.9 ↗	<b>Serie</b>	92
2: 9.6 ←	7: 10.3 ↘		
3: 9.7 ↓	8: 9.9 ↓	<b>Total</b>	0
4: 10.7x ↗	9: 9.6 →		
5: 9.5 ↑	10: 9.7 ↘		

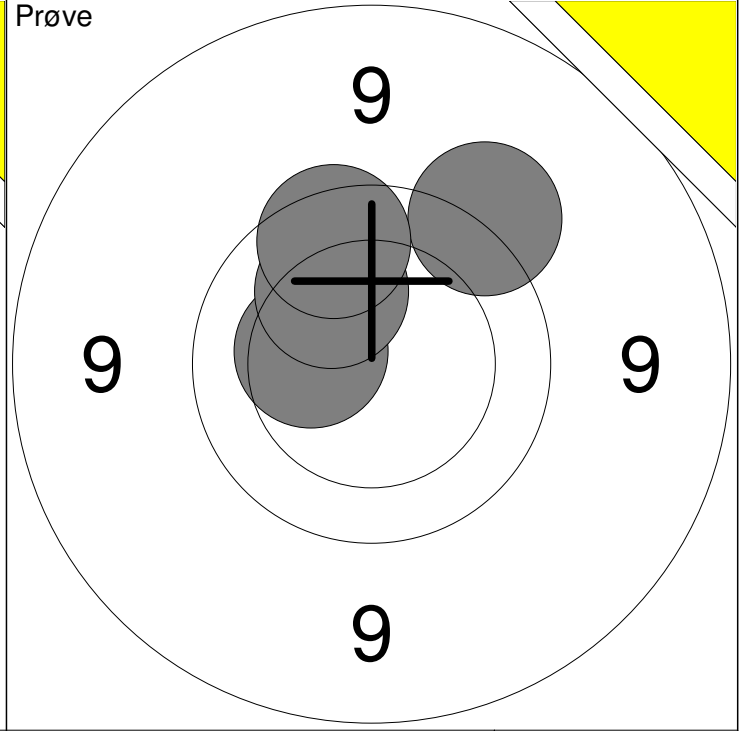

11: 9.5 ↗	<b>Serie</b>	38
12: 10.3 ←		
13: 10.1 ↗	<b>Total</b>	0
14: 9.8 ↗		

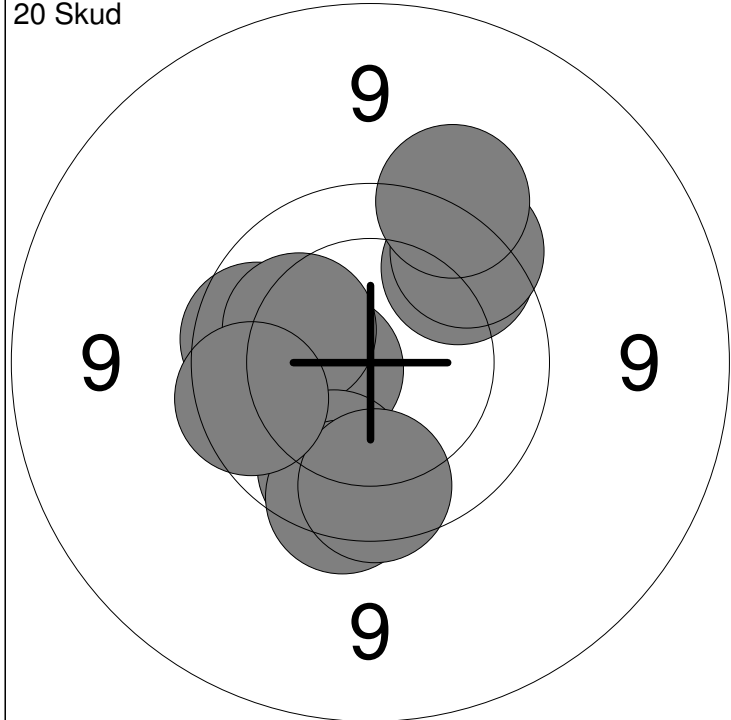

1: 9.9 ←	6: 9.9 ↓	<b>Serie</b>	92
2: 9.8 ↗	7: 9.5 ↗		
3: 9.7 ↗	8: 9.8 ↓	<b>Total</b>	92
4: 10.5x ←	9: 9.8 ↓		
5: 10.2 ←	10: 9.8 ←		

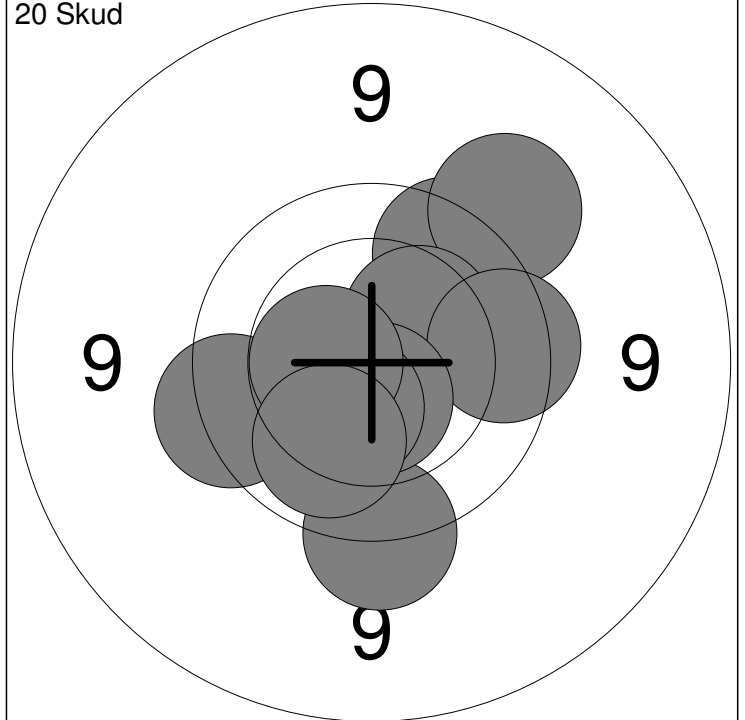

11: 9.7 ←	16: 9.8 →	<b>Serie</b>	95
12: 9.8 ↗	17: 10.6x ↓		
13: 9.4 ↗	18: 10.4 ↓	<b>Total</b>	187
14: 9.6 ↓	19: 10.5x ←		
15: 10.3 ↗	20: 10.1 ↓		

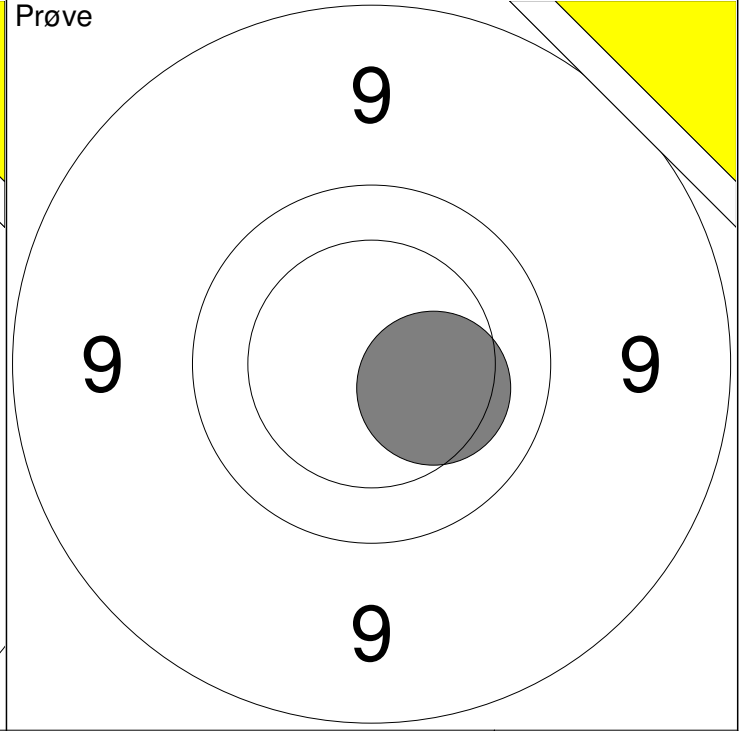
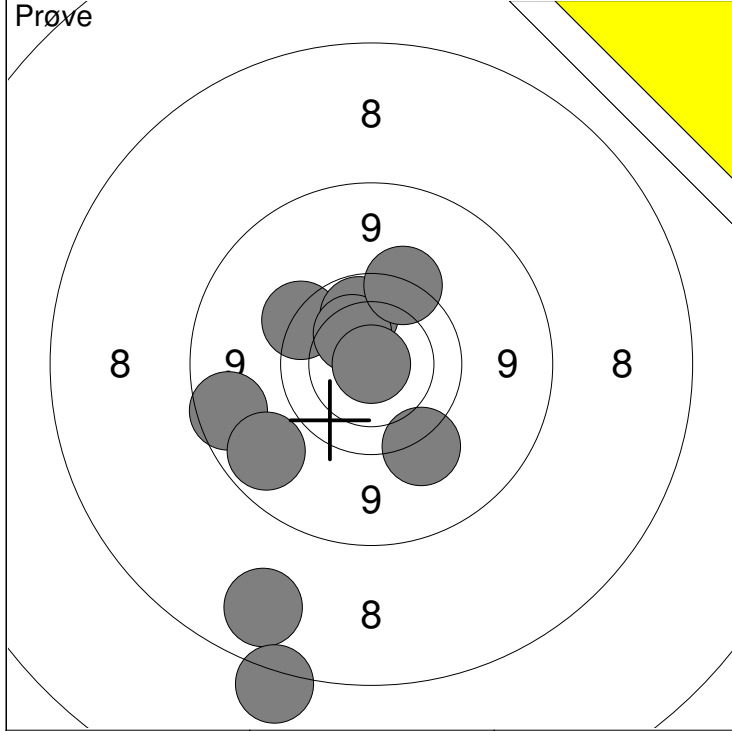

1: 8.1 ↘	6: 10.0 ↗	Serie	89
2: 7.6 ↘	7: 10.3 ↗		
3: 8.9 ↙	8: 9.6 ↗	Total	0
4: 9.0 ↙	9: 10.9x ↘		
5: 9.6 ↗	10: 9.5 ↘		

11: 10.3 →	Serie	10
	Total	0

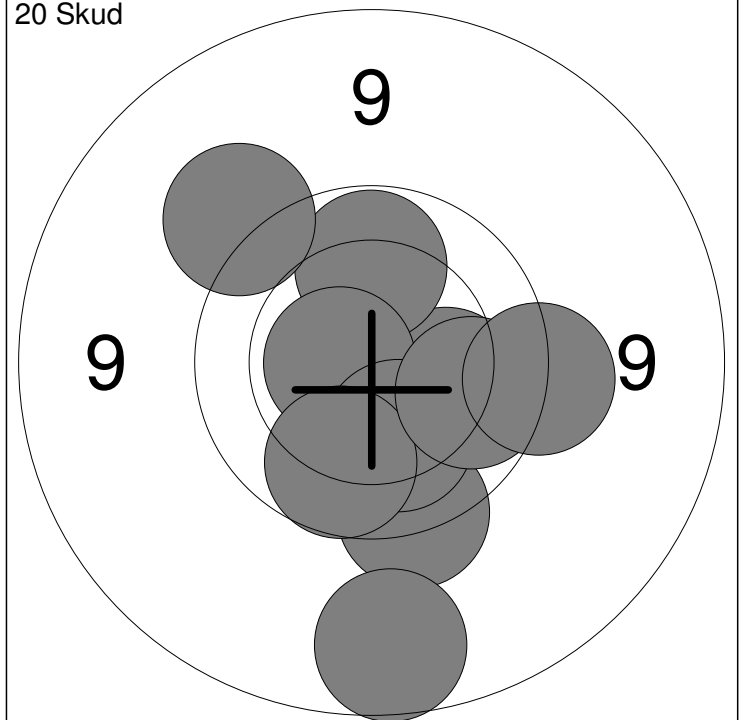
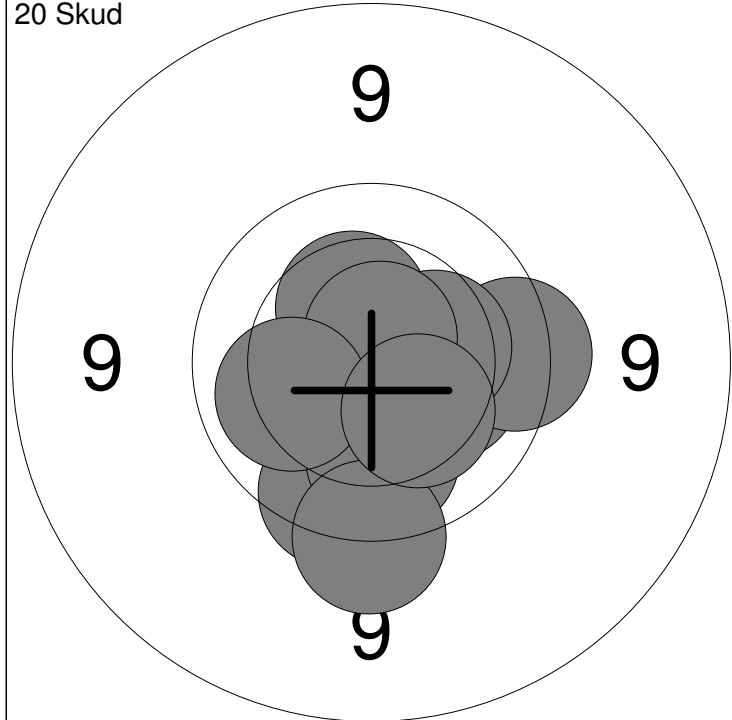

1: 10.2 →	6: 10.7x ↗	Serie	97
2: 9.7 →	7: 10.0 ↘		
3: 10.4 ↗	8: 9.5 ↘	Total	97
4: 10.3 →	9: 10.1 ↙		
5: 9.8 ↘	10: 10.3 ↘		

11: 10.2 →	16: 9.9 ↘	Serie	93
12: 9.6 ↘	17: 9.9 →		
13: 10.0 ↗	18: 9.4 ↗	Total	190
14: 10.6x ↙	19: 8.9 ↘		
15: 10.2 ↘	20: 9.6 →		

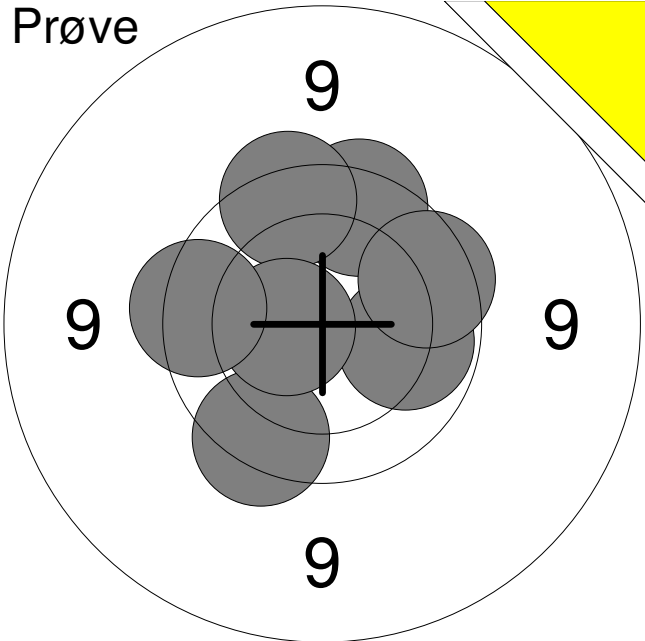
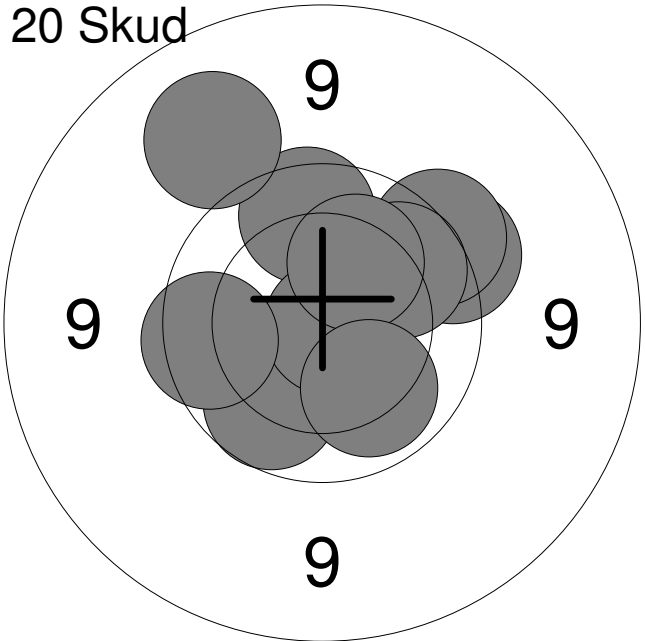
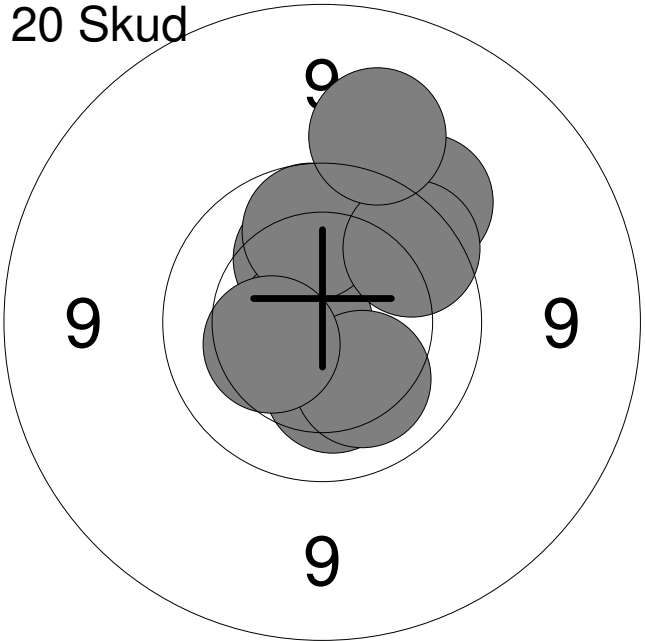
Hold	Skive		
84	8	Inegu Cortzen	
AAS		Vilsted Skf.	MB3
02.02.2017	NM 2017 ungdom riffel	Aalborg Skyttekreds	
Prøve		1: 10.0 →	
		2: 9.7 ↓	
		3: 9.8 ↑	
		4: 9.7 ↑	
		5: 9.8 →	
		6: 10.6x ←	
		7: 9.7 ←	
		Serie	65.0
		Total	0.0
20 Skud		1: 9.6 →	
		2: 9.9 ↓	
		3: 9.8 ↑	
		4: 10.8x →	
		5: 9.6 →	
		6: 9.8 ←	
		7: 9.9 →	
		8: 10.2 ↑	
		9: 10.1 ↓	
		10: 9.2 ↑	
		Serie	93.0
		Total	93.0
20 Skud		11: 9.5 ↗	
		12: 10.3 ↓	
		13: 9.9 ↑	
		14: 10.2 ↑	
		15: 10.7x ←	
		16: 10.2 ↓	
		17: 9.9 ↑	
		18: 9.8 →	
		19: 10.3 ←	
		20: 9.3 ↑	
		Serie	95.0
		Total	188.0

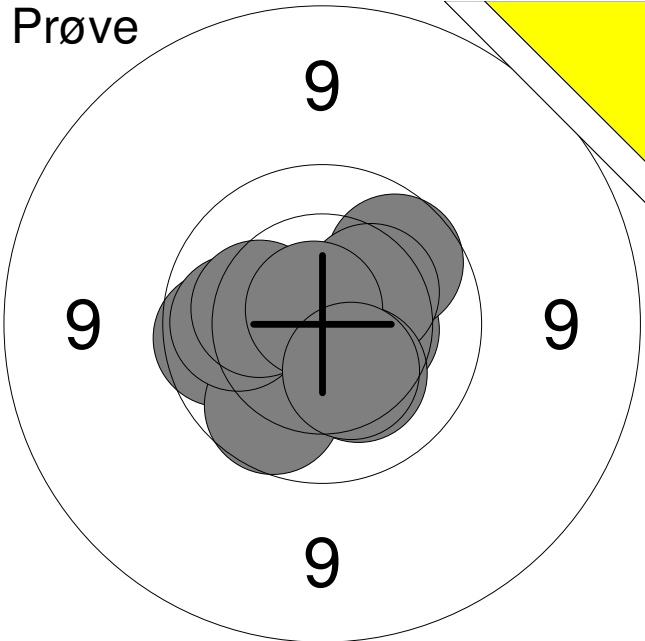
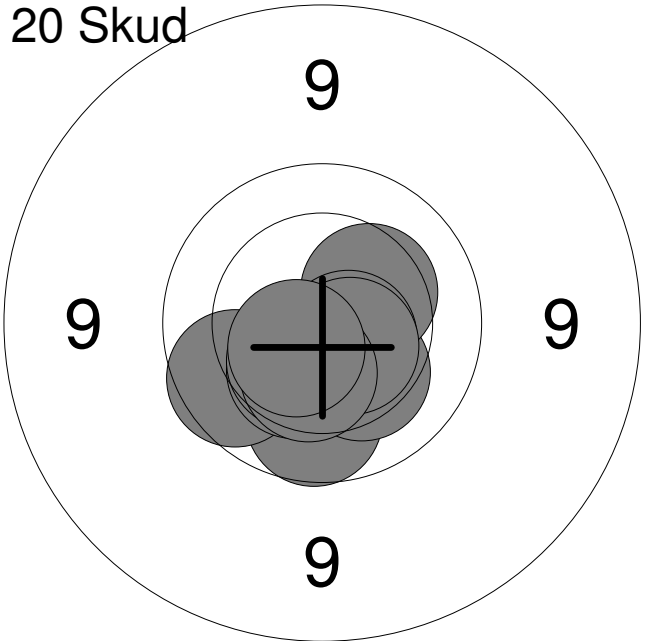
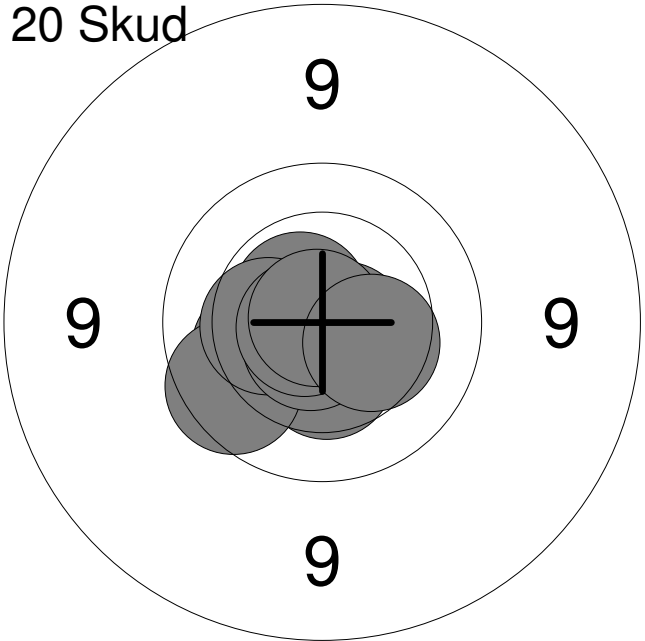
Hold	Skive		
84	9	David Rønn	
AAS		Aalborg Skyttekreds	MJ2
02.02.2017	NM 2017 ungdom riffel	Aalborg Skyttekreds	
Prøve		1: 10.4 →	
		2: 9.9 ↗	
		3: 9.9 ←	
		4: 10.3 ↗	
		5: 10.3 ↓	
		6: 9.9 ↓	
		7: 10.0 ←	
		8: 10.2 ←	
		9: 10.8x ↗	
		10: 10.3 ↓	
		Serie	97.0
		Total	0.0
20 Skud		1: 9.9 ↓	
		2: 10.3 ↓	
		3: 10.3 ↗	
		4: 10.6x ↘	
		5: 9.9 ←	
		6: 10.4 ↓	
		7: 10.4 ↓	
		8: 10.6x ↘	
		9: 10.4 ↓	
		10: 10.6x ↘	
		Serie	98.0
		Total	98.0
20 Skud		11: 10.7x →	
		12: 10.6x ↗	
		13: 10.4 ↓	
		14: 10.2 ←	
		15: 9.8 ←	
		16: 10.4 ←	
		17: 10.7x ↓	
		18: 10.7x ←	
		19: 10.9x ↗	
		20: 10.4 →	
		Serie	99.0
		Total	197.0

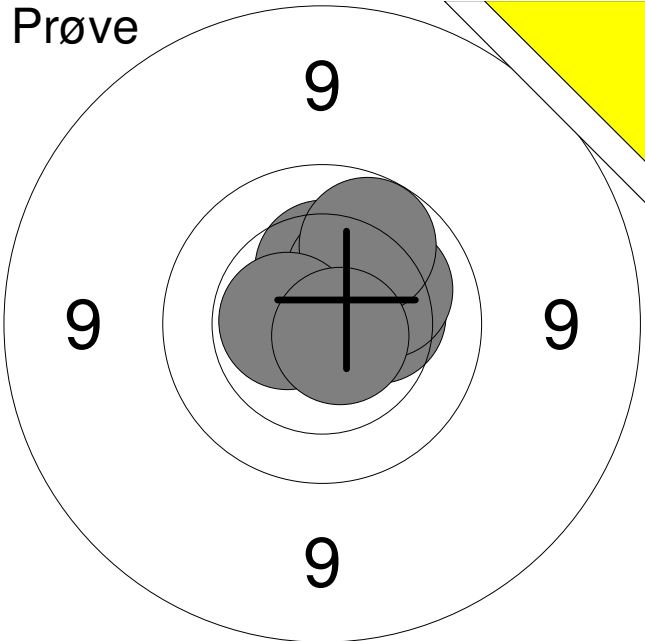
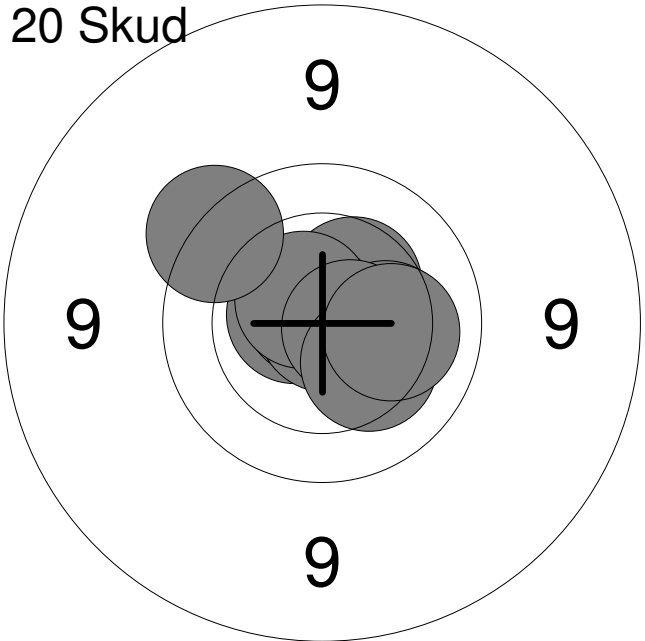
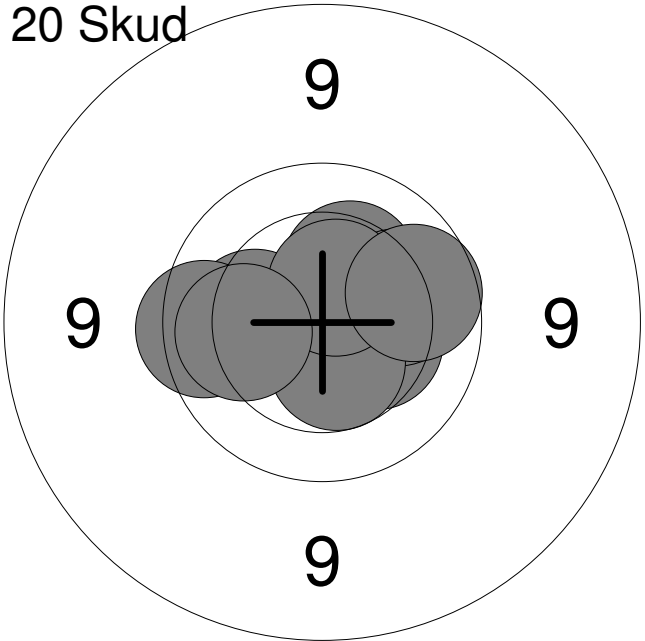

Hold	Skive	Nicklas Christensen		
84	10	Aalborg Skyttekreds	J1	
02.02.2017	NM 2017 ungdom riffel	Aalborg Skyttekreds		
Prøve		1: 10.3	→	
		2: 10.6x	↗	
		3: 10.3	↑	
		4: 10.3	↗	
		5: 10.2	↗	
		6: 10.0	↗	
		7: 10.6x	←	
		8: 10.7x	↘	
		<b>Serie</b>		<b>80.0</b>
		<b>Total</b>		<b>0.0</b>
20 Skud		1: 10.6x	←	
		2: 10.4	↗	
		3: 10.2	→	
		4: 10.8x	↗	
		5: 10.9x	→	
		6: 10.6x	↗	
		7: 9.6	↗	
		8: 10.6x	→	
		9: 10.3	↘	
		10: 10.2	→	
		<b>Serie</b>		<b>99.0</b>
		<b>Total</b>		<b>99.0</b>
20 Skud		11: 10.2	←	
		12: 10.3	→	
		13: 10.3	↗	
		14: 10.1	→	
		15: 10.9x	↗	
		16: 10.5	↘	
		17: 10.5x	↗	
		18: 9.8	←	
		19: 10.1	←	
		20: 9.9	→	
		<b>Serie</b>		<b>98.0</b>
		<b>Total</b>		<b>197.0</b>

Hold	Skive		
84	12	Niklas Pedersen	
AAS		Aalborg Skyttekreds	J2
02.02.2017	NM 2017 ungdom riffel	Aalborg Skyttekreds	
Prøve		1:	10.8x ↗
		2:	10.2 ↗
		3:	10.3 ↖
		4:	10.0 ↘
		5:	10.6x ↘
		6:	9.9 ↘
		7:	10.2 →
		Serie	69.0
		Total	0.0
20 Skud		1:	10.7x ↗
		2:	10.1 ↗
		3:	10.2 ↗
		4:	9.6 ↘
		5:	9.9 ↘
		6:	10.5 ↑
		7:	10.7x →
		8:	10.1 ↗
		9:	10.5x ←
		10:	10.4 ↑
		Serie	98.0
		Total	98.0
20 Skud		11:	9.8 ↗
		12:	10.7x ↘
		13:	10.8x →
		14:	9.9 ↗
		15:	10.6x ↖
		16:	10.7x ←
		17:	10.2 ↘
		18:	10.9x ↘
		19:	10.7x ↑
		20:	10.6x ←
		Serie	98.0
		Total	196.0

Hold	Skive	Rasmus Mikkelsen	
85	1	Vilsted Skf.	BK2
02.02.2017	NM 2017 ungdom riffel	Aalborg Skyttekreds	
Prøve		Prøve	
	1: 7.7 ↗ 2: 8.0 ↗ 3: 8.5 ↗ 4: 10.4 ↖ 5: 9.6 ↗ 6: 8.7 ↗ 7: 9.1 ↗ 8: 9.5 ↗ 9: 9.0 ↘ 10: 9.1 ↗ Serie 86.0 Total 0.0		11: 9.4 ↗ 12: 9.5 ↗ 13: 9.2 → 14: 9.9 ↑ 15: 10.2 → 16: 10.2 ↗ 17: 10.1 → 18: 10.6 ↖ 19: 9.9 ↗ 20: 9.8 ↘ Serie 94.0 Total 0.0
Prøve		20 Skud	
	21: 9.9 → 22: 10.4 ↑ 23: 10.7x↗ Serie 29.0 Total 0.0		1: 10.8x↖ 2: 10.2 ↓ 3: 10.4 ↓ 4: 9.6 ↗ 5: 10.1 ↗ 6: 10.9x↗ 7: 9.3 ↖ 8: 10.5 ↗ 9: 10.1 ↘ 10: 9.9 ↗ Serie 97.0 Total 97.0
20 Skud			
	11: 10.7x↖ 12: 9.9 ↗ 13: 10.0 ↑ 14: 9.6 ↗ 15: 10.6x↖ 16: 10.5 ↓ 17: 10.0 ↖ 18: 10.1 ↓ 19: 9.5 ↓ 20: 9.5 ↗ Serie 96.0 Total 193.0		

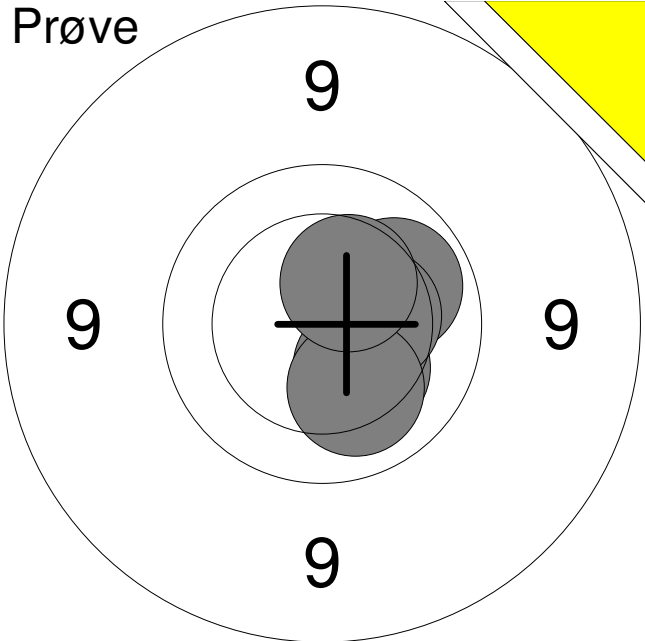
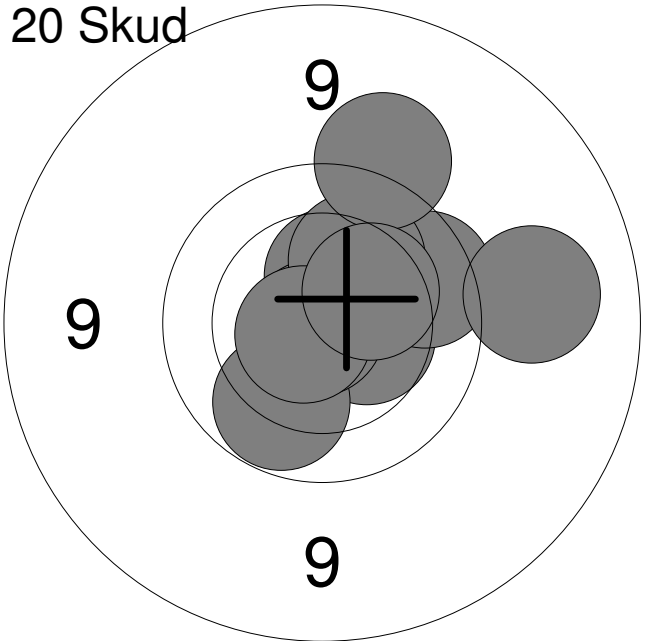
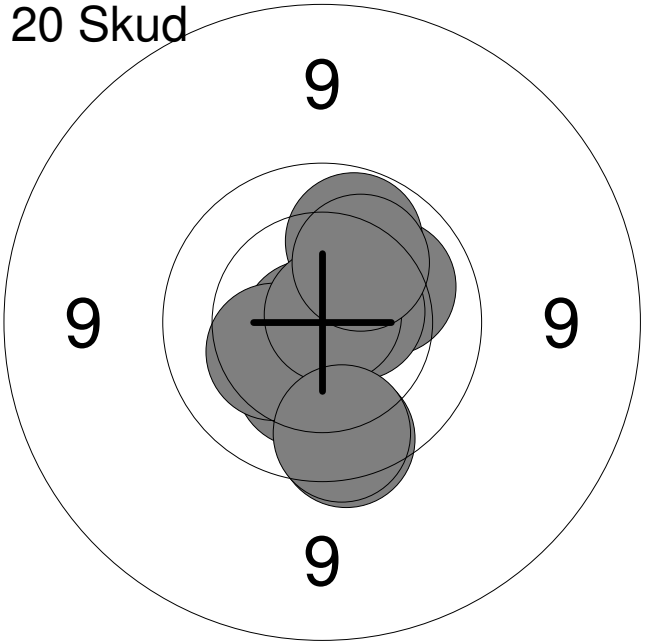
Hold	Skive	Frederik H. Andersen	
85	2	AAS	Skf. Kimbrerne MJ2
02.02.2017	NM 2017 ungdom riffel	Aalborg Skyttekreds	
Prøve		1: 10.1	↗
		2: 10.3	↘
		3: 10.4	→
		4: 10.2	↘
		5: 10.4	↗
	Serie	50.0	
	Total	0.0	
20 Skud		1: 10.4	→
		2: 9.8	→
		3: 9.2	→
		4: 10.0	↘
		5: 10.4	↑
		6: 10.9x	↙
		7: 10.2	↗
		8: 9.4	↑
		9: 10.7x	↙
		10: 10.3	↗
	Serie	97.0	
	Total	97.0	
20 Skud		11: 10.1	↗
		12: 10.0	↑
		13: 10.8x	↙
		14: 9.8	↘
		15: 10.3	↘
		16: 10.3	↙
		17: 10.6x	→
		18: 10.8x	↗
		19: 10.2	↗
		20: 9.8	↘
	Serie	98.0	
	Total	195.0	

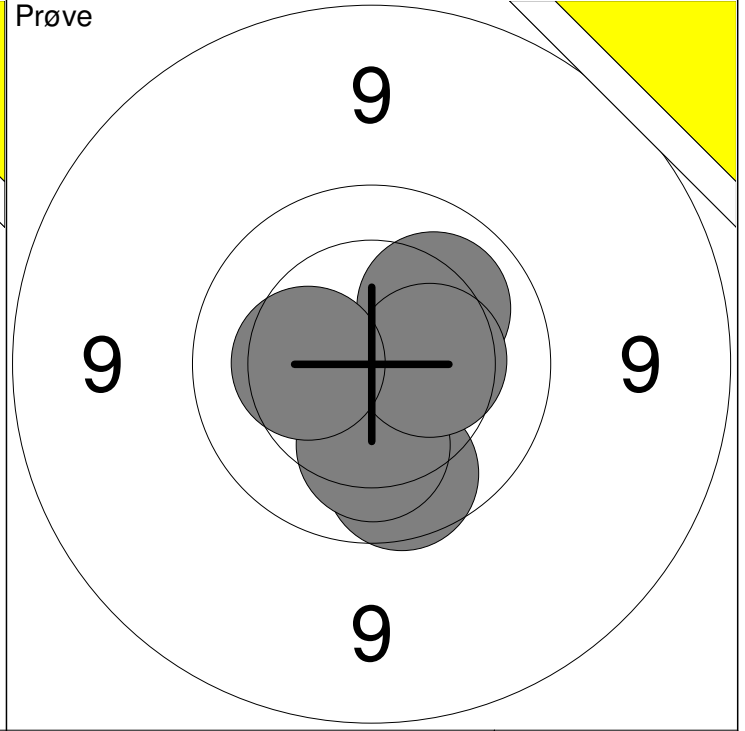
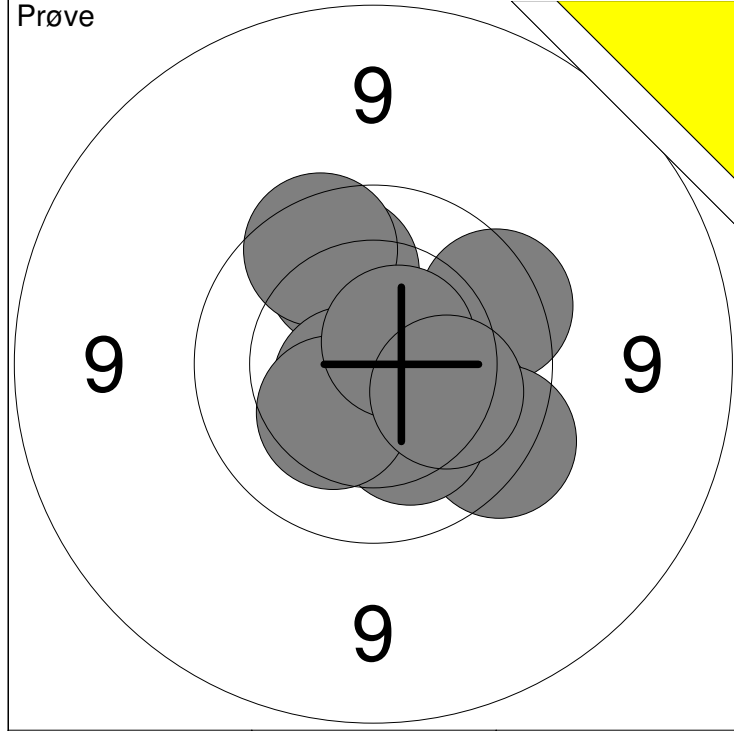

1: 10.0 ↗	6: 10.2 ↘	Serie	97
2: 9.8 →	7: 10.7x ↙		
3: 9.8 ↗	8: 10.3 ↙	Total	0
4: 10.0 ↘	9: 10.6x ↗		
5: 9.7 ↘	10: 10.2 ↘		

11: 9.9 ↘	Serie	49
12: 10.2 ↘		
13: 10.1 ↗	Total	0
14: 10.4 →		
15: 10.3 ←		

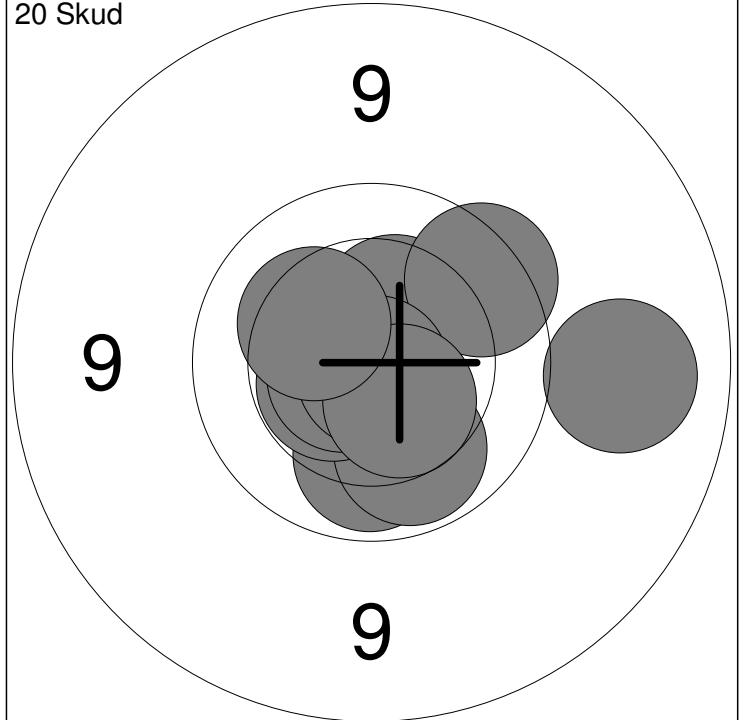
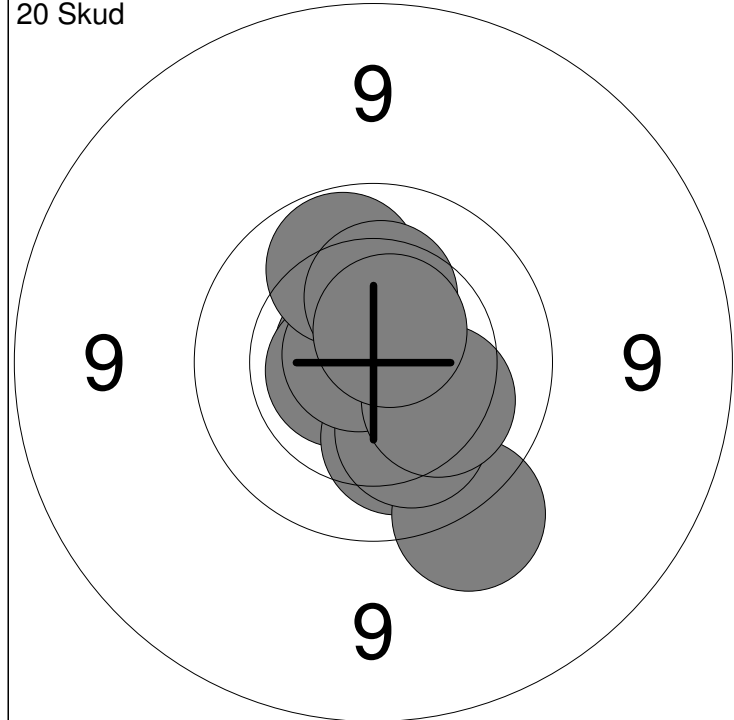

1: 10.7x ↖	6: 10.8x ↖	Serie	99
2: 10.6x ←	7: 10.0 ↗		
3: 10.2 ↘	8: 10.3 ↗	Total	99
4: 9.5 ↘	9: 10.2 ↘		
5: 10.2 ↘	10: 10.6x ↗		

11: 10.0 ↘	16: 9.1 →	Serie	98
12: 10.0 ↘	17: 10.6x ←		
13: 10.4 ↗	18: 10.9x ↘	Total	197
14: 9.8 ↗	19: 10.5 ↘		
15: 10.5x ↙	20: 10.3 ↖		

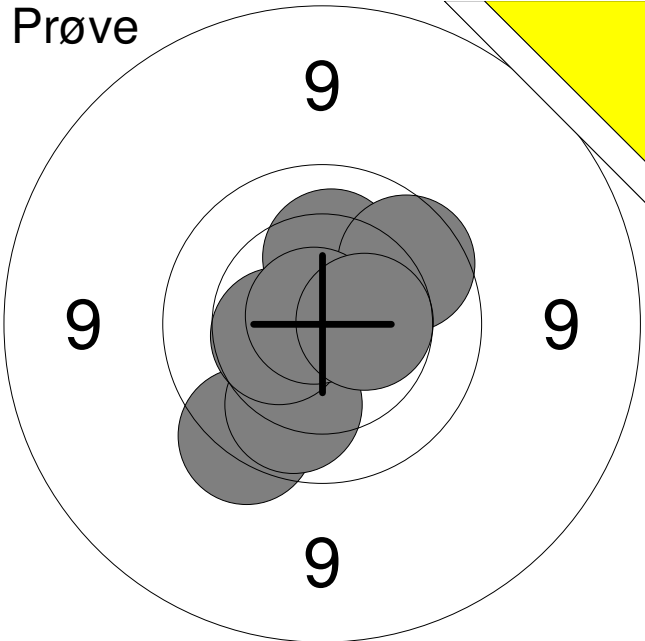
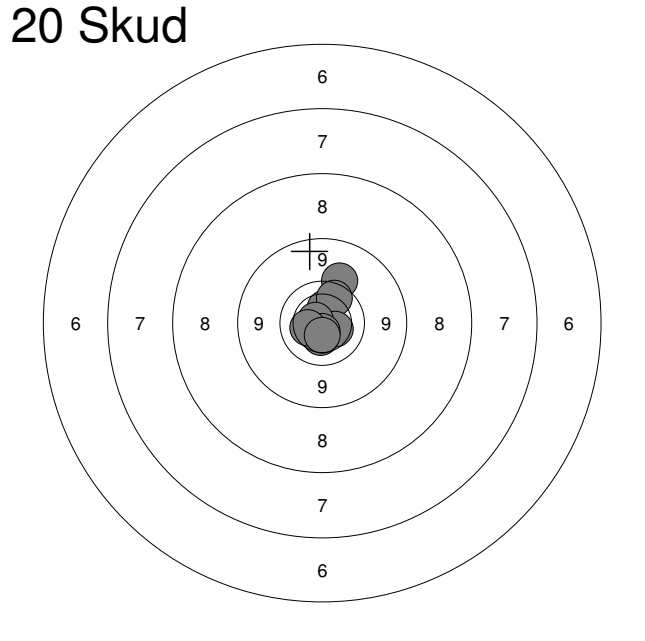
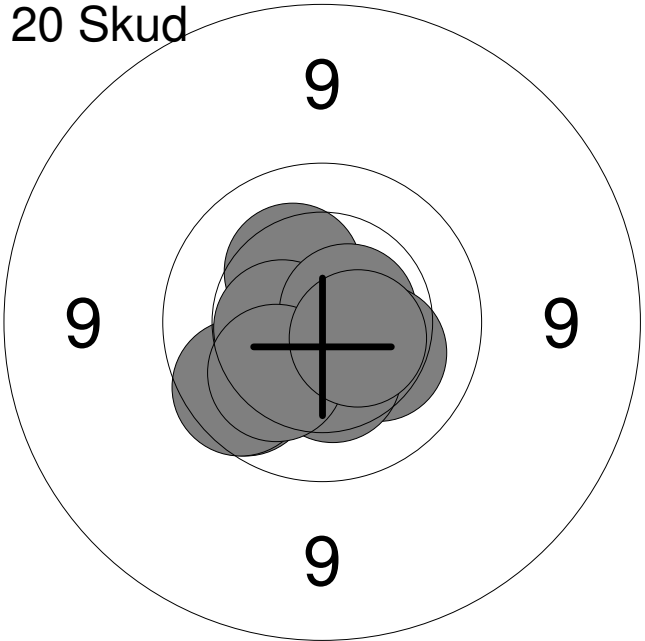
Hold <b>85</b>	Skive <b>9</b>	<b>Fredrik Skov Hansen</b>		
AAS		Aalborg Skyttekreds		BK3
02.02.2017		NM 2017 ungdom riffel		Aalborg Skyttekreds
<b>Prøve</b>				
		1:	10.2	↑
		2:	9.9	↗
		3:	9.7	↘
		4:	10.0	↓
		5:	10.5	←
		6:	10.8x	↖
		7:	10.5	→
		<b>Serie</b>		<b>68.0</b>
		<b>Total</b>		<b>0.0</b>
<b>20 Skud</b>				
		1:	9.4	↖
		2:	10.3	↑
		3:	9.9	↖
		4:	10.4	↘
		5:	10.4	↓
		6:	10.6x	↖
		7:	10.6x	↓
		8:	0.0	↑
		9:	10.3	←
		10:	10.4	↓
		<b>Serie</b>		<b>88.0</b>
		<b>Total</b>		<b>88.0</b>
<b>20 Skud</b>				
		11:	9.9	↖
		12:	10.3	↖
		13:	10.4	↓
		14:	9.9	↖
		15:	10.5x	←
		16:	10.6x	→
		17:	10.2	↘
		18:	10.4	↓
		19:	10.2	↖
		20:	10.5x	↘
		<b>Serie</b>		<b>98.0</b>
		<b>Total</b>		<b>186.0</b>

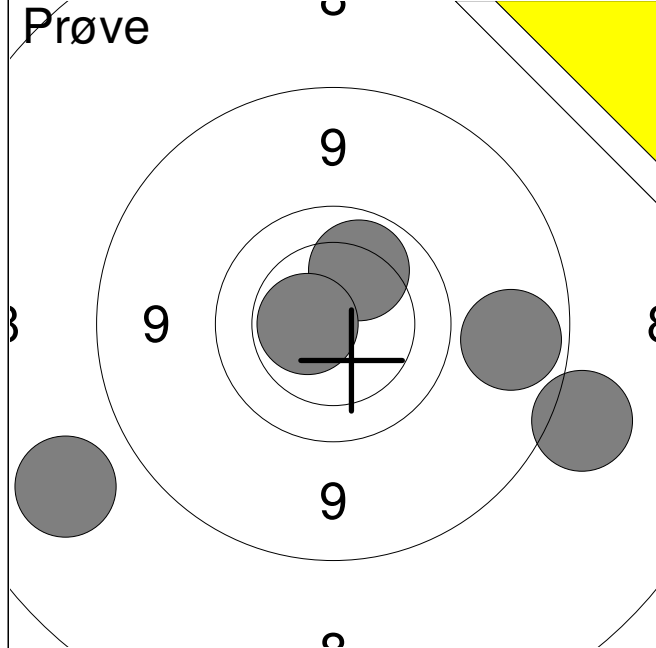

1:	9.0	→
2:	8.2	↙
3:	10.1	↗
4:	8.5	→
5:	10.6x	←
<b>Serie</b>		<b>45.0</b>
<b>Total</b>		<b>0.0</b>

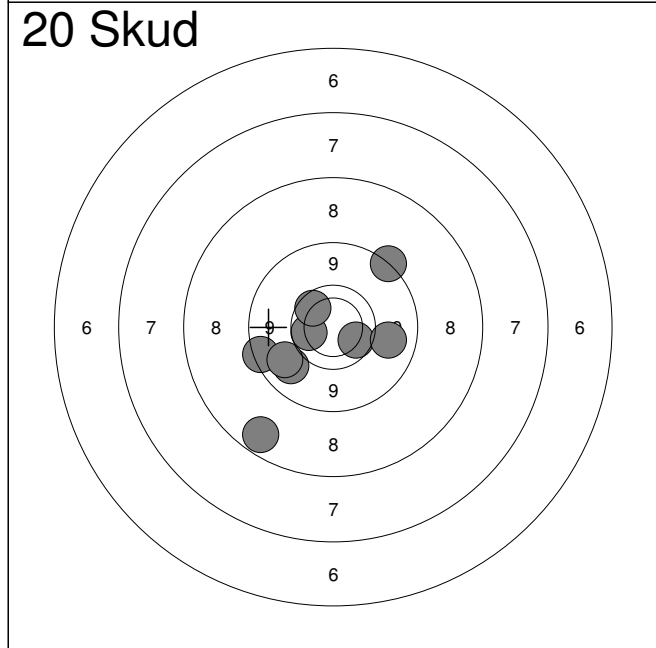

1:	9.9	↘
2:	8.0	↙
3:	8.8	←
4:	9.2	→
5:	8.7	↗
6:	9.2	↙
7:	9.9	←
8:	0.0	↙
9:	9.1	↙
10:	9.9	↗
<b>Serie</b>		<b>78.0</b>
<b>Total</b>		<b>78.0</b>

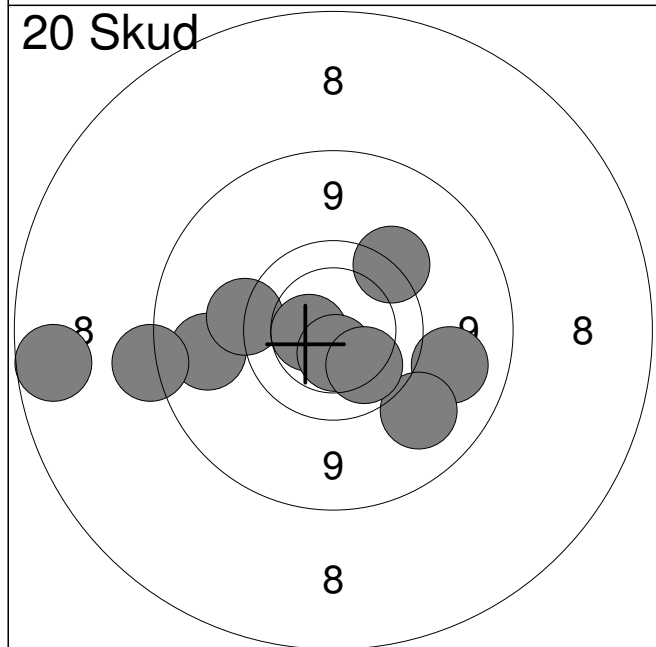

11:	9.2	→
12:	9.5	↗
13:	9.1	←
14:	9.2	↘
15:	9.5	←
16:	10.5	←
17:	7.9	←
18:	10.5x	↓
19:	10.0	↘
20:	8.6	←
<b>Serie</b>		<b>90.0</b>
<b>Total</b>		<b>168.0</b>

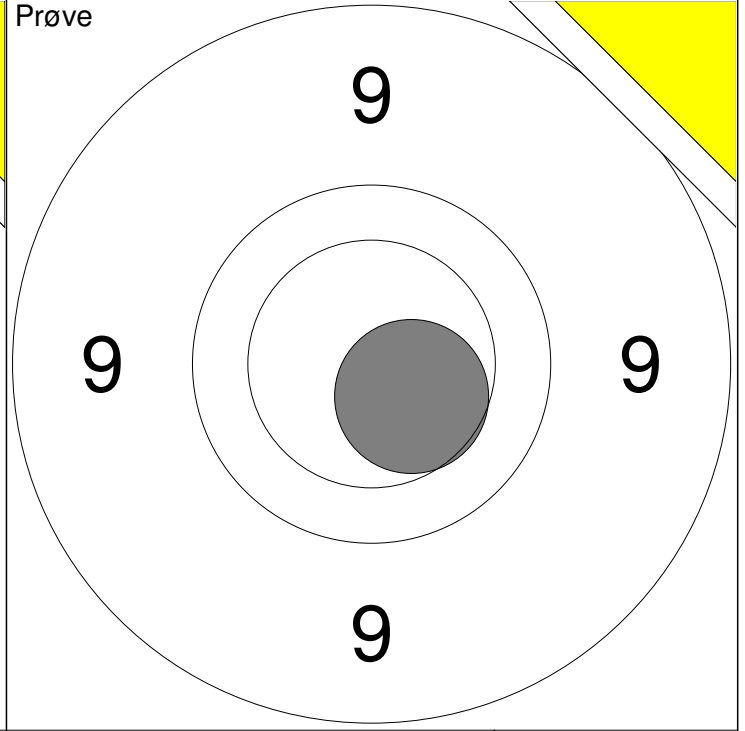
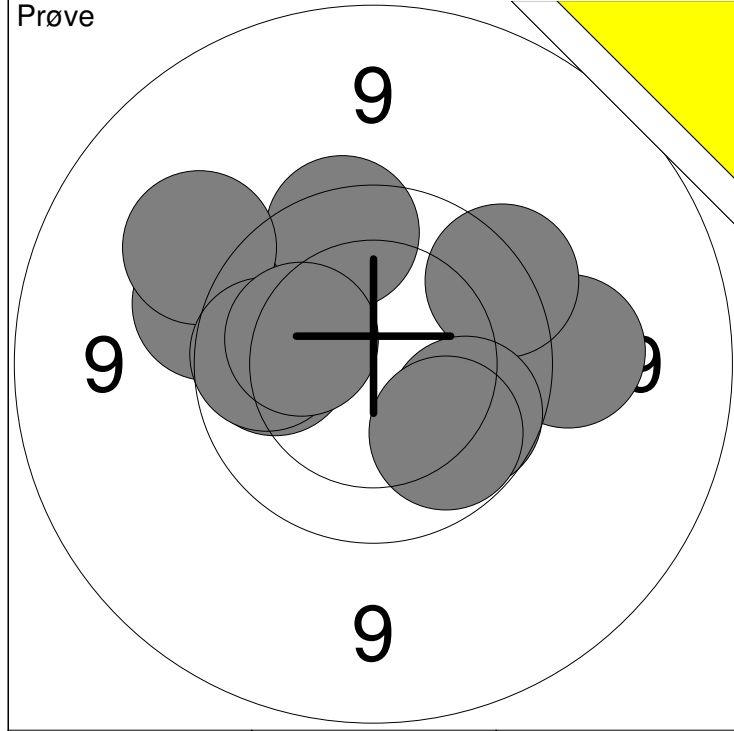

1: 9.4 →	6: 9.9 ←	Serie	93
2: 9.8 ↑	7: 9.7 ↗		
3: 9.5 ←	8: 9.9 ↘	Total	0
4: 9.4 ↗	9: 10.2 ←		
5: 10.0 ←	10: 10.0 ↘		

11: 10.4 ↘	Serie	10
	Total	0

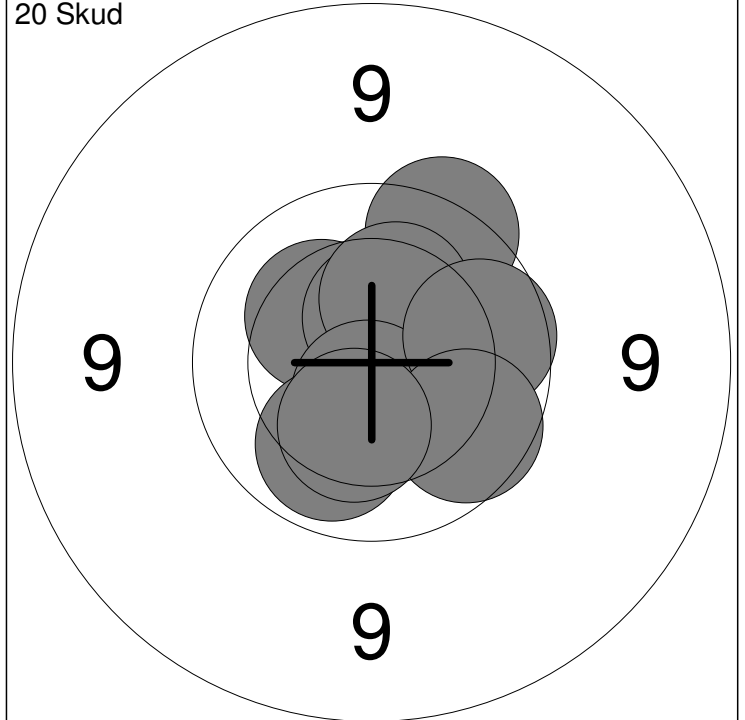
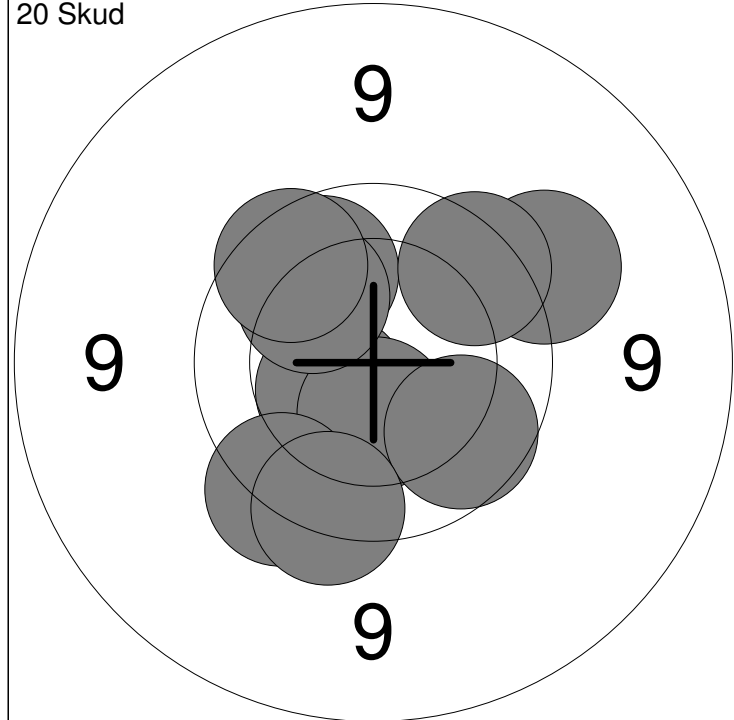

1: 10.5 ↙	6: 9.8 ↗	Serie	93
2: 10.4 ↓	7: 9.4 ↗		
3: 9.6 ↙	8: 9.8 ↗	Total	93
4: 9.9 ↗	9: 9.9 ↘		
5: 10.1 ↗	10: 9.7 ↓		

11: 10.1 ↗	16: 10.6x ↓	Serie	97
12: 10.3 ↙	17: 9.9 →		
13: 10.5x ↑	18: 9.9 ↘	Total	190
14: 9.7 ↗	19: 10.1 ↓		
15: 10.3 ↗	20: 10.3 ↓		



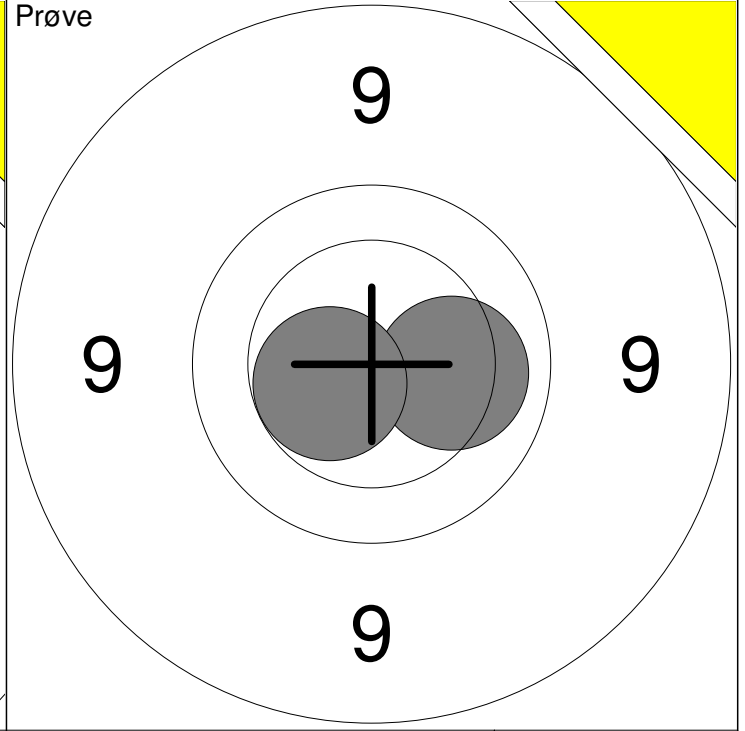
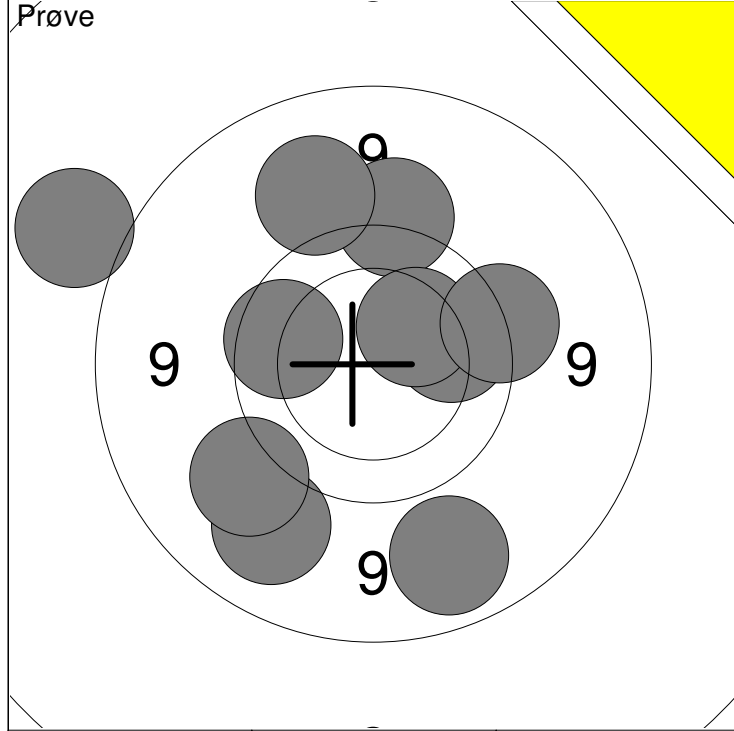

1: 9.1 ↙	6: 9.0 ↓	Serie	90
2: 8.4 ↖	7: 9.9 →		
3: 9.5 ↑	8: 10.2 ↗	Total	0
4: 9.2 ↗	9: 9.6 →		
5: 9.8 ↖	10: 9.3 ↙		

11: 10.2 →	Serie	20
12: 10.5x ↖		
Total		0

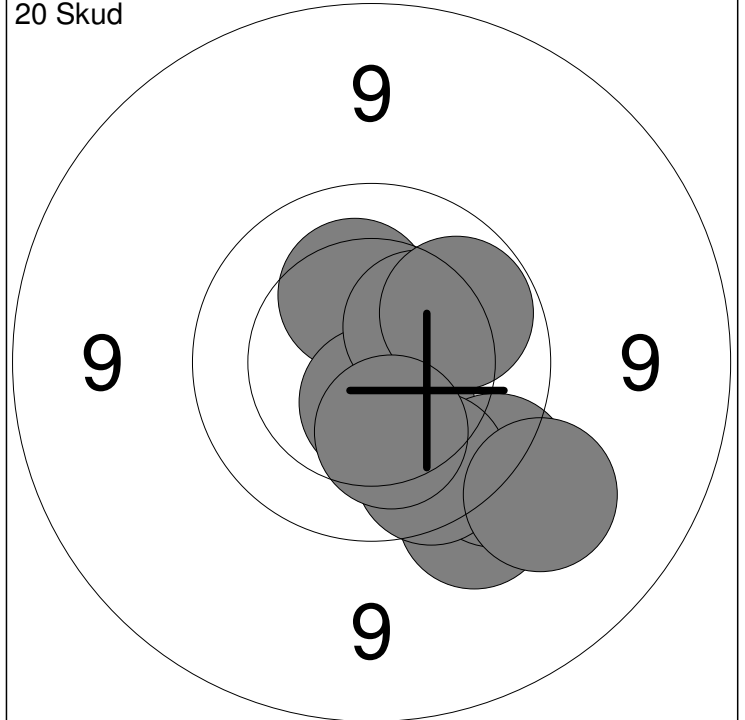
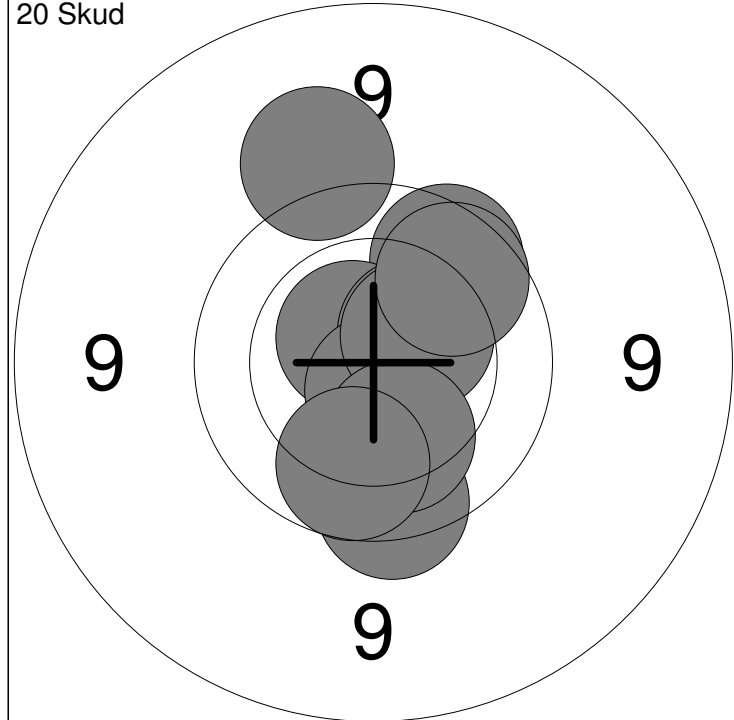

1: 9.8 ↗	6: 9.7 ↓	Serie	95
2: 10.6x ↖	7: 10.2 ↓		
3: 10.5 ↗	8: 9.9 ↓	Total	95
4: 10.7x ↓	9: 9.4 ↗		
5: 10.4 ↗	10: 9.9 ↗		

11: 10.4 ↓	16: 9.8 ↓	Serie	96
12: 9.5 ↓	17: 10.4 ↗		
13: 10.3 ↗	18: 10.0 ↗	Total	191
14: 10.6x ↓	19: 10.2 ↓		
15: 9.6 ↓	20: 9.3 ↓		

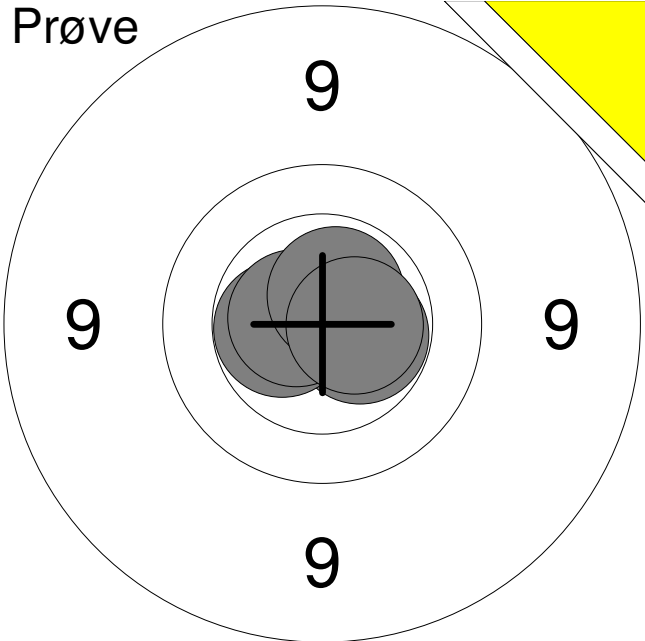
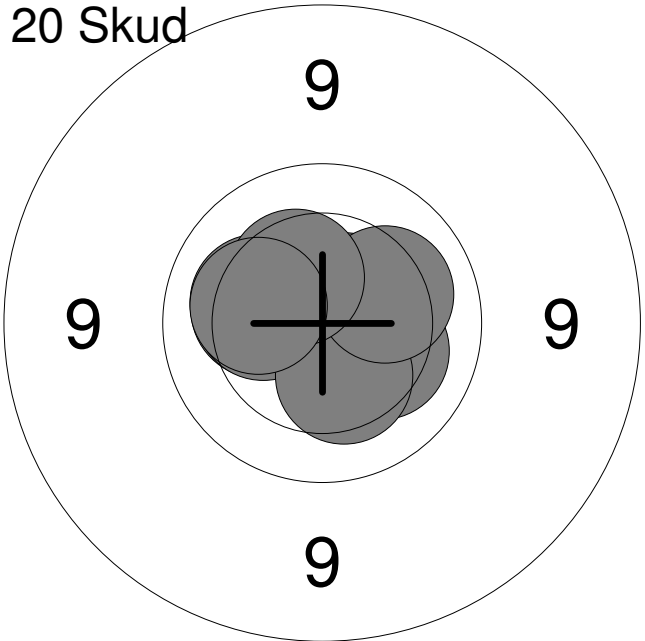
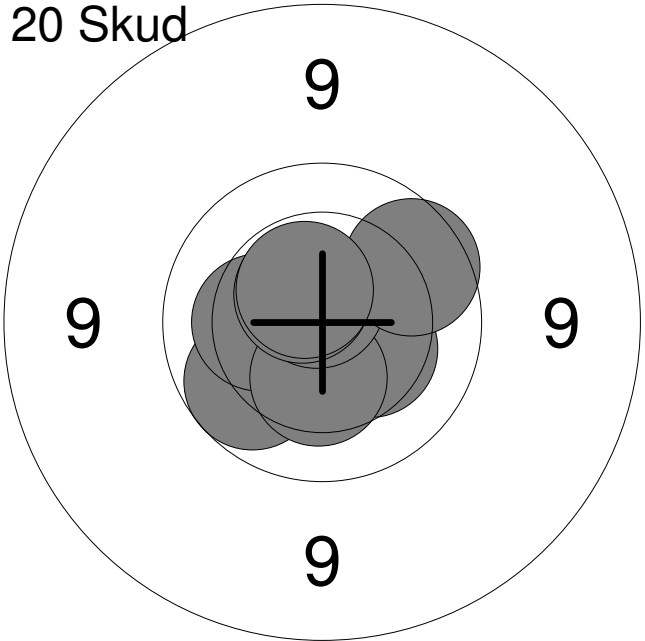
Hold	Skive	Nicklas Christensen		
86	10	Aalborg Skyttekreds		MJ1
02.02.2017	NM 2017 ungdom riffel		Aalborg Skyttekreds	
Prøve		1:	10.5x	→
		2:	10.5x	←
		3:	10.7x	←
		4:	10.6x	↑
		5:	10.6x	→
		Serie		50.0
		Total		0.0
20 Skud		1:	10.7x	↑
		2:	10.2	←
		3:	10.2	←
		4:	10.2	→
		5:	10.3	←
		6:	10.6x	↗
		7:	10.3	↓
		8:	10.2	↗
		9:	10.4	↑
		10:	10.2	←
		Serie		100.0
		Total		100.0
20 Skud		11:	10.5x	→
		12:	9.9	↙
		13:	10.6x	↙
		14:	10.3	←
		15:	10.4	→
		16:	10.3	↓
		17:	10.7x	↑
		18:	10.6x	↗
		19:	9.9	↗
		20:	10.5x	↑
		Serie		98.0
		Total		198.0

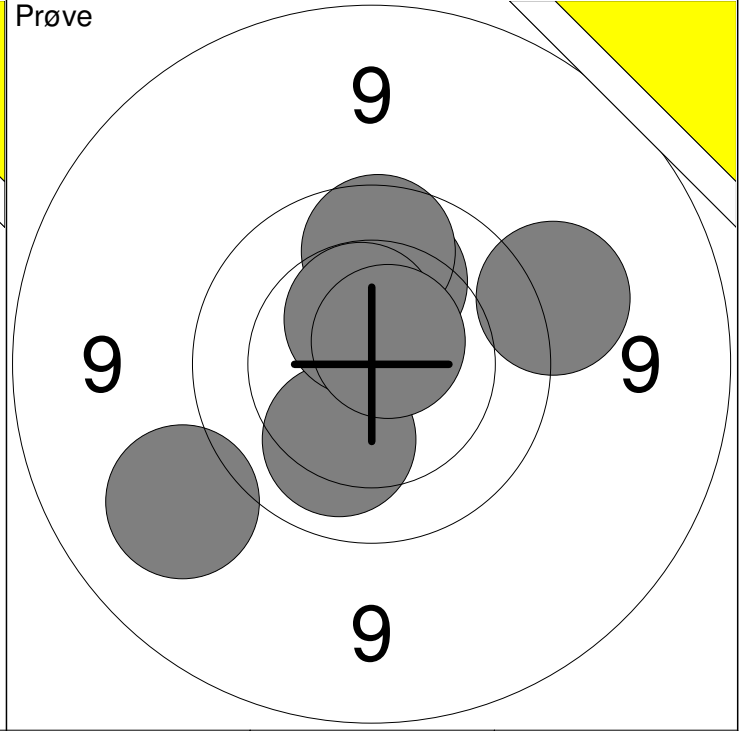
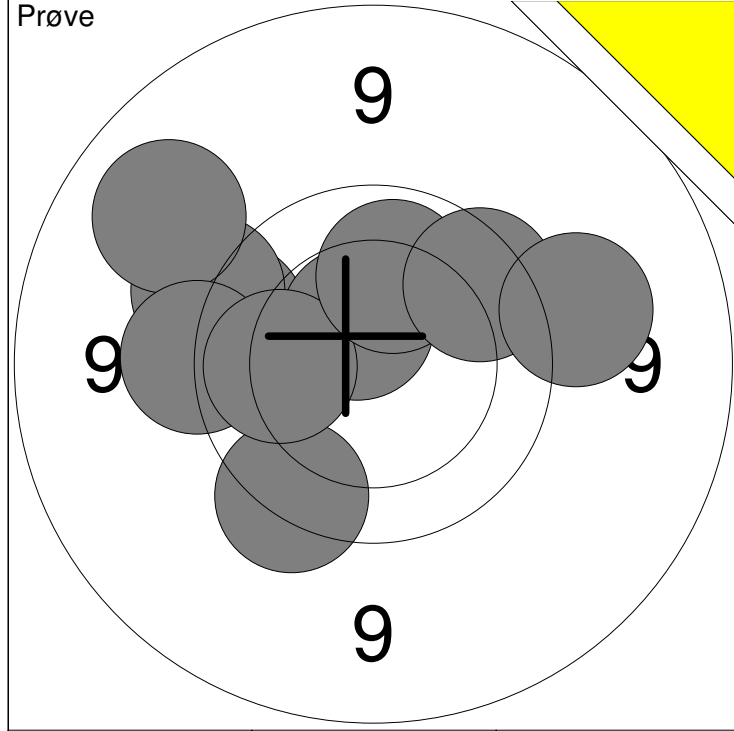

1: 9.7 ↘	6: 10.5x ↗	Serie	93
2: 9.7 ↖	7: 10.0 ←		
3: 9.5 ↗	8: 10.1 ↗	Total	0
4: 9.1 ↗	9: 9.8 ↗		
5: 9.5 ←	10: 9.3 →		

11: 10.1 ↘	16: 9.4 →	Serie	67
12: 10.1 ↗	17: 10.7x ↗		
13: 9.9 ↗		Total	0
14: 9.2 ↘			
15: 10.5x ↗			

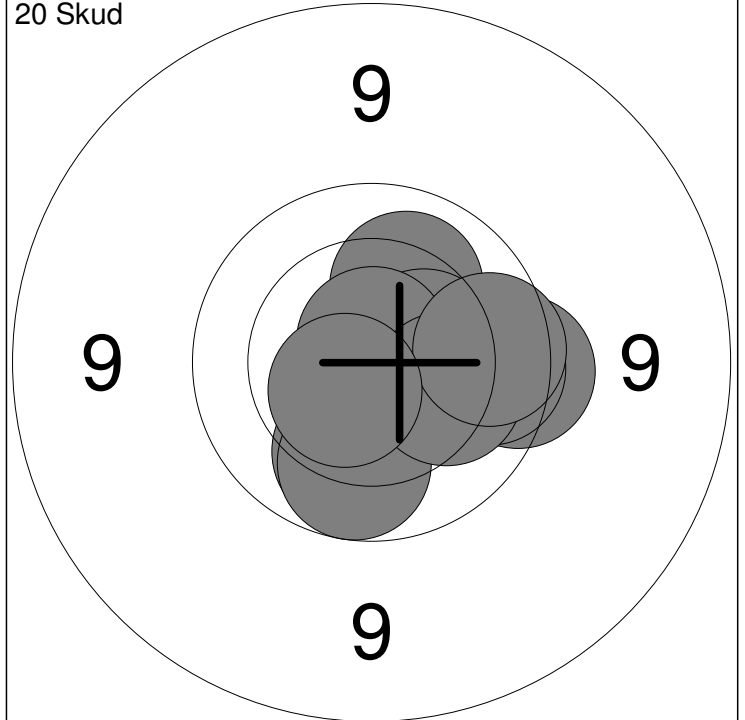
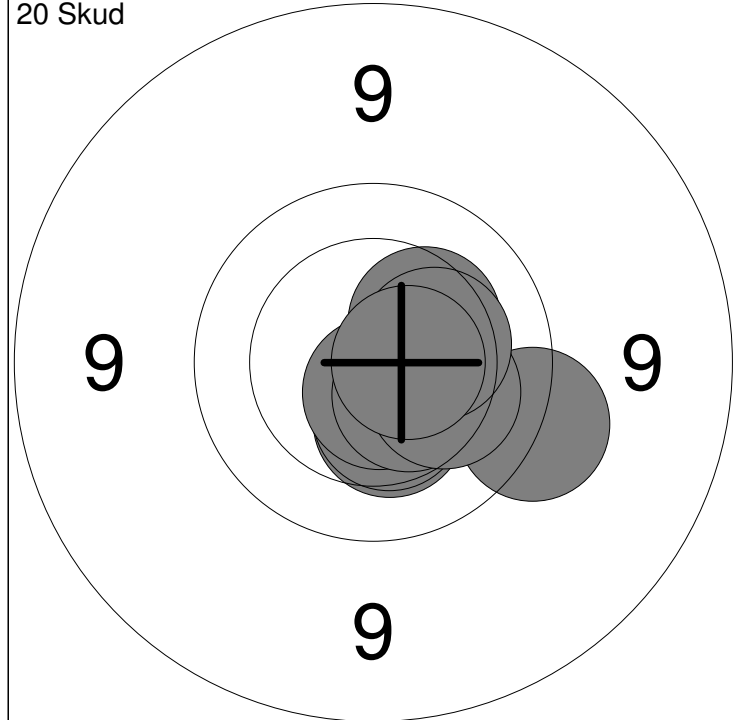

1: 9.6 →	6: 10.4 →	Serie	99
2: 10.3 ↗	7: 10.5 ↘		
3: 10.4 ↘	8: 10.2 ↘	Total	99
4: 10.4 ↘	9: 10.3 →		
5: 10.6x ↘	10: 10.6x →		

11: 10.1 ↗	16: 10.8x ↗	Serie	97
12: 9.7 →	17: 10.0 ↘		
13: 10.4 →	18: 10.2 →	Total	196
14: 9.9 →	19: 9.9 →		
15: 10.0 ↘	20: 10.6x ↘		

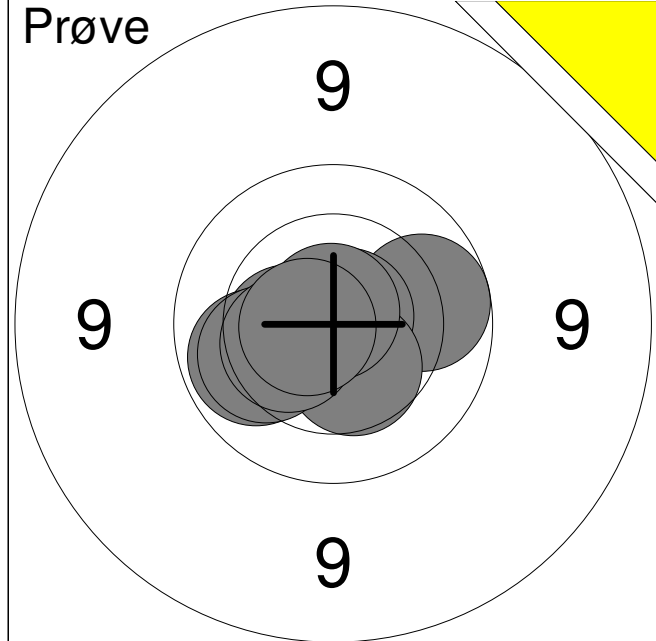

1:	9.9	→
2:	10.8x	↓
3:	10.8x	↗
4:	10.4	↓
5:	10.5	←
6:	10.0	←
7:	10.8x	↑
8:	10.1	←
9:	10.4	←
10:	10.7x	←
<b>Serie</b>	<b>99.0</b>	
<b>Total</b>	<b>0.0</b>	

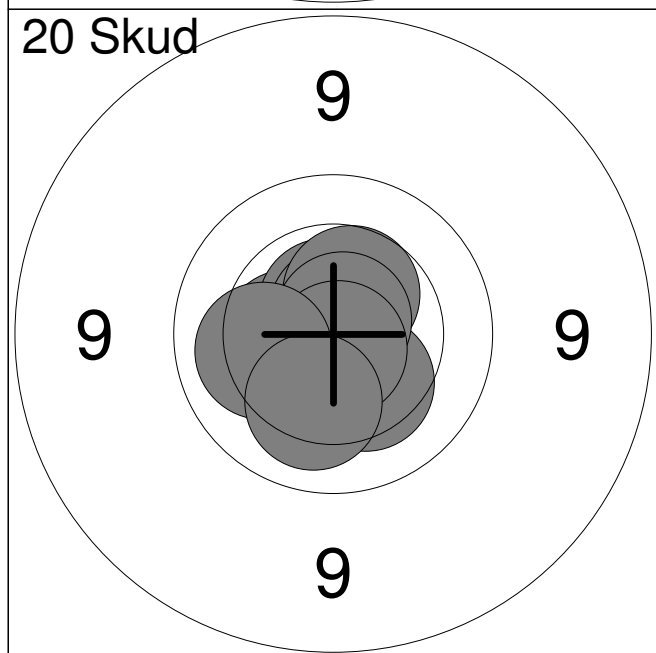

1:	10.5	←
2:	10.6x	↑
3:	10.4	↙
4:	10.3	↓
5:	10.7x	↑
6:	10.5	↗
7:	10.8x	↗
8:	10.8x	↓
9:	10.2	←
10:	10.2	↓
<b>Serie</b>	<b>100.0</b>	
<b>Total</b>	<b>100.0</b>	

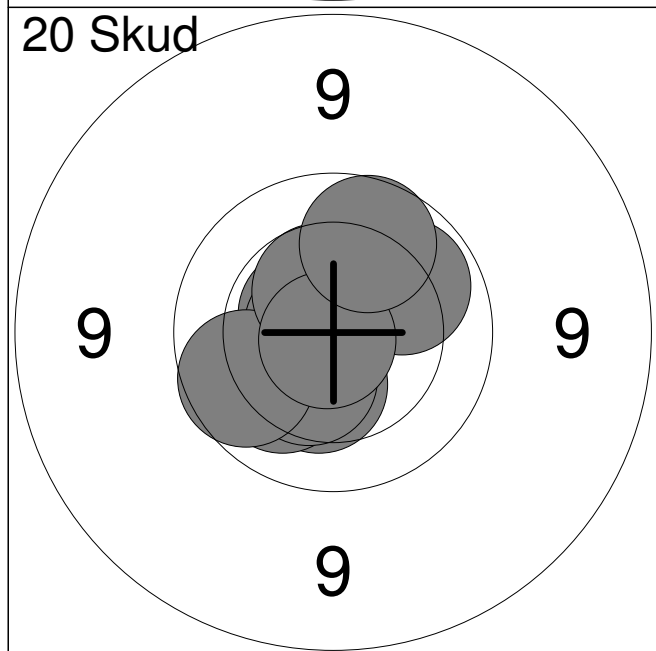

11:	10.6x	↖
12:	10.4	↓
13:	10.2	↙
14:	10.4	↓
15:	10.7x	←
16:	9.9	←
17:	10.0	↗
18:	10.5	↑
19:	10.8x	↙
20:	9.9	↑
<b>Serie</b>	<b>98.0</b>	
<b>Total</b>	<b>198.0</b>	

<b>Prøve</b> 	1:	10.7x	→
	2:	10.4	←
	3:	10.6x	↓
	4:	10.5x	←
	5:	10.6x	←
	6:	9.9	↘
	7:	10.4	→
	8:	10.4	↓
	<b>Serie</b>		<b>79.0</b>
	<b>Total</b>		<b>0.0</b>

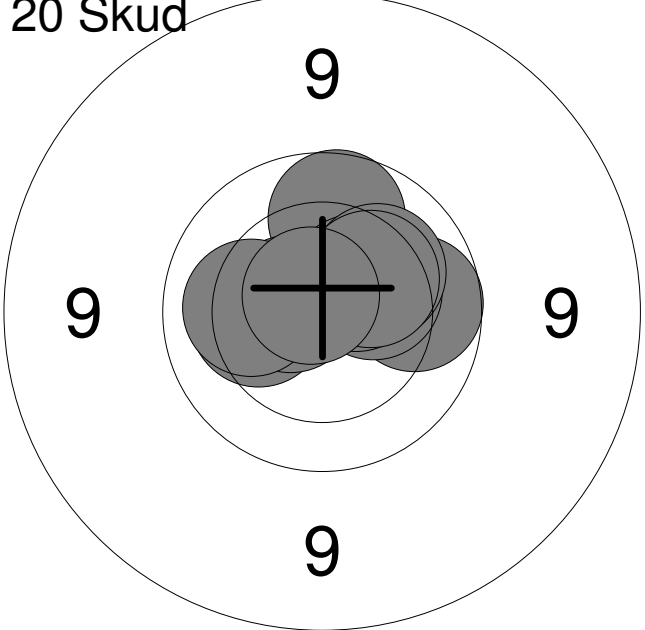
<b>20 Skud</b> 	1:	9.9	→
	2:	10.3	→
	3:	9.9	↑
	4:	10.5	↗
	5:	10.2	↗
	6:	10.2	←
	7:	10.6x	←
	8:	10.2	←
	9:	10.3	↗
	10:	10.7x	↖
<b>Serie</b>		<b>98.0</b>	
<b>Total</b>		<b>98.0</b>	

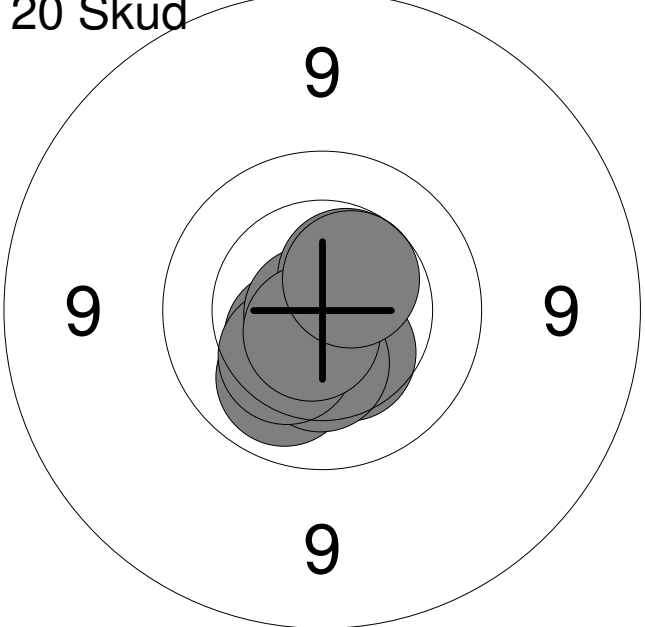
<b>20 Skud</b> 	11:	10.7x	↓
	12:	10.4	↓
	13:	10.1	↓
	14:	10.5x	←
	15:	10.4	↓
	16:	10.3	↘
	17:	10.8x	←
	18:	10.5x	↗
	19:	10.7x	↓
	20:	10.5	↗
<b>Serie</b>		<b>100.0</b>	
<b>Total</b>		<b>198.0</b>	

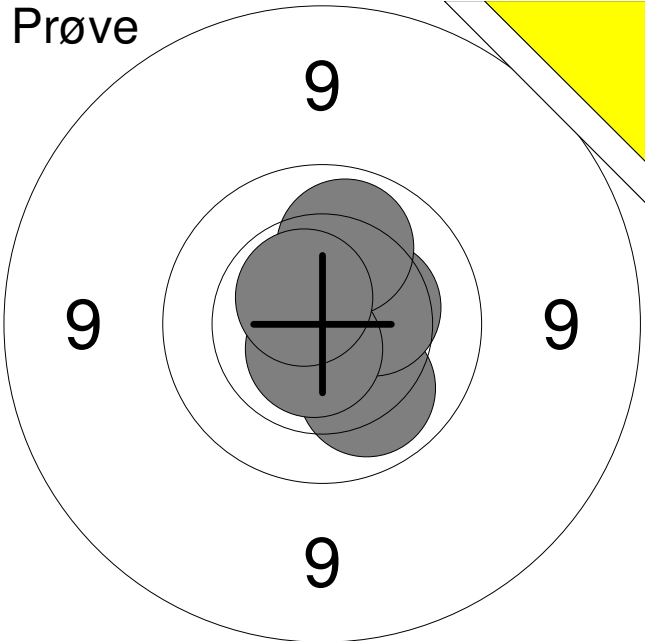
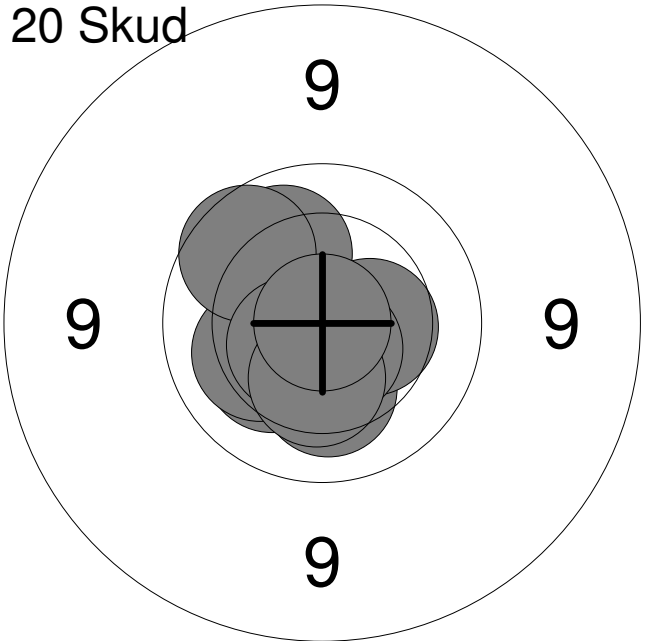
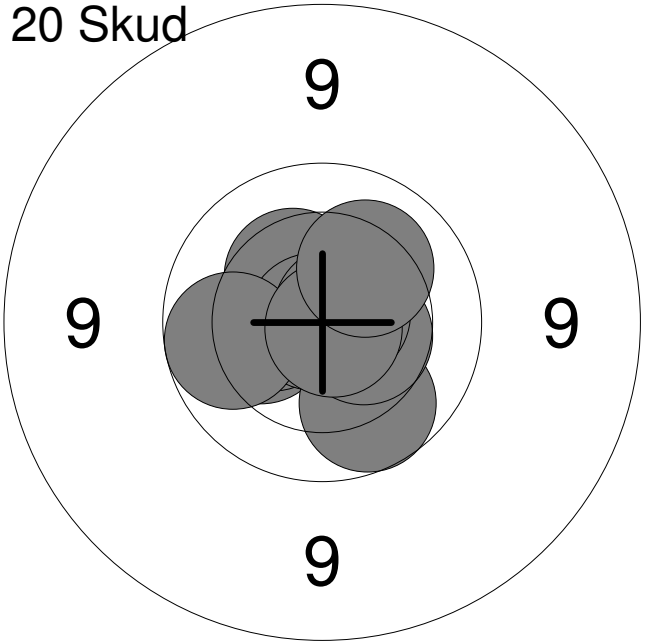
Hold <b>87</b>	Skive <b>9</b>	<b>Fredrik Skov Hansen</b>		
AAS		Aalborg Skyttekreds		MB3
02.02.2017		NM 2017 ungdom riffel		Aalborg Skyttekreds
<b>Prøve</b> 		1: 10.1	↘	
		2: 10.4	→	
		3: 10.1	↑	
		4: 10.7x	↘	
		5: 10.6x	↗	
		<b>Serie</b>	<b>50.0</b>	
		<b>Total</b>	<b>0.0</b>	
<b>20 Skud</b> 		1: 10.2	↙	
		2: 10.2	↓	
		3: 10.1	↗	
		4: 10.4	→	
		5: 10.2	↙	
		6: 9.9	↗	
		7: 10.6x	↓	
		8: 10.6x	↙	
		9: 10.3	↓	
		10: 10.9x	↑	
		<b>Serie</b>	<b>99.0</b>	
		<b>Total</b>	<b>99.0</b>	
<b>20 Skud</b> 		11: 10.3	↙	
		12: 10.4	↙	
		13: 9.9	↓	
		14: 10.3	↗	
		15: 10.9x	↙	
		16: 9.9	↙	
		17: 10.5	→	
		18: 10.7x	↗	
		19: 10.8x	↘	
		20: 10.2	↗	
		<b>Serie</b>	<b>98.0</b>	
		<b>Total</b>	<b>197.0</b>	

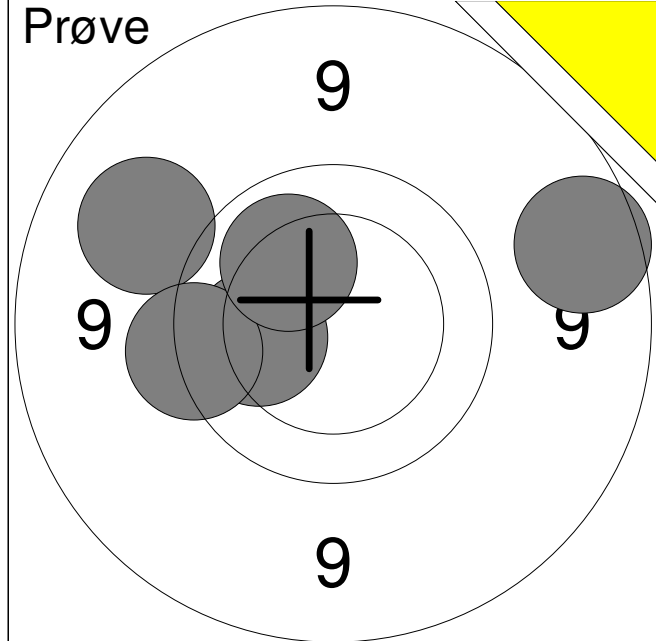

1:	10.1	←
2:	9.2	↖
3:	9.6	←
4:	8.9	→
5:	10.1	↗
<b>Serie</b>	<b>46.0</b>	
<b>Total</b>	<b>0.0</b>	

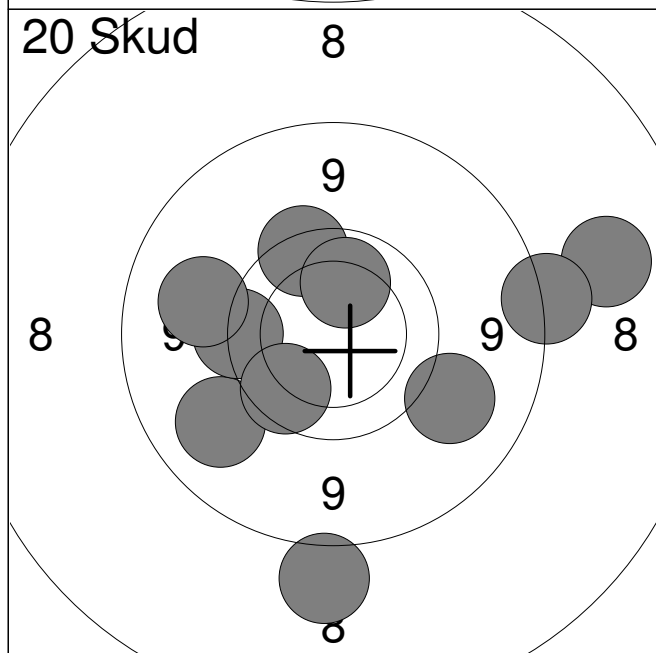

1:	9.2	↙
2:	8.2	→
3:	8.6	→
4:	9.6	←
5:	9.3	←
6:	9.3	↘
7:	9.7	↗
8:	9.8	↙
9:	8.5	↓
10:	10.1	↗
<b>Serie</b>	<b>88.0</b>	
<b>Total</b>	<b>88.0</b>	

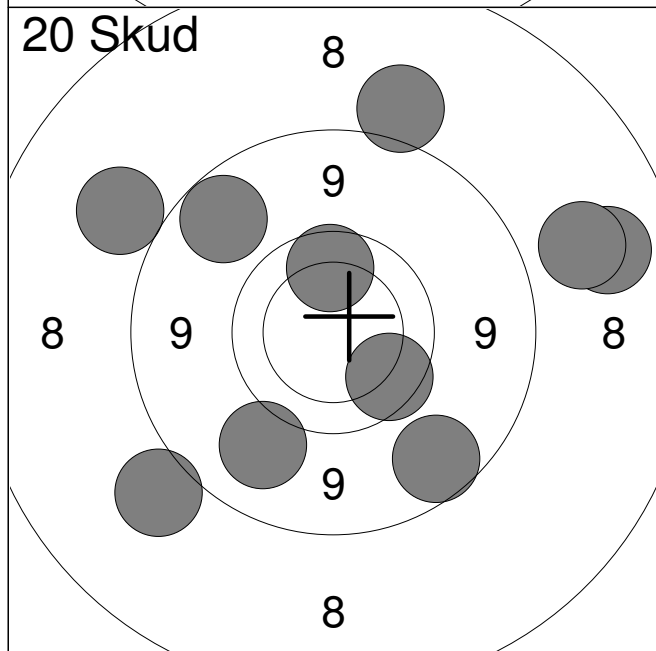

11:	9.8	↘
12:	9.2	↙
13:	8.5	↗
14:	8.4	↙
15:	8.4	↖
16:	9.9	↗
17:	8.1	→
18:	8.9	↘
19:	8.3	→
20:	9.0	↗
<b>Serie</b>	<b>84.0</b>	
<b>Total</b>	<b>172.0</b>	

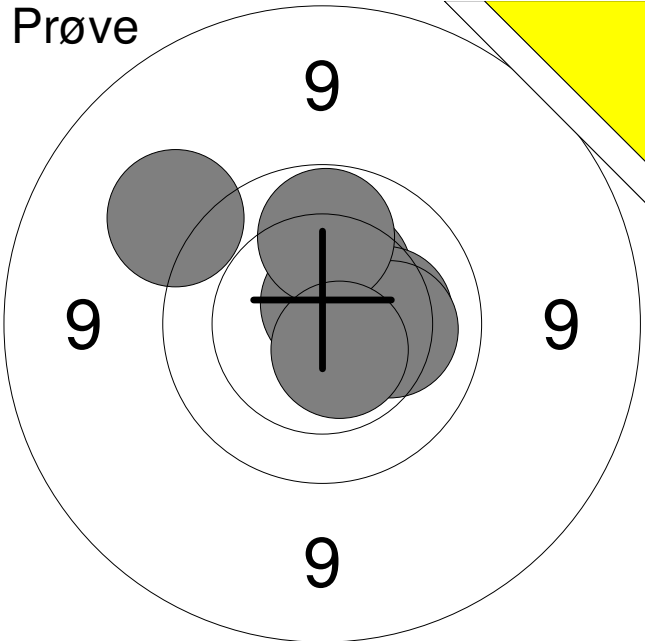
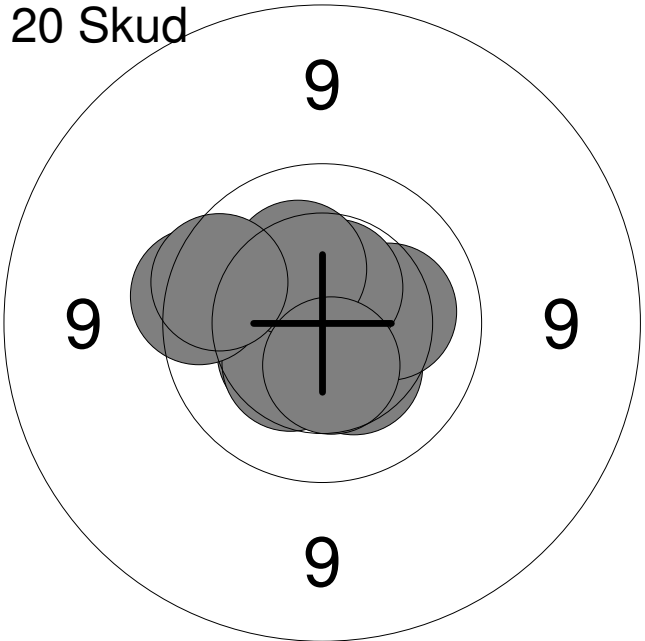
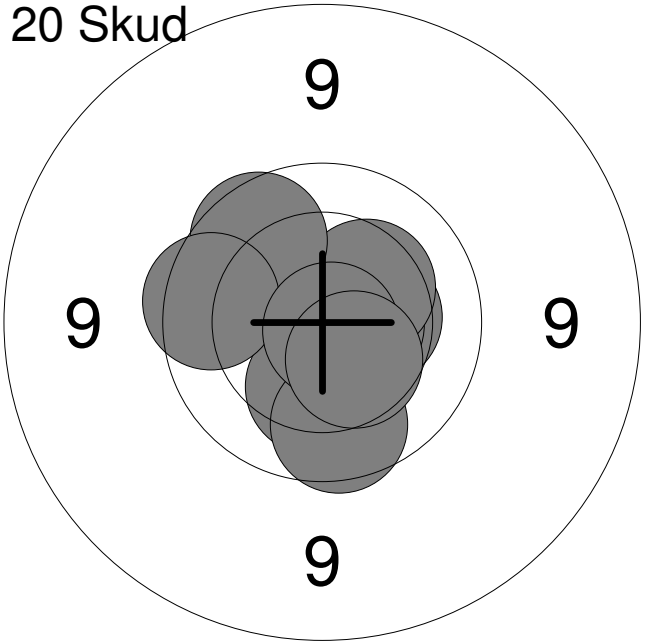
Hold	Skive		
87	12	Niklas Pedersen	
AAS		Aalborg Skyttekreds	MJ2
02.02.2017	NM 2017 ungdom riffel	Aalborg Skyttekreds	
Prøve		1: 10.4	↗
		2: 9.4	↖
		3: 10.3	→
		4: 10.7x	↗
		5: 10.2	→
		6: 10.0	↗
		7: 10.6x	↘
		Serie	69.0
		Total	0.0
20 Skud		1: 10.4	↘
		2: 10.8x	↖
		3: 10.4	↖
		4: 10.2	→
		5: 10.4	↘
		6: 10.5x	↗
		7: 10.3	↗
		8: 9.7	↖
		9: 10.5	↘
		10: 9.8	↖
		Serie	98.0
		Total	98.0
20 Skud		11: 10.4	→
		12: 10.6x	↘
		13: 10.2	↘
		14: 10.6x	→
		15: 10.3	↗
		16: 9.9	↗
		17: 9.9	↘
		18: 9.8	↖
		19: 10.8x	↘
		20: 10.4	↘
		Serie	97.0
		Total	195.0